

**ASKO**  
Inspired by Scandinavia



---

## **INSTRUCTIONS FOR USE**

Coffee machine  
EN

CM8478G  
CM8478GG

# Contents

<b>Pictograms used</b> .....	<b>3</b>	Clean all components of the milk container .....	25
<b>Safety</b> .....	<b>4</b>	Clean the appliance's internal circuit .....	25
<b>Your coffee machine</b> .....	<b>7</b>	Clean the coffee grounds container .....	26
Dear customer! .....	7	Clean the drip tray .....	26
Description of the appliance .....	8	Clean the inside of the coffee machine .....	27
Touch keys and symbols .....	11	Clean the water tank .....	27
<b>Operation</b> .....	<b>14</b>	Clean the coffee spouts .....	27
Before first use .....	14	Clean the pre-ground coffee funnel .....	27
Set your appliance to 'On' .....	15	Descalc the appliance .....	28
Set your appliance to 'Standby' and 'Off' .....	16	Set the water hardness .....	29
Important tips and tricks when you make coffee .....	16	Install a water softener filter .....	30
Make coffee using coffee beans .....	16	Replace a water softener filter .....	31
Make coffee using pre-ground coffee .....	17	Remove a water softener filter .....	31
Adjust the grind level .....	17	Clean the brewing unit/infuser once a month .....	31
Make milk-based hot drinks .....	18	Clean the brewing unit/infuser twice a year .....	33
Make two cups of coffee .....	19	Use the milk cleaner .....	35
Customise beverages .....	19	<b>Troubleshooting</b> .....	<b>37</b>
Supply a beverage that is customised .....	19	<b>Environmental aspects</b> .....	<b>39</b>
Customise a user profile .....	20	Disposal of the appliance and packaging .....	39
Supply hot water or steam .....	20	<b>Installation</b> .....	<b>40</b>
<b>Settings</b> .....	<b>21</b>	<b>Safety</b> .....	<b>40</b>
Settings menu .....	21	Dimensions .....	41
<b>Maintenance</b> .....	<b>23</b>	Built-in .....	42
Clean your appliance .....	23	<b>Your notes</b> .....	<b>44</b>
Clean the hot water spout .....	23		
Clean the internal tubes of the milk container and the nozzle .....	24		

## Pictograms used

The following symbols are used throughout the manual, and they have the following meanings:

 INFORMATION!

**Information, advice, tip, or recommendation**

 WARNING!

**Warning – general danger**

 ELECTRIC SHOCK!

**Warning – danger of electric shock**

 HOT SURFACE!

**Warning – danger of hot surface**

 DANGER OF FIRE!

**Warning – danger of fire**

 RIGHT!

 WRONG!

It is important that you carefully read the instructions.

# Safety

 WARNING!

READ CAREFULLY AND KEEP IT FOR FUTURE REFERENCE!

## What you should pay attention to

 WARNING!

The appliance and its accessible parts become hot during use. Care should be taken to avoid touching heating elements.



- This appliance can be used by children aged from 8 years and above and persons with reduced physical, sensory or mental capabilities or lack of experience and knowledge if they have been given supervision or instruction concerning use of the appliance in a safe way and understand the hazards involved.
- Appliances can be used by persons with reduced physical, sensory or mental capabilities or lack of experience and knowledge if they have been given supervision or instruction concerning the use of the appliance in a safe way and understand the hazards involved.
- Children should be supervised to ensure that they do not play with the appliance.
- Do not allow children to clean or maintain the appliance unless supervised.
- Always disconnect the appliance from the supply if it is left unattended and before assembling, disassembling or cleaning.



Surfaces marked with this symbol become hot during use (the symbol is present in certain models only).

 WARNING!

The filling aperture must not be opened during use.

-  **WARNING!**  
Avoid spillage on the connector.
-  **WARNING!**  
There is a possibility of injury when there is a misuse of the appliance.
- Heating element surfaces are subjected to residual heat after use.
-  **WARNING!**  
Do not use the appliance if the glass surface is cracked.
- Never immerse the appliance in water.
- This is a household appliance only. It is not intended to be used in: staff kitchen areas in shops, offices and other working environments; farm houses; by clients in hotels, motels and other residential type environments; bed and breakfast type environments.
- If the supply cord is damaged, it must be replaced by the manufacturer, its service agent or similarly qualified persons in order to avoid a hazard.
- Do not lean or hang on the machine when it has come out of the cabinet and do not place heavy or unstable objects on the machine.
- The manufacturer is not liable for damage caused by improper, incorrect or unreasonable use of the appliance.
- When using the appliance, do not touch the hot surfaces. Use the knobs or handles.
- In case of failures, make sure the appliance is not connected to the mains power supply. Refer to our service department for repairs.
- Only ask for original spare parts to be used. Failure to respect the above could reduce the safety of the appliance.

## Safety

- Do not put objects containing liquids, inflammable or corrosive materials on the machine.
- Use the accessories holder to contain coffee accessories (for example coffee beans).
- Never touch the appliance with damp hands.
- Unplug directly from the plug only.
- Never pull the power cable as you could damage it.

### **Designated use**

- This appliance is intended for domestic use only (around 3000 cups a year). Any other use is considered improper and in that case, no guarantee will be given.
- This appliance is designed to “make espresso coffee” and “heat drinks”. Use it with care to avoid scalds from the water and steam jets or through incorrect use.
- This appliance is designed and made to prepare beverages based on coffee, milk and hot water. Only use drinking water in the tank. Never use the accessories to make beverages other than those described in these instructions. Any other use is considered improper and thus dangerous. The manufacturer is not liable for damage deriving from improper use of the appliance.
- Clean all the components thoroughly, taking particular care with parts in contact with the milk.
- **IMPORTANT:** To prevent damage to the appliance, do not clean with alkaline detergents; use a soft cloth and, where applicable, neutral detergent.

# Your coffee machine

Dear customer!

Welcome to our growing ASKO family!

We are proud of our appliances. We hope that this appliance will be an appreciated and dependable aid for many years to come.

Please read the operating instructions before use. They include general tips, information about the settings and adjustments you can make, and the best way to take care of your appliance.

## TIP!

You can find the most recent version of the instructions for use on our website.

Enjoy your cooking!

# Your coffee machine

## Description of the appliance



- A. My profile
- B. Settings
- C. User profile
- D. Selected aroma
- E. Time
- F. Selected size
- G. Aroma
- H. Size
- I. Scroll left/right
- J. Beverages available to select



*When this primary screen is shown, the appliance is ready to use.*

# Your coffee machine

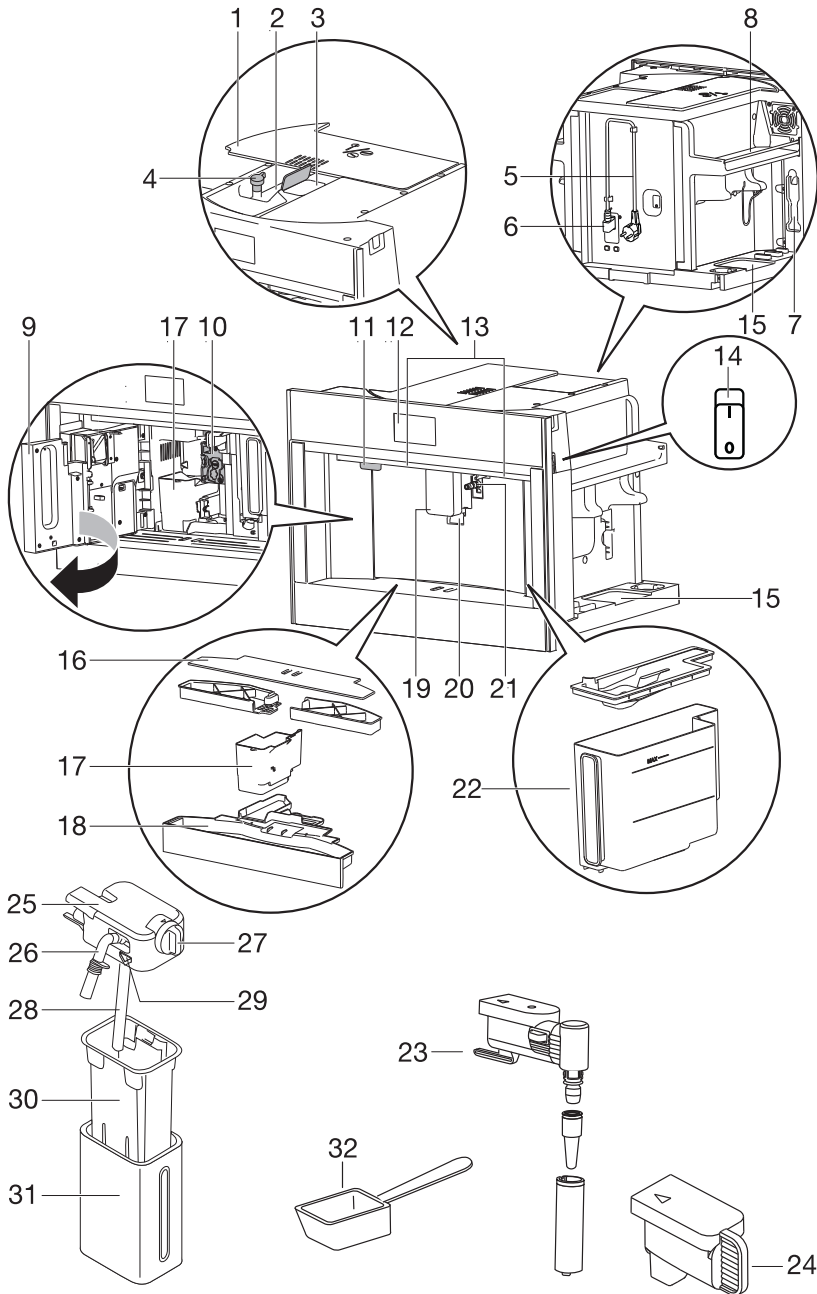











# Your coffee machine

1. Lid bean container
2. Bean container
3. Ground coffee funnel (with lid)
4. Knob to adjust the grind level
5. Power cord
6. IEC connector
7. Area for the measuring spoon
8. Cup warming area
9. Service door
10. Brewing unit
11. On/Standby button
12. Control panel
13. Lighting
14. Main switch
15. Area for accessories (left and right)
16. Cup tray
17. Coffee grounds container
18. Drip tray with level indicator
19. Coffee spouts (adjustable height)
20. Cup lights
21. Hot water connection nozzle
22. Water tank
23. Hot water spout
24. Cover connection nozzle
25. Lid with a milk frother
26. Frothed milk spout (adjustable)
27. Milk froth adjustment knob
28. Milk intake tube
29. Release button
30. Milk container
31. Thermal casing
32. Measuring spoon for pre-ground coffee

## **Maintenance set**









- 'Total Hardness Test' indicator paper
- Descaler
- Water softener filter (certain models only)
- Cleaning brush/cleaning cloth
- Milk cleaner
- O-rings and lubricating grease

## Touch keys and symbols

















Touch keys	
	<p><b>My profile</b></p> <p>Customise several beverage settings for the user profile that is shown on the primary screen.</p> <ul style="list-style-type: none"> <li>• See chapter 'Customise beverages'.</li> <li>• You cannot use this touch key when the guest profile is shown on the display.</li> </ul>
	<p><b>Settings</b></p> <ul style="list-style-type: none"> <li>• See chapter 'Settings menu'.</li> </ul>
	<p><b>User profile</b></p> <p>Touch this key to select the correct user profile. Six different user-profiles and a guest profile are available.</p> <ul style="list-style-type: none"> <li>• If you select a beverage that has been customised for this profile, it will be supplied with the customised saved settings. See chapter 'Supply a beverage that is customised'.</li> <li>• If you select the guest profile, beverages will be supplied with the default settings.</li> </ul>
	<p><b>Customise a user profile</b></p> <ul style="list-style-type: none"> <li>• See chapter 'Customise a user profile'.</li> </ul>
	<p><b>Aroma</b></p> <ul style="list-style-type: none"> <li>• Touch this key (several times) to select 'Pre-ground' or to select the aroma.</li> </ul>
	<p><b>Size</b></p> <ul style="list-style-type: none"> <li>• Touch this key (several times) to select the coffee quantity.</li> </ul>
	<p><b>Scroll left/right</b></p> <ul style="list-style-type: none"> <li>• Touch these keys until the correct variable is shown on the display.</li> </ul>
	<p><b>OK</b></p>
	<p><b>Stop</b></p>
	<p><b>Escape</b></p> <p>Cancel or go back one step.</p> <ul style="list-style-type: none"> <li>• Values will not be saved.</li> </ul>

# Your coffee machine

Table continued from last page

Touch keys	
 Next	<b>Next</b>
 Minus (-) / Plus (+)	<b>Minus (-) / Plus (+)</b> <ul style="list-style-type: none"><li>Adapt the aroma when you customise a beverage.</li></ul>
 Start	<b>Start</b>
 Enter	<b>Enter</b> <ul style="list-style-type: none"><li>Enter a menu.</li></ul>
 Double espresso	<b>Double espresso</b> <ul style="list-style-type: none"><li>This touch key is shown on the display for a few seconds at the start of preparing one espresso.</li></ul>
 Extra	<b>Extra</b> <ul style="list-style-type: none"><li>Increase the quantity of water of the beverage that is being prepared.</li></ul>
 On/Off	<b>On/Off</b> <ul style="list-style-type: none"><li>The setting is 'off'.</li></ul>
 On/Off	<b>On/Off</b> <ul style="list-style-type: none"><li>The setting is 'on'.</li></ul>

# Your coffee machine

Symbols	
	<b>My aroma (if programmed) / Standard</b>
	<ul style="list-style-type: none"> <li>• Pre-ground</li> </ul>
	<ul style="list-style-type: none"> <li>• Extra light</li> </ul>
	<ul style="list-style-type: none"> <li>• Light</li> </ul>
	<ul style="list-style-type: none"> <li>• Medium</li> </ul>
	<ul style="list-style-type: none"> <li>• Strong</li> </ul>
	<ul style="list-style-type: none"> <li>• Extra strong</li> </ul>
	<b>My quantity (if programmed) / Standard</b>
	<ul style="list-style-type: none"> <li>• Small</li> </ul>
	<ul style="list-style-type: none"> <li>• Medium</li> </ul>
	<ul style="list-style-type: none"> <li>• Large</li> </ul>
	<ul style="list-style-type: none"> <li>• Extra large</li> </ul>
	<b>Settings saved</b>
	<b>Default value</b>
	<b>Auto-start function enabled</b>
	<b>Energy-saving enabled</b>
	<b>Filter enabled</b>

# Operation

## Before first use

Remove the packaging. Make sure the product is complete and undamaged. Check if all accessories are present. Do not use the appliance if it is visibly damaged. Contact the service department if there are any problems.

### NOTE!

- Coffee has been used to test the appliance in the factory. Therefore it is completely normal that there are traces of coffee in the mill.
- Customise the water hardness as soon as possible. Obey the instructions in chapter 'Set the water hardness'.

### TIP!

To improve the performance of your appliance, we recommend installing a water softener filter. If your model is not provided with a filter, you can purchase one from the service department.

### NOTE!

- Always use clean and cold tap water, bottled water without added minerals or distilled water suitable for consumption.
- The first time you use the appliance, the water circuit is empty. The appliance could be very noisy. The noise becomes less when the circuit fills with water.
- The first time you use the appliance, you need to make 4-5 cups of coffee before it starts to give results that are satisfactory.
- When making the first 5-6 beverages, it is normal to hear the noise of boiling water. This noise becomes less during use.
- Pull the appliance forward to get access to the main switch, the area for accessories and the lid of the bean container. Pull the coffee spouts forward to open the service door.
- Use the accessories holder to contain coffee accessories (for example coffee beans).

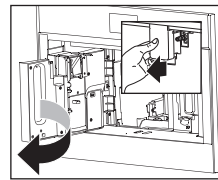
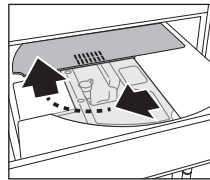
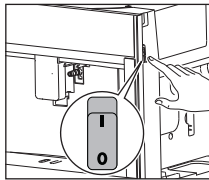
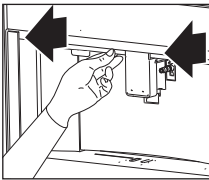

### NOTE!

Read and obey the instructions shown on the display. The display shows information and touch keys to use. Important information is accompanied by an audio signal.

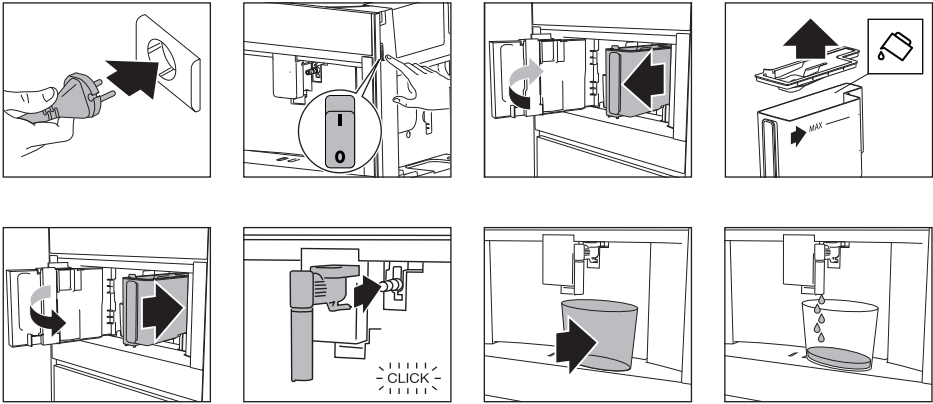

The appliance goes to standby automatically. It is now ready for normal use.

## ⚠ WARNING!

### Danger! Risk of burns.

During rinsing, a little hot water flows out of the coffee spouts. Avoid contact with splashes of water. Do not let the appliance stay unattended while hot water is being supplied.

## Set your appliance to 'On'



The appliance is ready to use if it has reached the correct temperature.

The primary screen is shown.

## NOTE!

Each time the appliance is set to 'On', it performs an automatic preheat and rinse cycle. This cycle cannot be interrupted. The appliance is ready for use only after the completion of this cycle.

## TIP!

Put a cup under the spouts. Collect the hot water from the rinse cycle to warm the cup.

## NOTE!

Do not push the main switch while the appliance is set to 'On'.

# Operation

## Set your appliance to 'Standby' and 'Off'

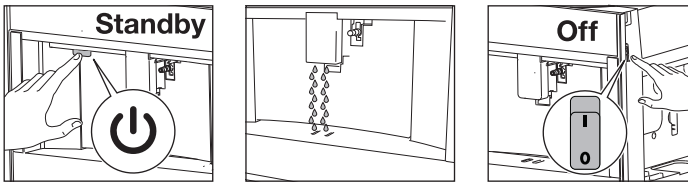

### NOTE!

Each time the appliance is set to 'Standby' after being used to make coffee, it performs an automatic rinse cycle.

### TIP!

- If you do not use the appliance for a long period, set the appliance to 'Off'.
- To disconnect the appliance completely, place the main switch on the side of the appliance in the 0 (off) position.

## Important tips and tricks when you make coffee

- The supply of coffee can be stopped at any moment.
- As soon as the supply has ended, you can increase the quantity of water.
- You can customise beverages.
- Adjust the grind level if the coffee is supplied a drop at a time or too weak and not creamy enough.
- Make a hotter coffee:
  - Perform a rinse cycle and warm the cups with the hot water from the rinse cycle.
  - Supply hot water to warm the cups.
  - Use the cup warmer setting to warm the cups.
  - Increase the coffee temperature.
- Lower the spouts to the cup as near as possible. This makes the coffee more creamy.
- After the coffee supply, the aroma setting and the quantity setting are reset to the 'original recipe'.
- Once a beverage has been made, the appliance is ready to make the next beverage.

## Make coffee using coffee beans

### NOTE!

Do not use green, caramelised or candied coffee beans. They could make the coffee mill unusable.

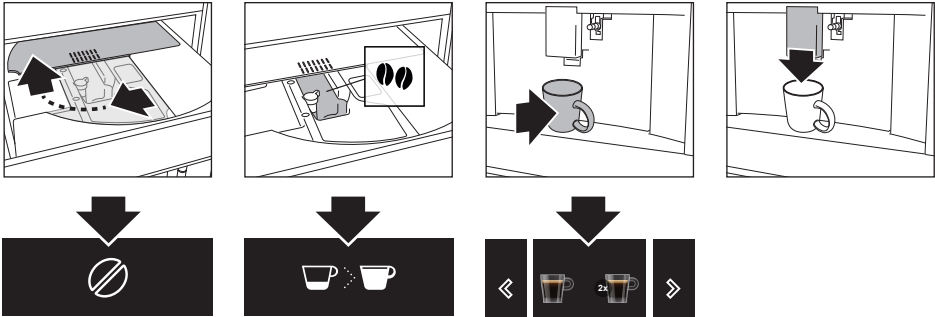

## Make coffee using pre-ground coffee

### NOTE!

- Only add pre-ground coffee when the appliance is set to 'On'. Otherwise, the coffee could spread through the inside of the appliance and damage it.
- Only make one cup of coffee at a time. Do not use more than 1 measuring spoon.
- Make sure the funnel is not blocked (see chapter 'Maintenance').

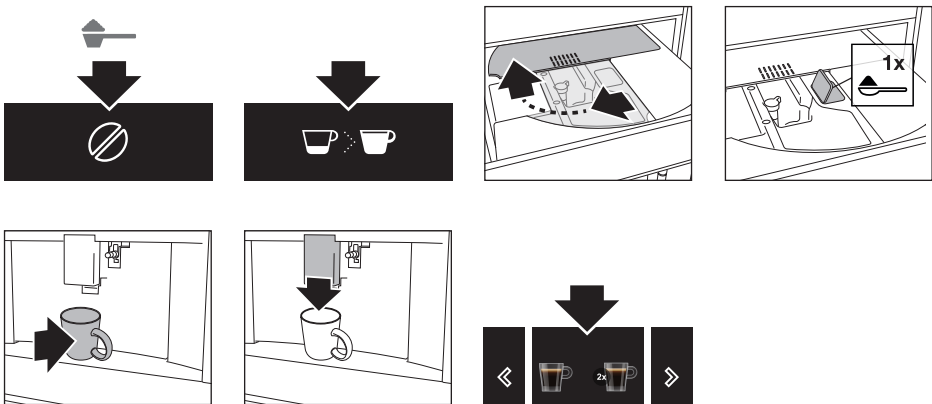

## Adjust the grind level

The coffee mill is set by default to prepare coffee correctly. It should not require regulating initially. However, you can adjust the grind level:

# Operation

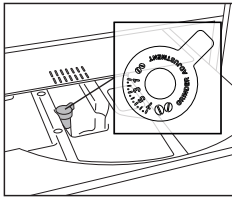

- if the coffee is supplied too slowly or not at all.
  - Turn the knob one click clockwise in the direction of 7.
- for a stronger, creamier coffee.
  - Turn the knob one click anti-clockwise in the direction of 1.



## NOTE!

- Only turn the knob when the coffee mill is operating (during the start of the coffee preparation). Turn the knob one click at a time. When you have made at least 2 cups of coffee, turn the knob another click if the adjustment did not give the desired result.

## Make milk-based hot drinks

### TIP!

- Use skimmed or partially skimmed milk at refrigerator temperature (about 5 °C) to get a richer denser froth.

Dial position	Description	Recommended for...
	No froth	Caffe latte / Hot milk
	Min. Froth	Latte macchiato
	Max. froth	Cappuccino / Frothed milk

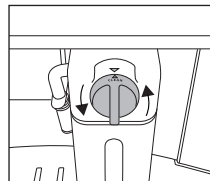
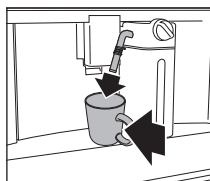
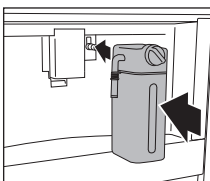
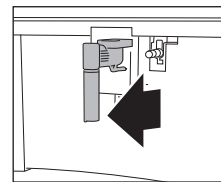
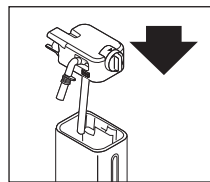
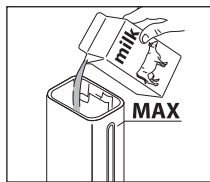
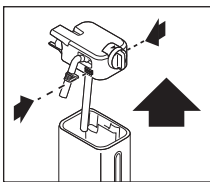

## NOTE!

After the supply of a milk-based hot drink, the display shows a CLEAN message (see chapter 'Maintenance').

## Make two cups of coffee

With this appliance, you can make a perfect espresso or coffee. To guarantee the quality of each cup, we have chosen not to offer the option of two cups of coffee at the same time.

## Customise beverages

The appliance allows you to choose six different profiles, each associated with a different icon. For every beverage, the customized aroma and amount can be saved in a profile.

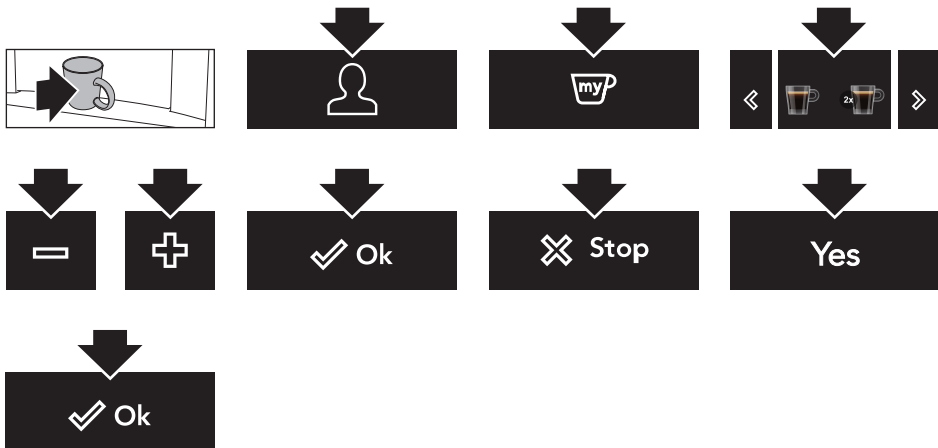

## Supply a beverage that is customised

Make sure the primary screen shows the correct user profile. If you select a beverage that has been customised for this profile, it will be supplied with the customised saved settings.

### TIP!

The order in which all the beverages for a user profile are displayed is based on the frequency of selection.



### TIP!

If you select the guest profile, beverages will be supplied with the default settings.

# Operation

## Customise a user profile



## Supply hot water or steam

 **HOT SURFACE!**

### **Danger! Risk of burns.**

- Do not let the appliance stay unattended while hot water or steam is being supplied.
- Avoid burns from splashes. Always stop the hot water or steam supply before removing the cup containing the liquid.

### **TIP!**

Use steam to heat or froth liquid. Immerse the hot water spout in the liquid. When the required temperature or level of froth is reached, stop the steam supply.

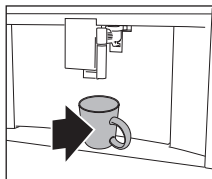
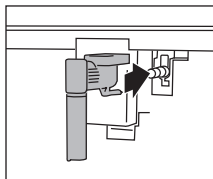

### **TIP!**









#### **Tips when you use steam to froth milk**

- When choosing the size of the cup, bear in mind that the liquid doubles or triples in volume.
- For a creamier froth, rotate the cup with slow movements up and down.

### **NOTE!**

Clean the hot water spout each time you used it to froth milk (see chapter 'Maintenance').

## Settings menu

	<p><b>Rinsing</b></p> <p>Clean and heat the appliance's internal circuit. Supply hot water from the coffee spouts and hot water spout (if inserted).</p> <ul style="list-style-type: none"> <li>Put a container with a minimum capacity of 100 ml under the coffee and hot water spouts.</li> </ul>
	<p><b>Descaling</b></p> <p>See chapter 'Maintenance'.</p>
	<p><b>Water filter</b></p> <p>See chapter 'Maintenance'.</p>
	<p><b>Drink settings</b></p> <p>Consult your customised settings for each profile. Reset the default values for each beverage.</p> <ul style="list-style-type: none"> <li>See also 'Default values' for more information.</li> </ul>
	<p><b>Set time</b></p> <p>Adjust the time shown on the display.</p>
	<p><b>Auto-start</b></p> <p>Set the auto-start time. At that time, the appliance is ready to make coffee immediately.</p> <ul style="list-style-type: none"> <li>To use this setting, make sure that the time of the day is correctly set.</li> <li>The corresponding symbol is displayed adjacent to the time to indicate that the setting is on.</li> </ul>
	<p><b>Auto-off (standby)</b></p> <p>Set the time for the appliance to go to standby.</p>
	<p><b>Cup warmer</b></p> <p>The fan blows hot air into the cup warmer area.</p> <ul style="list-style-type: none"> <li>The residual heat of the appliance is used for heating up the cup. The heating result is depending on the time the machine is set to 'On'.</li> </ul>
<b>ECO</b>	<p><b>Energy saving</b></p> <p>Energy consumption is decreased in compliance with European regulations.</p> <ul style="list-style-type: none"> <li>The corresponding symbol is displayed adjacent to the time to indicate that the setting is on.</li> <li>You may have to wait a few seconds before the first coffee is supplied.</li> </ul>

# Settings

Table continued from last page

	<b>Coffee temperature</b> Adjust the temperature of the water that is used to make coffee.
	<b>Water hardness</b> See chapter 'Maintenance'.
	<b>Set language</b> Adjust the language shown on the display.
	<b>Beep</b> Set the beep on or off. <ul style="list-style-type: none"><li>You hear a beep every time you touch a key and when you insert/remove an accessory.</li></ul>
	<b>Lighting</b> Set the lighting on or off. <ul style="list-style-type: none"><li>The cup lighting comes on each time a beverage is supplied and during each rinse cycle.</li></ul>
	<b>Background</b> Set the colour of the display background.
<b>DEMO</b>	<b>Demo mode</b> Start the demo mode to show the main functions. <ul style="list-style-type: none"><li>To exit the demo mode, set your appliance to 'Standby'.</li></ul>
	<b>Default values</b> Reset all menu settings and programmed quantities back to the default values (with the exception of the language).
	<b>Statistics</b> Show statistics relating to the appliance.

## Clean your appliance

### ⚠ WARNING!

Read and obey the instructions shown on the display. The display shows information and touch keys to use. Important information is accompanied by an audio signal.

### NOTE!

- Do not use solvents, abrasive detergents, alcohol or chemical products to clean the appliance!
- Do not use metal objects to remove encrustations or coffee deposits. They could scratch metal or plastic surfaces.
- Only the milk container is dishwasher safe. Do not clean the other components of the appliance in the dishwasher!

### Regular cleaning

- The hot water spout (each time you used it to froth milk).
- The internal tubes of the milk container and the hot water connection nozzle (each time a milk-based hot drink is supplied).
- The milk container and all the components (about once a month).
- The appliance's internal circuit.
- The coffee grounds container.
- The drip tray.
- The inside of the coffee machine (about once a month).
- The water tank (about once a month and when you replace the water softener filter).
- The coffee spouts.
- The pre-ground coffee funnel (about once a month).
- The brewing unit and the infuser (at least once a month).

### Special cleaning

- Twice a year you must disassemble the brewing unit, clean the parts and lubricate the O-rings of the brewing unit and the infuser (see 'Clean the brewing unit/infuser twice a year').
- Each time the milk container is empty, we recommend cleaning all components using the milk cleaner (see 'Use the milk cleaner').

## Clean the hot water spout

Clean the hot water spout each time you used it to froth milk. This avoids the build-up of milk residues and prevents it from clogging.

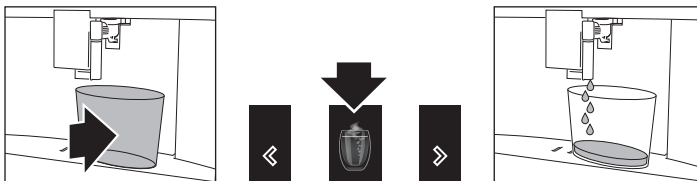

# Maintenance

## HOT SURFACE!

Wait a few minutes for the hot water spout to cool down.

## NOTE!

Wash all parts of the spout thoroughly with a sponge and warm water.

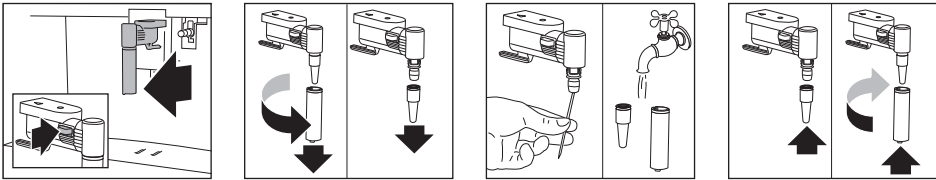

## Clean the internal tubes of the milk container and the nozzle

Each time a milk-based hot drink is supplied, the display shows a CLEAN message. Put an empty cup under the milk spout before you obey this instruction shown on the display. Let the milk container stay in the appliance (you do not need to empty it).

## WARNING!

### **Danger! Risk of burns.**

When cleaning the internal tubes of the milk container, a little hot water and steam leak out of the frothed milk spout. Avoid contact with splashes of water.



*The cleaning stops automatically.*

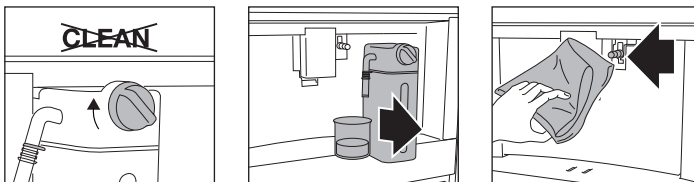

*Any milk residues are removed now.*

## NOTE!

- To prepare a number of cappuccinos and milk-based coffees, only confirm the CLEAN message after you have prepared the last beverage. To proceed with making the next beverages, touch the escape key.
- If you touch the escape key, a symbol is shown on the display to remind you that the internal tubes of the milk container need cleaning.

## Clean all components of the milk container

### ⚠ WARNING!

The thermal casing must not be filled with or immersed in water. Clean with a damp cloth only.

Wash all the components of the frother thoroughly with hot water and light washing-up liquid.

## NOTE!

Only the milk container is dishwasher safe.

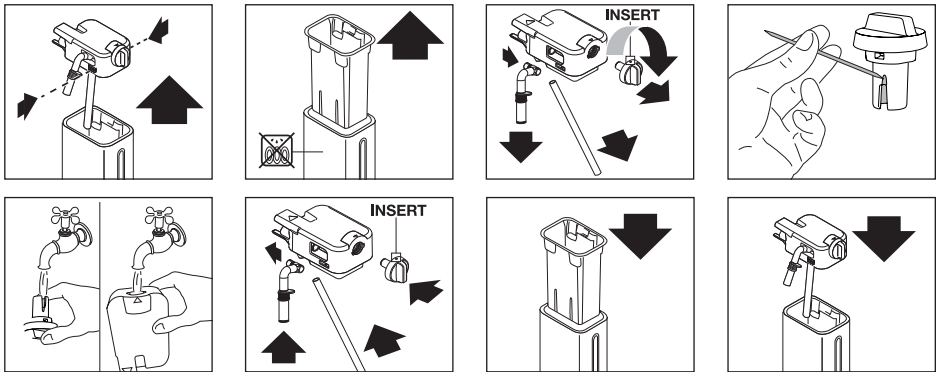

## Clean the appliance's internal circuit

If the appliance is not used for more than 3 or 4 days, we strongly recommend obeying these steps before using it again.

# Maintenance

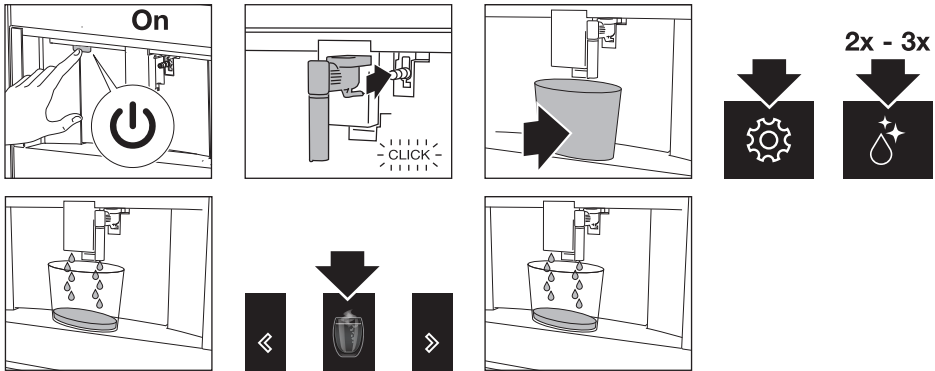

## Clean the coffee grounds container

### NOTE!

- A message to empty the grounds container is displayed 72 hours after the first coffee has been prepared. Do not set the appliance to 'Off' with the main switch. If you do so, the 72 hours cannot be calculated correctly.

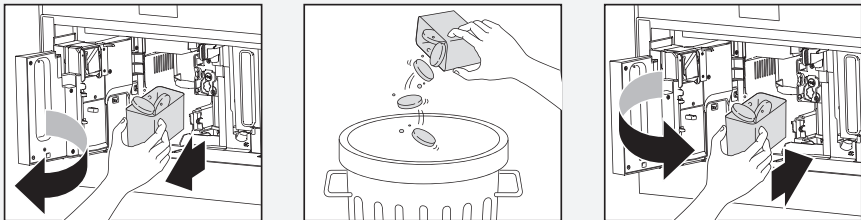

- When removing the drip tray, the grounds container must be emptied, even if it contains few grounds. If this is not done before you make the next coffees, the grounds container may fill up more than expected and clog the appliance.

## Clean the drip tray

### NOTE!

Clean and empty the drip tray before the indicator is above the cup tray. If you do not, water may overflow the edge and damage the appliance, the surface it rests on or the surrounding area.

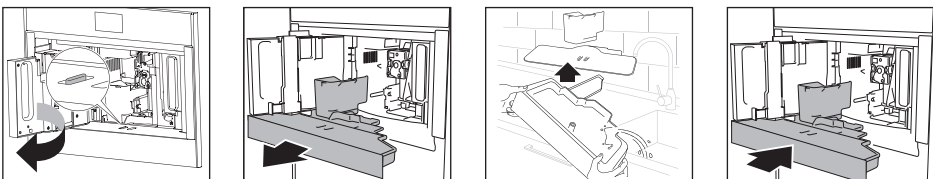

## Clean the inside of the coffee machine

### ⚠ WARNING!

Before cleaning internal parts, set the appliance to 'Standby'. Do not immerse the coffee machine in water.

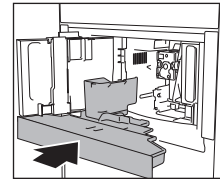
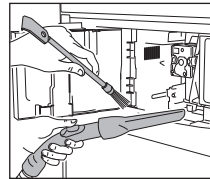
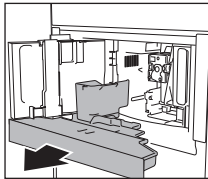
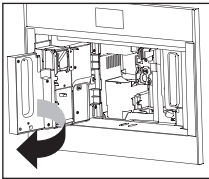

## Clean the water tank

### NOTE!

Clean the water tank with a damp cloth and a little mild washing-up liquid. Rinse thoroughly before filling the tank and putting it back in the appliance.

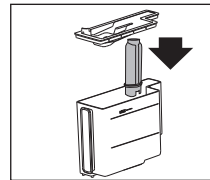
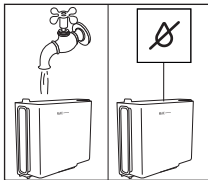
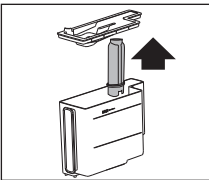

## Clean the coffee spouts

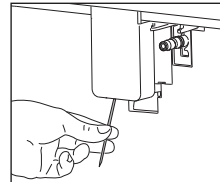
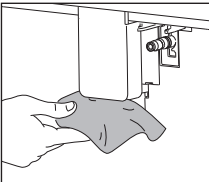

## Clean the pre-ground coffee funnel

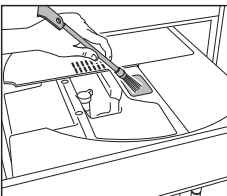

# Maintenance

## Descal the appliance

Descal the appliance when the related message is shown on the display.

- To descale immediately, read and obey the instructions shown on the display.
- To descale the appliance later, touch the escape key.
  - A symbol is shown on the display to remind you that the appliance needs descaling.

### ⚠ WARNING!

Before use, read the instructions and the labelling on the descaler pack. You should use a descaler authorised by the manufacturer only. Using an unsuitable descaler and/or performing descaling incorrectly may result in faults not covered by the manufacturer's warranty.

### ⚠ WARNING!

#### **Danger! Risk of burns.**

Hot water containing acid flows out of the hot water spout. Take care to avoid contact with splashes of this solution.

### NOTE!

- A series of rinses and pauses is performed automatically to remove all the scale residues inside the coffee machine. Empty the container every time after it has collected the rinsing water.
- If a filter was removed previously, the display will show the message when to insert the filter into the housing. If no filter was present, you can skip this step.
- If the descaling cycle is not completed correctly (e.g. no electricity) we recommend repeating the cycle.
- If the water tank has not been filled to the MAX level, at the end of descaling, the appliance requests a third rinse to guarantee that the descaler solution has been completely eliminated from the appliance's internal circuits. Before starting rinsing, remember to empty the drip tray.
- The appliance may request descaling cycles at very short intervals. This is normal due to the appliance's advanced control system.

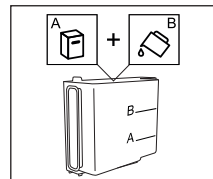
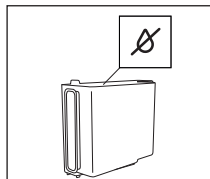
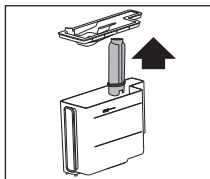
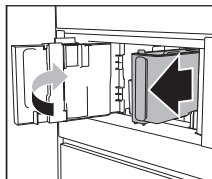

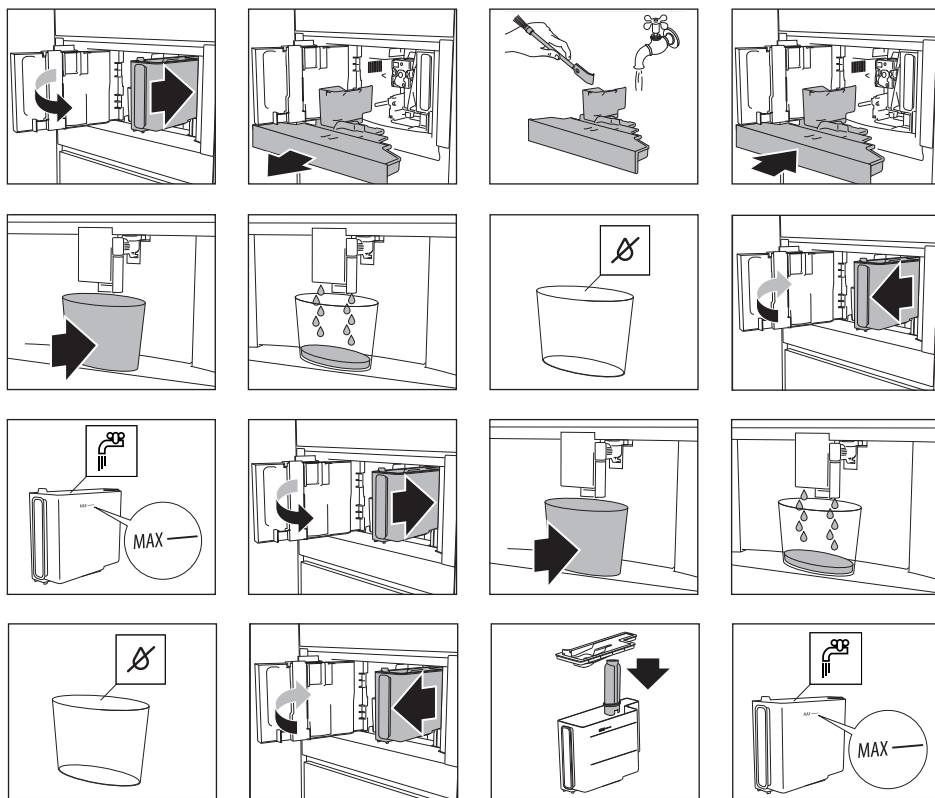

## Set the water hardness

### NOTE!

The appliance is set by default for a hardness level of 4. The appliance can also be programmed according to the hardness of the mains water in the various regions.

The appliance needs to be descaled less often if this hardness level is lower.

Immerse the 'total hardness test' indicator paper (attached to the instructions) in a glass of water for one second.

*After about a minute, red squares can be seen.*

# Maintenance

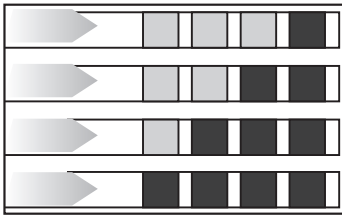

Level 1: soft water

Level 2: moderately hard water

Level 3: hard water

Level 4: very hard water

**1x/2x/3x/4x**



*The appliance is now programmed with the new water hardness setting.*

## Install a water softener filter

### NOTE!

Certain models are fitted with a water softener filter. If this is not the case with your model, you are recommended to purchase one from the service department.

### NOTE!

The filter lasts about two months if the appliance is used normally. If the coffee machine is left unused with the filter installed, it will last a maximum of 3 weeks.

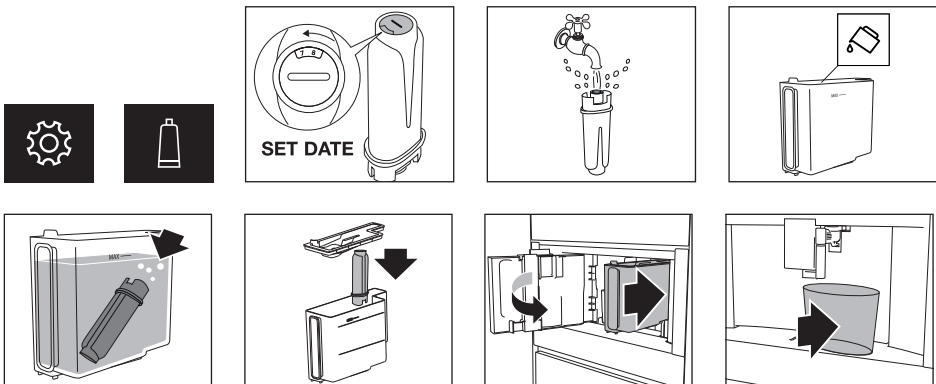

The water filter symbol is shown on the display adjacent to the time. This indicates that the filter has been enabled.

## Replace a water softener filter

Replace the filter when the related message is shown on the display.

- To replace the filter immediately, read and obey the instructions shown on the display.
- To replace the filter later, touch the escape key.
  - A symbol is shown on the display to remind you that the filter needs to be replaced.

### TIP!

Take a look at the pictures in the previous section on how to install the filter.

### NOTE!

After two months (see date indicator) or when the appliance has not been used for 3 weeks, you should replace the filter even if the message has not been displayed yet.

## Remove a water softener filter

If you want to use the appliance without the filter, you must remove it and notify the appliance of its removal.

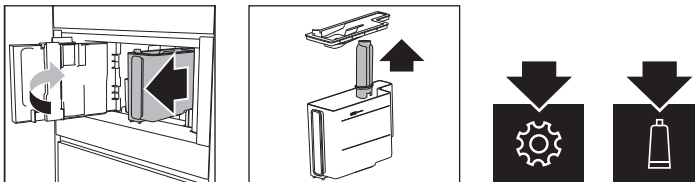

## Clean the brewing unit/infuser once a month

### ⚠ WARNING!

- Do not remove the brewing unit when the appliance is set to 'On'. Set the appliance to 'Standby'. Do not use force to remove the brewing unit.
- Do not use washing-up liquid to clean the brewing unit. It would remove the lubricant applied to the inside of the piston.

# Maintenance

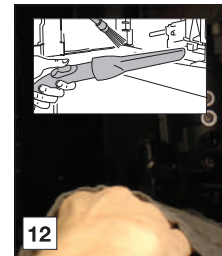
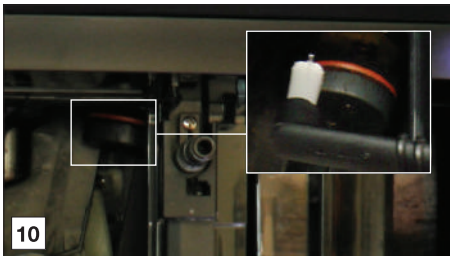
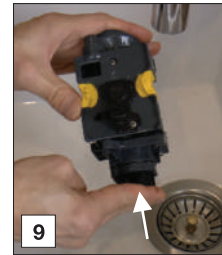
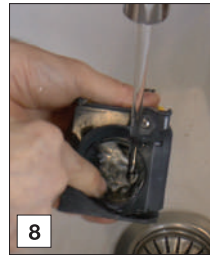
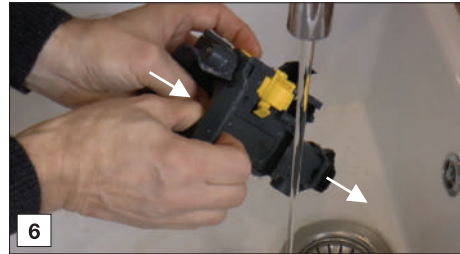
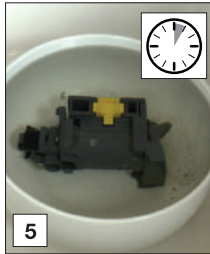
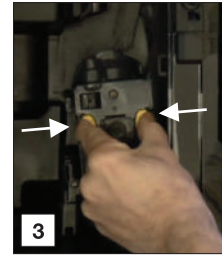
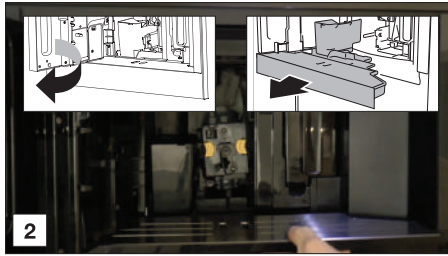
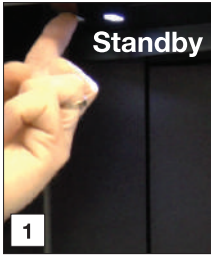

## Clean the brewing unit/infuser twice a year

### ⚠ WARNING!

- Do not remove the brewing unit when the appliance is set to 'On'. Set the appliance to 'Standby'. Do not use force to remove the brewing unit.
- Do not use washing-up liquid to clean the brewing unit. It would remove the lubricant applied to the inside of the piston.

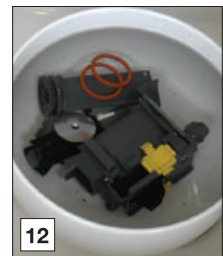
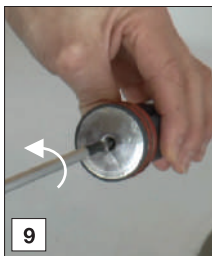
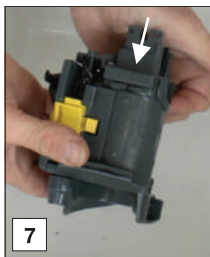
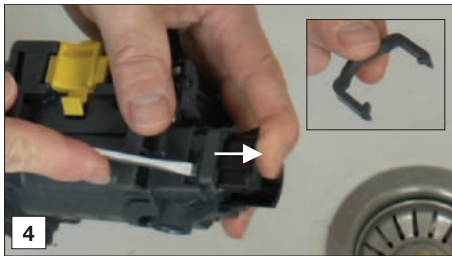
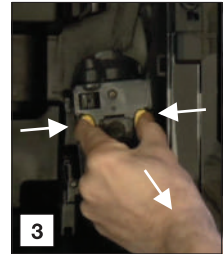
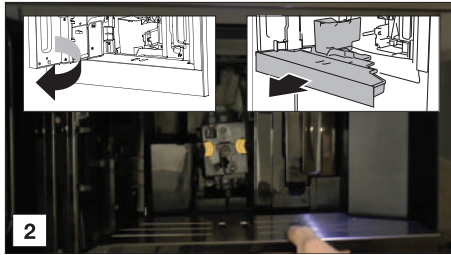
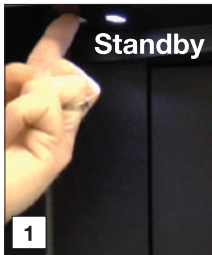

# Maintenance

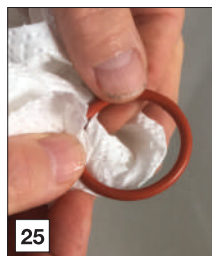
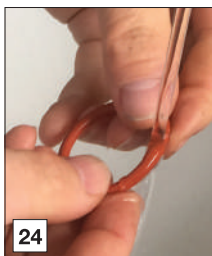
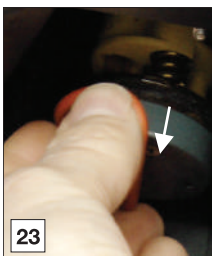
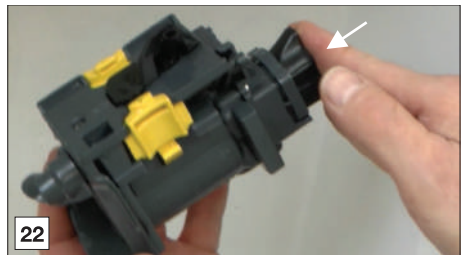
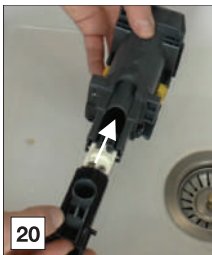

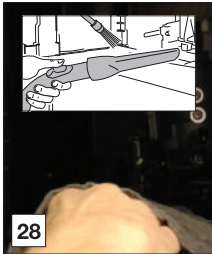

Use the milk cleaner

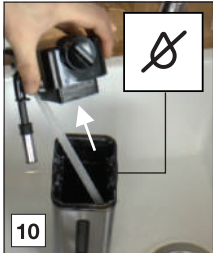
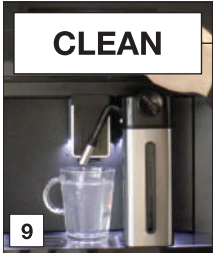
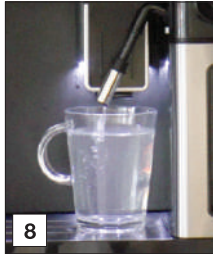
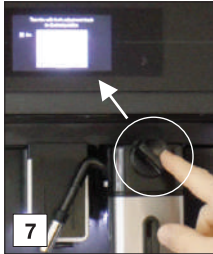

# Maintenance

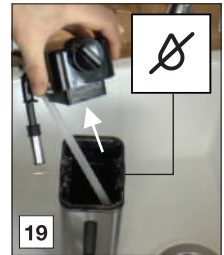
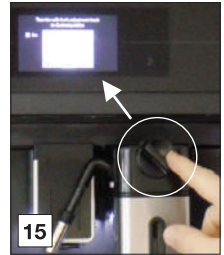





# Troubleshooting

## WARNING!

Read and obey the instructions shown on the display. The display shows information and touch keys to use. Important information is accompanied by an audio signal.

If the given instruction shown on the display or the given remedy in the table below is not the solution to a problem, contact Customer Services.

Problem	Possible cause	Solution
	The inside of the appliance is very dirty.	Clean the inside of the appliance thoroughly.
		Disassemble and clean the brewing unit.
	A reminder that the appliance needs de-scaling and/or the filter must be replaced.	Replace or remove the water filter and/or descale the appliance as soon as possible.
	Reminder to clean the tubes inside the milk container.	Turn the milk froth adjustment knob to 'CLEAN'.
	Reminder to replace the filter.	Replace or remove the water filter.
	Reminder to descale the appliance.	Descal the appliance as soon as possible.
The coffee is not hot.	The cups were not preheated.	Warm the cups by rinsing them with hot water (you can use the hot water function).
	The brewing unit has cooled down because several minutes have elapsed since the last coffee was made.	Before making coffee, use the rinsing function to heat the brewing unit.
	A low coffee temperature is set.	Select a higher coffee temperature.
The coffee is weak or not creamy enough.	The coffee is ground too coarsely.	Adjust the grind level.
	The coffee is not correct.	Use coffee for espresso machines.
The coffee is supplied too slowly or a drop at a time.	The coffee is ground too finely.	Adjust the grind level.
The slices coffee grounds are soft and mushy.	The grind level is not correct.	Adjust the grind level (in the direction of 1).

# Troubleshooting

Table continued from last page

Problem	Possible cause	Solution
Coffee does not come out of one or both of the spouts.	The coffee spouts are blocked.	Clean the coffee spouts.
The appliance does not make coffee.	The appliance has detected impurities in its internal circuits. See the information shown on the display.	Wait for the appliance to be ready for use again and select the required beverage again.
The appliance does not come on.	The appliance is not set to 'On'.	Push the main switch to set the appliance to 'On'.
		Push the On button to set the appliance to 'On'.
The brewing unit cannot be removed.	The appliance has not been set to 'Standby' correctly.	Push the Standby button to set the appliance to 'Standby'.
	The drip tray has not been removed.	Remove the drip tray.
	The brewing unit is not in the correct position.	Close the door and set the appliance to 'On'. The brewing unit automatically returns to the correct position.
The appliance makes a weird sound (not as normal).	The brewing unit and the infuser are dirty.	Clean the infuser and all parts of the brewing unit. Lubricate the O-rings with the lubricating grease.
At the end of descaling, the appliance requests a third rinse.	During the two rinse cycles, the water tank has not been filled to the MAX level.	Obey the instructions shown on the display.
The milk does not come out of the milk spout.	The lid of the milk container is dirty.	Clean all components of the milk container.
The milk contains large bubbles and squirts out of the milk spout or there is little froth.	The milk is not cold enough or is not semi-skimmed or skimmed.	Use skimmed or partially skimmed milk at refrigerator temperature (about 5 °C). If the result is not as you wish, try changing the brand of milk.
	The milk froth adjustment knob is incorrectly adjusted.	Adjust the milk froth adjustment knob.
	The lid of the milk container or the milk froth adjustment knob is dirty.	Clean all components of the milk container.
	The hot water connection nozzle is dirty.	Clean the nozzle.

## Disposal of the appliance and packaging

Sustainable materials have been used during the manufacture of this appliance. This appliance must be disposed of responsibly at the end of its service life. Ask your local authorities for more information about how to do this.

The appliance packaging is recyclable. The following may have been used:

- cardboard;
- polyethylene film (PE);
- CFC-free polystyrene (PS rigid foam).

Dispose of these materials in a responsible manner and in accordance with government regulations.

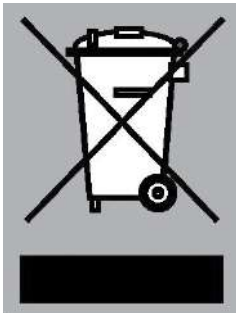

The product has been marked with a crossed-out dustbin symbol to remind you of the obligation to dispose of electrical household appliances separately. This means that the appliance may not be included with normal domestic refuse at the end of its service life. The appliance must be taken to a special municipal centre for separated waste collection or to a dealer providing this service.

A separate collection of household appliances helps to prevent any potential negative impact on the environment and on human health caused by improper disposal. It ensures that the materials of which the appliance is composed can be recovered to obtain significant savings in energy and raw materials.



### Declaration of conformity

We hereby declare that our products satisfy the applicable European directives, orders and regulations, as well as the requirements stated in the referenced standards.

# Installation

## Safety

### WARNING!

If the safety instructions and warnings are not followed, the manufacturer cannot be held responsible for any resulting damage.

- After removing the packaging, make sure the product is complete and undamaged. If in doubt, do not use the appliance and contact a qualified professional.
- Installation must be carried out by a qualified technician and in compliance with current regulations.
- Packing elements (plastic bags, polystyrene etc.) must not be left within reach of children as they may represent a hazard.
- Never install the appliance in environments where the temperature may reach 0 °C or lower (the appliance may be damaged if the water freezes).
- Make sure the mains voltage corresponds to the voltage indicated on the appliance rating plate. Connect the appliance to an efficiently earthed socket. The manufacturer may not be considered liable for possible incidents caused by the failure to adequately earth the mains.
- Make sure the socket used is freely accessible at all times, enabling the appliance to be unplugged when necessary.
- Never touch the plug with damp hands.
- Never pull the power cable as you could damage it.
- This appliance can be installed over a built-in oven if the latter is fitted with a cooling fan.
- Do not use multiple plug adapters or extension leads.
- The power cable on this appliance must not be replaced by the user as this operation requires the use of special tools. If the cable is damaged or requires replacing, contact an authorised service centre only to avoid all risks.
- You should personalise water hardness as soon as possible following the instructions.

- If a stationary appliance is not fitted with a supply cord and a plug, or with other means for disconnection from the supply mains having a contact separation in all poles that provide full disconnection under overvoltage category III conditions, the means for disconnection must be incorporated in the fixed wiring in accordance with the wiring rules. This is also applicable for appliances with a supply cord and plug when the plug is not accessible after installing the appliance. Using an omnipolar switch with a contact separation of at least 3 mm fitted in the fixed wiring will fulfil this requirement.

## Dimensions

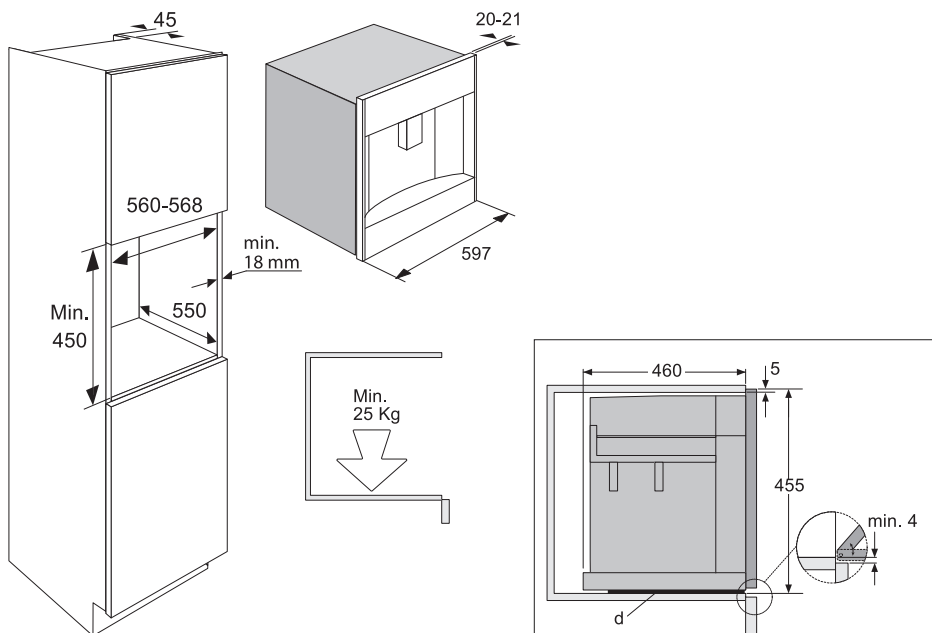

# Installation

## Built-in

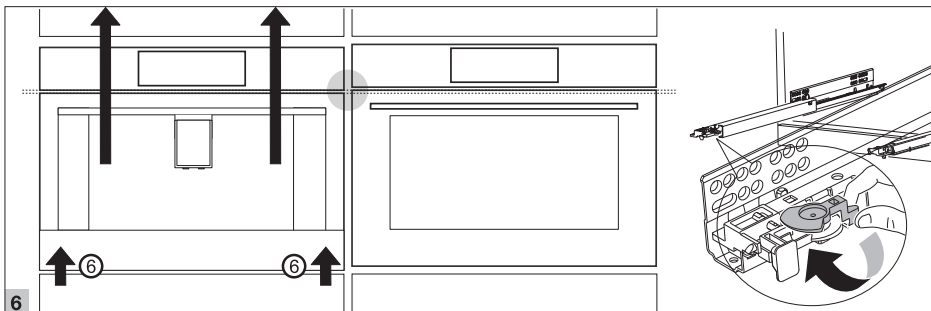
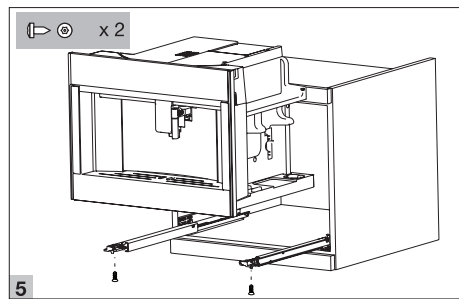
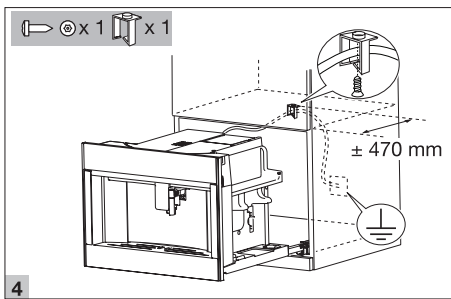
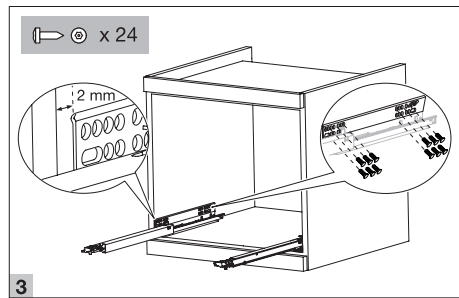
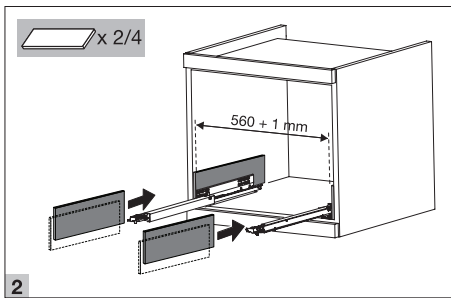
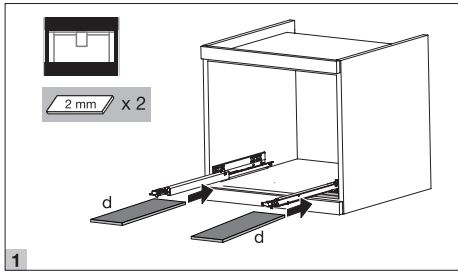

# Installation

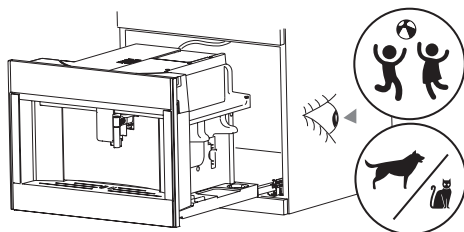
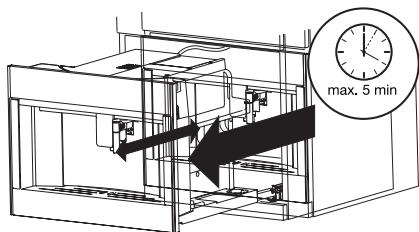



Inspired by Scandinavia

[www.asko.com](http://www.asko.com)



570051-a1



*We reserve the right to make changes.*