



## **User Manual**

---

**VWS820SCB-X**

**VWD820SCB-X**

**VBS820SCB-X**

## Table of Contents

WARNING	.....	3
INSTALLATION	.....	4
STORAGE	.....	6
OPERATION	.....	8
WINE SERVING & DEFROSTING	.....	12
ADJUSTABLE SHELVES	.....	12
DOOR REVERSAL	.....	13
HOW TO REPLACE ACTIVATED CARBON PACK	.....	13
ANTI-TIP BRACKET INSTALLATION INSTRUCTIONS	.....	14
TROUBLESHOOTING	.....	15
TROUBLESHOOTING & DATA	.....	16

### Important Information that may impact your Manufacturer's Warranty

Adherence to the directions for use in this manual is extremely important for health and safety. Failure to strictly adhere to the requirements in this manual may result in personal injury, property damage and affect your ability to make a claim under the Vintec manufacturer's warranty provided with your product. Products must be used, installed and operated in accordance with this manual. You may not be able to claim on the Vintec manufacturer's warranty in the event that your product fault is due to failure to adhere to this manual.

## WARNING

The information in this document is subject to modification without any prior notice. Some models are available in dedicated countries only. VINTEC offers no guarantee for our Wine Cellar and Beverage Centre if it is being used for any purpose other than that for which it was specifically designed. VINTEC cannot be held responsible for any error in this manual.

This appliance is not intended for storing food of any sort. This appliance is not intended for use by persons (including children) with reduced physical, sensory or mental capabilities, or lack of experience and knowledge, unless they have been given supervision or instruction concerning use of the appliance by a person responsible for their safety. Children should be supervised to ensure they do not play with the appliance (AU & NZ).

This appliance can be used by children aged from 8 years and above and persons with reduced physical, sensory or mental capabilities or lack of experience and knowledge if they have been given supervision or instruction concerning use of the appliance in a safe way and understand the hazards involved. Children shall not play with the appliance. Cleaning and user maintenance shall not be made by children without supervision .

This appliance uses flammable refrigerant, please secure the cooling pipe during the delivery process. Position the wine cellar away from direct sunlight and sources of heat (stove, heater, radiator, etc.). Never clean appliance parts with flammable fluids. The fumes can create a fire hazard or explosion. When disposing your appliance, please choose an authorized disposal site. Children should be supervised to ensure that they do not play with the appliance.

### R600A WARNINGS

The following models use small quantity of R600A (iso-butane) flammable refrigerant:  
VWS820SCB-X/VWD820SCB-X/VBS820SCB-X: -35g

For your safety please observe the following recommendations :

- This appliance contains a small quantity of R600A refrigerant which is flammable. Avoid safety hazards by carefully installing, handling, servicing and disposing of this appliance.
- During transportation and installation, ensure that the tubing of the refrigerant circuit is not damaged.
- Avoid using or manipulating sharp objects near the appliances.
- Leaking refrigerant can ignite and may damage the eyes.
- In the event any damage does occur, avoid exposure to open fires and any device which creates a spark. Disconnect the appliance from the mains power.
- Thoroughly ventilate the room in which the appliance is located for several minutes.
- Notify Customer Service for necessary action and advice.

- The room for installing the appliance must be at least 1 cubic metre per 8 grams of refrigerant. The refrigerant quantity contained in this appliance is listed above in grams; it is also noted on the Rating Plate of the appliance.

### It is hazardous for anyone other than an Authorised Service Person to carry out servicing or repairs to this appliance.

- WARNING: Keep ventilation openings in the appliance enclosure or in the built-in structure clear of obstruction.
- WARNING: Do not use mechanical devices or other means to accelerate the defrosting process, other than those recommended by the manufacturer.
- WARNING: Do not damage the refrigerant circuit.
- WARNING: Do not use electrical appliances inside the compartments.
- WARNING: Do not store explosive substances such as aerosol cans with a flammable propellant in this appliance.
- WARNING: This appliance is intended to be used in household and similar applications such as:
  - Staff kitchen areas in shops, offices and other working environments;
  - Farm houses and by clients in hotels, motels and other residential type environments;
  - Bed and breakfast type environments;
  - Catering and similar non-retail applications
- WARNING: Do not use electrical appliances inside the food storage compartments of the appliance, unless they are the type recommended by the manufacturer.
- WARNING: If the power cord is damaged, it must be replaced by the manufacturer, its service agent or similarly qualified persons in order to avoid a hazard.
- WARNING: When positioning the appliance ensure the supply cord is not trapped or damaged.
  - WARNING: Do not locate multiple portable socket-outlets or portable power supplies at the rear of the appliance.
- WARNING: Your appliance is fitted with long life LED lighting. In the unlikely event the LED lights should fail, then the LED lights should be serviced by the manufacturer, its service agent or similarly qualified persons in order to avoid a hazard.
- WARNING: In Queensland Australia, the authorised pers on must hold a Gas Work Authorisation for hydrocarbon refrigerants, before carrying out servicing or repairs which involve the removal of covers. The environment and personal safety must be considered when disposing of this appliance. Please ensure the appliance is taken to a recycle centre for safe recycling. This appliance contains insulation formed with flammable blowing gases and flammable refrigerant. Avoid safety hazards by carefully disposing of this appliance.

**Allow 24 hours before switching on the Wine Cellar and Beverage Centre. During this time we recommend that you leave the door open to clear any residual odours.**  
BEFORE LOADING & PLUGGING IN THE WINE CELLAR AND BEVERAGE CENTRE.

*Important: All models without front venting (air opening) are strictly for free standing only.*

**Recommendations:**

The location you have selected for your Wine Cellar and Beverage Centre should:

- be unencumbered and well ventilated;
- be well away from any heat source and direct sunlight;
- not be too damp (laundry, pantry, bathroom etc.);
- have a flat floor;
- have a standard and reliable electricity supply (standard socket to country standards, linked to the ground). It is NOT recommended to use a multi-socket or extension lead;
- have a surge protector fitted to the electrical outlet;
- away from the microwave oven. Certain microwave ovens do not have wave interference shield. When placed within 1 meter vicinity of the wine cabinet, they may affect the operation of the wine cabinet.

**Notes:**

- VWS820SCB-X/VWD820SCB-X/VBS820SCB-X models are slot-in type as per the drawings in the installation section (page 5).

The Wine Cellar and Beverage Centre should be placed on a level surface in a dry, well -ventilated room (max. 75% relative air humidity). In hot humid climate areas and particularly on hot rainy days, humidity in the ambient air can condense on the cold external surfaces, glass door or door sealing gasket strip. Especially when appliance is set at the coldest temperature setting in a long period of time during high humid days which is a natural phenomenon. During monsoon season or high humidity days, we recommend setting the temperature at warmer or at cellaring temperature mode. Or you can simply wipe off any moisture or water droplets with soft dry cloth. Condensation will disappear when humidity level drops or temperature set to a warmer setting.

The Wine Cellar and Beverage Centre should be placed where declares climate class. If the ambient temperature is above or below this range, the performance of the unit may be affected. Placing your unit in extreme cold or hot conditions may cause interior temperatures to fluctuate. The ideal range of temperature may not be reached. (See Climate Class at the end of this manual).

**Grounding instructions**

The Wine Cellar and Beverage Centre must be grounded in case of an electrical short circuit. Grounding reduces the risk of electrical shock. The Wine Cellar and Beverage Centre is equipped with a power cord having a grounding wire and plug. The Wine Cellar and Beverage Centre plug

must be plugged into a properly affixed and grounded electrical outlet.

**Note:** In locations where there is frequent lightning, it is advisable to use surge protectors.

Improper use of the grounding plug can result in the risk of electric shock. Consult a qualified electrician or service person if the grounding instructions are not completely understood. If the supply cord is damaged, it must be replaced by a qualified person in order to avoid electrical hazard.

**INSTALLATION**

Unpack and remove all of the protection and adhesive strips from the packaging around and inside the Wine Cellar and Beverage Centre. The Wine Cellar and Beverage Centre must be positioned such that the plug is accessible. Release the power cord.

Move your Wine Cellar and Beverage Centre to its final location. The Wine Cellar and Beverage Centre should be installed in a suitable place where the compressor will not be subject to physical contact.

- **WARNING:** Ensure the plug is accessible when the appliance is in position, or a switch is incorporated in fixed wiring according to the wiring rules. (See licensed electrician for further advice).

**Levelling your Wine Cellar and Beverage Centre:** Wine Cellar and Beverage Centre must be leveled BEFORE loading your wines. Your Vintec Wine Cellar and Beverage Centre is equipped with 4 adjustable feet to facilitate easy leveling.

**VINTEC** recommends that you tighten the back feet to the maximum and adjust the front feet to level of the Wine Cellar and Beverage Centre.

**Fixing the Back spacer:**

Compressor run appliances require good ventilation for effective and longer usage. Your Vintec Wine Cellar and Beverage Centre is supplied with a back spacer.

Affix the back spacer at the back of the cellar for air circulation and heat evacuation.

INSTALLATION OF BACK SPACER

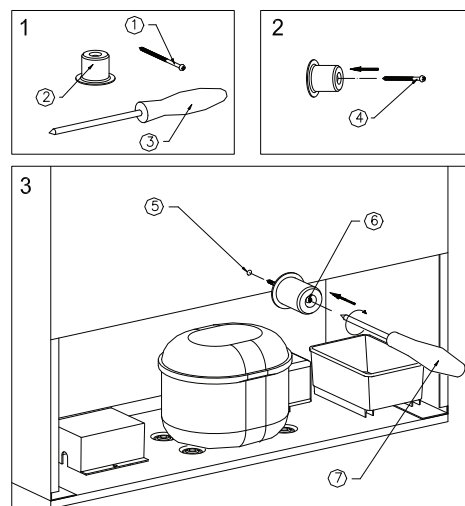

**IMPORTANT - THIS SPACER MUST BE ATTACHED TO THE UNIT BEFORE THE INSTALLATION, FOR VENTILATION PURPOSE. FAILURE TO DO WILL VOID THE WARRANTY !**

**UNDER-BENCH INSTALLATION INSTRUCTIONS**

DIMENSIONS:

VWS820SCB-X/VWD820SCB-X/VBS820SCB-X

Cabinet Height	820-870mm
Cabinet Width	595mm
Total depth	525mm+30mm (Back spacer)

This Vintec Wine Cellar and Beverage Centre is not designed to be fully integrated behind a joinery door. Please note that:

For VWS820SCB-X/VWD820SCB-X/VBS820SCB-X a minimum cut out width of 615mm is required to facilitate installation, removal and servicing.

1. Vintec "Slot-in" Wine Cellar and Beverage Centres are front venting but are not designed to be fully integrated behind a joinery door.
2. Vintec "Slot-in" Wine Cellar and Beverage Centres require 10mm clearance on both sides and 30mm on top, 30mm clearance at the rear (Back spacer is provided), to facilitate installation, removal, servicing and ventilation.
3. Vintec "Slot-in" Wine Cellar and Beverage Centres draw air from the rear and expels it through the metal grid under the door at the front. If a kick board is to be placed in front of the Wine Cellar and Beverage Centre's grid another one must be fitted into the kick board with a minimum air flow allowance of 150cm<sup>2</sup>.
4. Vintec "Slot-in" Wine Cellar and Beverage Centres have a power switch located on the control panel so power point location is not critical.
5. The Wine Cellar and Beverage Centre requires a standard 240 volt/10 amp power point. (Or according to different countries specifications).
6. The power cord is min 1.8m in length and is fixed on the right side at the back when looking from front of cabinet.
7. As with most appliances of today, the Wine Cellar and Beverage Centre has sensitive electronic components which are susceptible to damage through lightning and electricity supply faults. It is therefore advised to use a power surge protector to avoid problems of this nature.

**8. Air vent within the joinery must be provided for Vintec "Slot-in" Wine Cellar and Beverage Centres (Front venting)**

In Hot climate zone, an air vent or grid, with a minimum ventilation size of 200mm x 40mm MUST be cut out at the rear top of the back partitioning or at the top of either side of the partitioning, allowing cool fresh air full access to flow into the 30mm gap located at the rear of the cabinet.

This air vent or grid must not be opened on the same side as other appliances such as ovens or an area that is sealed and without access to fresh cool air. Failing to comply with the above specifications could result in WARRANTY void.

INSTALLATION DRAWINGS FOR front venting under bench Wine Cellars and Beverage Centres: Front View (VWS820SCB-X/VWD820SCB-X /VBS820SCB-X)

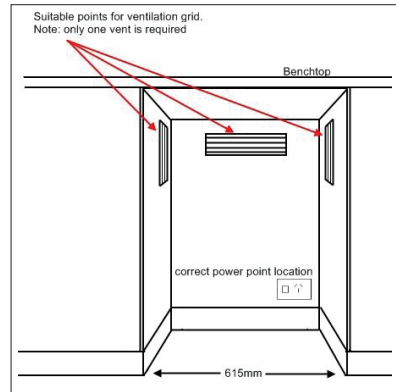

**Cross section**

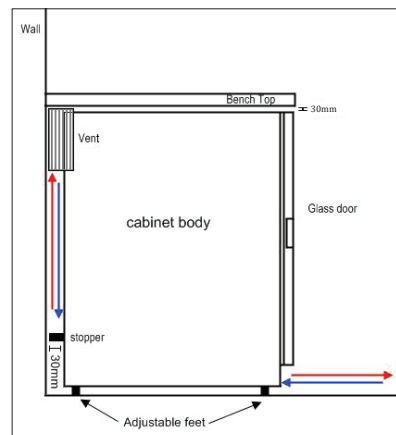

**Dimensional drawings:**

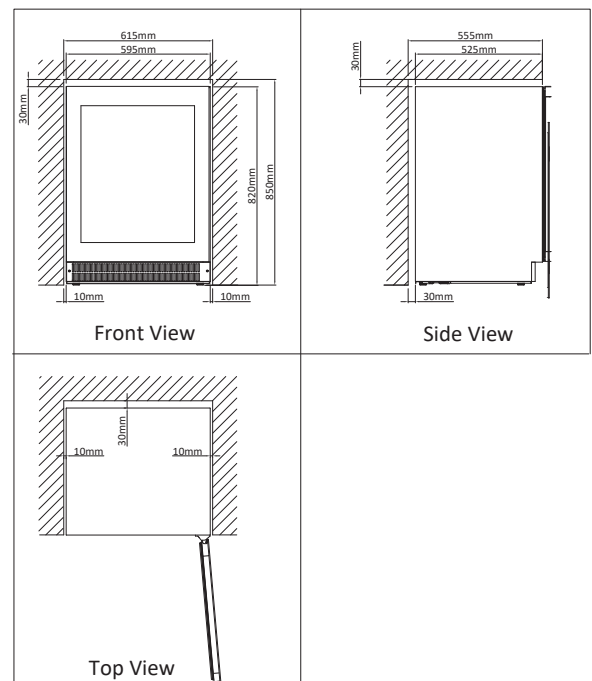

### TURNING ON YOUR WINE CELLAR AND BEVERAGE CENTRE.

Plug in and switch on the cellar by pressing on the power button for a few seconds.

When you use the Wine Cellar and Beverage Centre for the first time (or restart the Wine Cellar and Beverage Centre after having it shut off for a long time), there will be a few degrees variance between the temperature. Once the Wine Cellar and Beverage Centre is running for a few hours everything will stabilise.

### OPERATING NOISES

To reach the desired temperature settings, VINTEC Wine Cellar and Beverage Centres, like all Wine Cellar and may produce the following types of noises. These noises are normal and may occur as follows:

- Gurgling sound - caused by the refrigerant flowing through the appliance's coils.
- Cracking/popping sounds - resulting from the contraction and expansion of the refrigerant gas to produce cold.
- Fan operating sound - to circulate the air within the Wine Cellar and Beverage Centre.

An individual's perception of noise is directly linked to the environment in which the Wine Cellar and Beverage Centre is located, as well the specific type of models. VINTEC Wine Cellar and Beverage Centres are in line with international standards for such appliances. VINTEC will always do its utmost to satisfy its customers but will not retake possession of the goods due to complaints based on normal operating noise occurrences.

### LOADING YOUR WINE CELLAR AND BEVERAGE CENTRE.

You may load your wine bottles in single or double rows while taking note of the following: if you do not have enough bottles to fill your Wine Cellar and Beverage Centre, it is better to distribute the load throughout the Wine Cellar and Beverage Centre so as to avoid all on top or all below type loads.

### Storage diagram

FOR VWS820SCB-X, Total: 41bottles

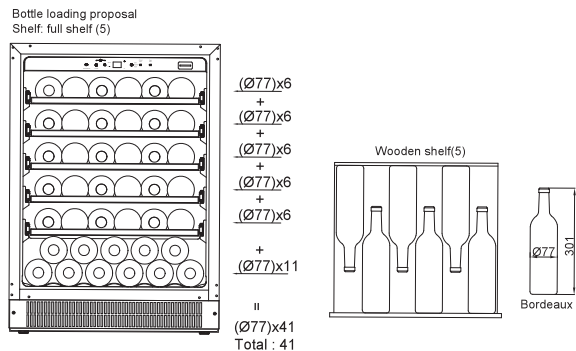

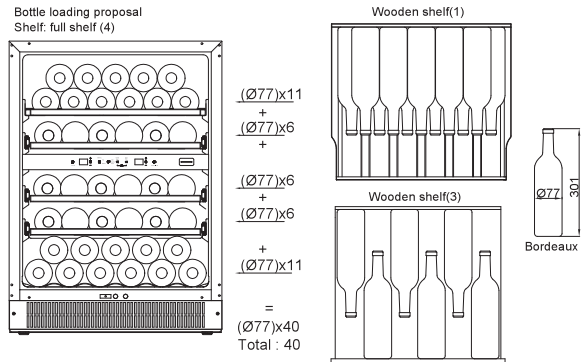

FOR VWD820SCB-X, Total: 40bottles

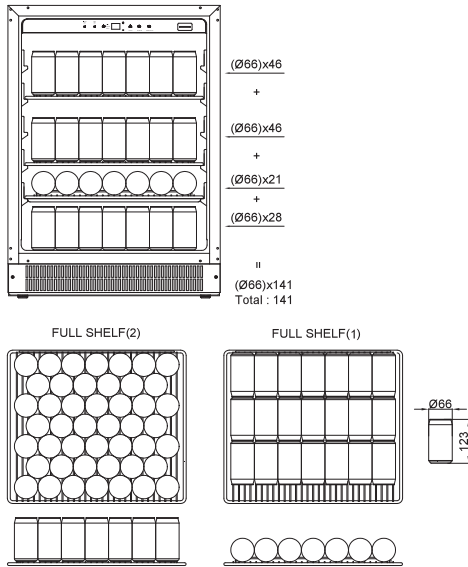

### FOR VBS820SCB-X, Total: 141cans (Max)

Bottle loading proposal#1  
Shelf: full shelf (3)



- Do not remove or relocate adjustable wooden shelves to accommodate larger type of bottles or increase the capacity of the cellar by stacking the bottles up when necessary. (See removing shelves).
- Keep small gap between the walls and the bottles to allow air circulation. Like an underground cellar air circulation is important to prevent mould and for a better homogeneous temperature within the cellar. 
- Do not over load your Wine Cellar and Beverage Centre to facilitate air circulation.
- Do not stack more than 1.5 rows of standard 0.75L bottles per shelves to facilitate air circulation.
- Avoid obstructing the internal fans (Located inside on the back panel of the Wine Cellar and Beverage Centre).
- Do not slide the shelves outwards beyond the fixed position to prevent the bottles from falling.
- Do not pull out more than one loaded shelf at a time as this may cause the Wine Cellar and Beverage Centre to tilt forward.

- Do not cover the wooden shelves with alloy foil or other materials, as it will obstruct air circulation.
- Do not move your Wine Cellar and Beverage Centre while it is loaded with wines. This might distort the body of the Wine Cellar and Beverage Centre and cause back injury.

### TEMPERATURE STABILITY AND WINE STORAGE

Please note that depending on the loading and settings chosen it takes about 24 hours for the Wine Cellar and Beverage Centre to see the temperature stabilising. During this time the LED seems to move erratically in particular for dual zone models. It is normal and this process occurs whenever the setting is modified and/or whenever a large amount of bottles are added to the cellar. Designed to store and mature all wines: red, white and sparkling. These Wine Cellar reproduce the ideal conditions for wine storage, at a constant recommended temperature of 12°C. They can also be set to provide ideal serving temperature for full enjoyment of the wine's qualities. Unless stated by the wine maker on the bottle, VINTEC recommends 7°C for your champagne, 12°C for whites and 18°C for reds. (Refer to Wine Service Temperature recommendation chart). Designed to store wines at the correct temperature for best enjoyment. The upper chamber can hold 17 or 12 bottles, depending on the models, at a temperature of 6°C to 10°C dedicated mainly to white, sparkling wines and champagnes. The lower chamber accommodates 23 bottles depending on the models, mainly for red wines, which could be stored either at room temperature (18°C-20°C) for consumption or at 12°C for a longer time of storage.

### TEMPERATURE SETTINGS

This appliance memorizes and saves its set temperature. In case of a power outage, the unit adjusts to its previous temperature setting when power resumes.

### Factory preset chart



Model	Setting	Temperature divation
VWS820SCB-X	12°C	+/-2.5°C
VBS820SCB-X	6°C	+/-2.5°C
VWD820SCB-X	Upper compartment: 6°C	+/-2.5°C
	Lower compartment: 12°C	+/-2.5°C



It is important to understand that there is a difference between the air temperature inside the Wine Cellar and Beverage Centre and the actual temperature of the wine: You will need to wait approximately 12 hours before noticing the effects of temperature adjustment due to the critical mass within a full Wine Cellar and Beverage Centre.

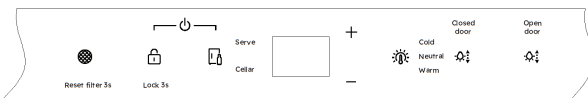

Once the temperature is set, it is strongly advised not to toy with it or adjust frequently. The thermostat will maintain the temperature inside the Wine Cellar and Beverage Centre within a +/- 2.5°C range. But the thermal inertia of the wine and the glass is such that within this temperature range, the actual temperature of the wine will only fluctuate 0.5°C to 1°C.



### Control panel of VWS820SCB-X models







“  ” button (Filter replacement reminder):  
The wine cooler lights up this icon every 6 months to remind you to replace the filter. When the filter is replaced, press “  ” for 3 seconds and the icon light goes off.



“  ” button (child lock):  
The system default control panel is unlocked. Press “  ” for 3 seconds, beep once to activate the child lock. No response when touching the control panel; press “  ” again for 3 seconds, beep once to exit the child lock, the control panel resumes action response.

“  ” button (operation mode switch):  
After power on, the system defaults to "Standard" mode (serving). Press “  ” once, will have a beeping sound, the system switches to Cellar mode (cellaring); press “  ” again and turn the system back to Standard Mode; then cycle... In the cellar mode, the digital tube displays "CE", and the temperature cannot be adjusted. When any temperature button is touched, the digital tube temporarily displays the temperature value (12°C), flashes 5 times, and then returns to display "CE".



“  ” button (light color switch):  
Each time the “  ” button is pressed, a beep sounds and the light color switches between COLD/ NEUTRAL/WARM.



“  ” button (light brightness control in closing state):  
Short press action (to control internal light ON or OFF in the door closing state): lightly press “  ” button once, will have a beeping sound, then internal light will keep on; lightly press “  ” button once, will have a beeping sound, then in the closing state, the internal light remains off. Such a cycle.







Long press action (adjust the brightness level of the internal light in the door closing state): long press “  ” button for 3 seconds, beep once, the brightness of the light begins to gradually dim, about 6 seconds to the darkest. In this process, when the button is released, the brightness level of the light is selected and remembered after closing the door.



“  ” button (light brightness adjustment in open door state):  
Short press action (to control internal light ON or OFF in the door open state): press “  ” button once lightly, BP a sound, then keep interior light off; press “  ” button once lightly, will have a beeping sound, then in the opening state, the internal light will keep on. Such a cycle.

Long press action (adjust the brightness level of the internal light in the door open state): long press “  ” key for 3 seconds, beep once, the brightness of the light begins to gradually dim, about 6 seconds to the darkest. In this process, if the button is released, the brightness level of the light will be selected and remembered after opening the door.

“  ” button (Temperature Up upper button):  
Power on, press “  ” button, BP, the set temperature value rises by 1°C (or 1°F). When the set temperature reaches the upper limit (such as 18°C/ 64 °F), press the button again to sound the "invalid" prompt. The set value flashes 5S, and then the set temperature value is displayed normally.

“  ” button (temperature set down button):  
Power on, every press “  ” button, BP a sound, the set temperature value drops 1°C (or 1°F), when the set temperature reaches the lower limit (such as 6°C/ 41°F), press the button again to sound the "invalid" prompt, the set value flashes 5S, and then display the set temperature value normally.

“  ” + “  ” button combination shutdown: hold the “  ” + “  ” button at the same time for 3 seconds, will have a beeping sound, wine cooler power off. Then hold the “  ” + “  ” button for 3 seconds, will have a beeping sound, wine cooler power on.

- Celsius and Fahrenheit temperature display switching functions:  
Press the “  ” + “  ” button At the same time for 3 seconds can switch between Celsius and Fahrenheit. When the temperature is set to Celsius, the "°C" symbol lights up, and when the temperature is set to Fahrenheit, the "°F" symbol lights up.



-The temperature setting can be adjusted from 6°C to 18°C.

- If you want to know the actual temperature, please press “+” or “-” for 3 seconds, display panel will show actual temperature. After 5 seconds, it will show the set temperature.

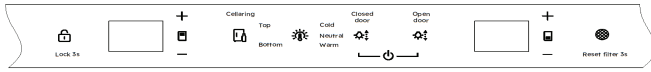
### Control panel of VWD820SCB-X models



“” button (child lock):

The system default control panel is unlocked. Press “” for 3 seconds, beep once to activate the child lock. No response when touching the control panel; press “” again for 3 seconds, beep once to exit the child lock, the control panel resumes action response.



“+” button (Temperature Up upper button):

Power on, press “+” button, BP, the set temperature value rises by 1°C (or 1°F). When the set temperature reaches the upper limit (such as 12°C/54°F or 18°C/64°F), press the button again to sound the "invalid" prompt. The set value flashes 5S, and then the set temperature value is displayed normally.

“-” button (temperature set down button):

Power on, every press “-” button, BP a sound, the set temperature value drops 1°C (or 1°F), when the set temperature reaches the lower limit (such as 6°C/43°F or 10°C/50°F), press the button again to sound the "invalid" prompt, the set value flashes 5S, and then display the set temperature value normally.

“” button (operation mode switch):

After power-on, the system runs in the "standard" mode by default. Every time you press “”, the upper/lower/upper and lower compartment of the system switches to the "wine cellar" mode (cellaring). Press the “” key again, and the system will return to the "standard" mode. then cycle... .

1) Upper compartment (Top) In the cellar mode, the left digital tube displays "CE", and the temperature cannot be adjusted. When touching any temperature button, the left digital tube temporarily displays the temperature value (11°C), blinked for 5 times, and returned to display "CE".

2) Lower compartment (Bottom) In the cellar mode, the right digital tube displays "CE", and the temperature cannot be adjusted. When touching any temperature button, the right digital tube temporarily displays the temperature value (13°C). After blinking for 5 times, the display "CE" is returned.



3) Upper and lower compartment (Top&Bottom) In the cellar mode, the left and right digital tubes display "CE", and the temperature cannot be adjusted. When touching any temperature button, the left digital tube temporarily displays the temperature value (11°C), and the right

digital tube temporarily displays the temperature value (13°C). After blinking for 5 times, the display "CE" is returned.

“” button (light color switch):



Each time the “” button is pressed, a beep sounds and the light color switches between COLD/ NEUTRAL/ WARM.

“” button (light brightness control in closing state):







Short press action (to control internal light ON or OFF in the door closing state): lightly press “” button once, will have a beeping sound, then internal light will keep on; lightly press “” button once, will have a beeping sound, then in the closing state, the internal light remains off. Such a cycle.

Long press action (adjust the brightness level of the internal light in the door closing state): long press “” button for 3 seconds, beep once, the brightness of the light begins to gradually dim, about 6 seconds to the darkest. In this process, when the button is released, the brightness level of the light is selected and remembered after closing the door.

“” button (light brightness adjustment in open door state):

Short press action (to control internal light ON or OFF in the door open state): press “” button once lightly, BP a sound, then keep interior light off; press “” button once lightly, will have a beeping sound, then in the opening state, the internal light will keep on. Such a cycle.

Long press action (adjust the brightness level of the internal light in the door open state): long press “” key for 3 seconds, beep once, the brightness of the light begins to gradually dim, about 6 seconds to the darkest. In this process, if the button is released, the brightness level of the light will be selected and remembered after opening the door.

“” + “” button combination shutdown: hold the “” + “” button at the same time for 3 seconds, will have a beeping sound, wine cooler power off. Then hold the “” + “” button for 3, will have a beeping sound, wine cooler power on.

“” button (Filter replacement reminder):

The wine cooler lights up this icon every 6 months to remind you to replace the filter. When the filter is replaced, press “” for 3 seconds and the icon light goes off.

- Celsius and Fahrenheit temperature display switching functions:

Press the “+” + “-” button at the same time for 3 seconds can switch between Celsius and Fahrenheit.

## OPERATION

When the temperature is set to Celsius, the "°C" symbol lights up, and when the temperature is set to Fahrenheit, the "°F" symbol lights up.

- The temperature setting is range as below:

Upper compartment: 6-12°C

Lower compartment: 10-18°C

- If you want to know the actual temperature, please press " + " or " - " for 3 seconds, display panel will show actual temperature. After 5 seconds, it will show the set temperature.

### Statements for User Instruction Manual for Dual-Zone temperature settings;

Temperature Ranges and Settings and Understanding Your Dual-Zone Wine Fridge.

To ensure optimal storage conditions for your wine collection, your dual-zone wine fridge allows you to set each zone to specific temperature ranges:



- Top Zone: 6-12°C (43-54°F)

- Bottom Zone: 10-18°C (50-64°F)

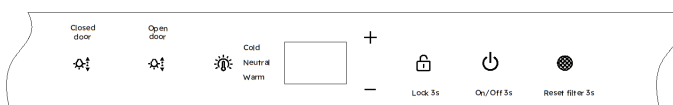

These ranges are designed to provide the ideal environment for different types of wines. The top zone is perfect for sparkling and white wines, which benefit from cooler temperatures, while the bottom zone is tailored for red wines, which require slightly warmer storage.

### Control panel of VBS820SCB-X models





"  " button (light brightness control in closing state): Short press action (to control internal light ON or OFF in the door closing state): lightly press "  " button once, will have a beeping sound, then internal light will keep on; lightly press "  " button once, will have a beeping sound, then in the closing state, the internal light remains off. Such a cycle.

Long press action (adjust the brightness level of the internal light in the door closing state): long press "  " button for 3 seconds, beep once, the brightness of the light begins to gradually dim, about 6 seconds to the darkest. In this process, when the button is released, the brightness level of the light is selected and remembered after closing the door.



"  " button (light brightness adjustment in open door state): Short press action (to control internal light ON or OFF in the door open state): press "  " button once lightly, BP a sound, then keep interior light off; press "  " button once lightly, will have a beeping sound, then in the opening state, the internal light will keep on. Such a cycle.



Long press action (adjust the brightness level of the internal light in the door open state): long press "  " key for 3 seconds, beep once, the brightness of the light begins to gradually dim, about 6 seconds to the darkest. In this process, if the button is released, the brightness level of the light will be selected and remembered after opening the door.

"  " button (light color switch): Each time the "  " button is pressed, a beep sounds and the light color switches between COLD/ NEUTRAL/ WARM.

" + " button (Temperature Up upper button): Power on, press " + " button, BP, the set temperature value rises by 1 °C (or 1 °F). When the set temperature reaches the upper limit (such as 10 °C / 50 °F ), press the button again to sound the "invalid" prompt. The set value flashes 5S, and then the set temperature value is displayed normally.

" - " button (temperature set down button): Power on, every press " - " button, BP a sound, the set temperature value drops 1°C (or 1 °F), when the set temperature reaches the lower limit (such as 2°C/ 36 °F), press the button again to sound the "invalid" prompt, the set value flashes 5S, and then display the set temperature value normally.

"  " button (child lock): The system default control panel is unlocked. Press "  " for 3 seconds, beep once to activate the child lock. No response when touching the control panel; press "  " again for 3 seconds, beep once to exit the child lock, the control panel resumes action response.

"  " Button: hold the "  " button for 3 seconds, will have a beeping sound, wine cooler power off. Then hold the "  " button for 3 seconds, will have a beeping sound, wine cooler power on.

"  " button (Filter replacement reminder): The wine cooler lights up this icon every 6 months to remind you to replace the filter. When the filter is replaced, press "  " for 3 seconds and the icon light goes off.

- Celsius and Fahrenheit temperature display switching functions: Press the " + " + " - " button At the same time for 3 seconds can switch between Celsius and Fahrenheit. When the temperature is set to Celsius, the "°C" symbol lights up, and when the temperature is set to Fahrenheit, the "°F" symbol lights up. -The temperature setting can be adjusted from 2°C to 10°C.

- If you want to know the actual temperature, please press “ + ” or “ - ” for 3 seconds, display panel will show actual temperature. After 5 seconds, it will show the set temperature.

### Exclusion of Specific Close Temperature Set Points

#### Section: Temperature Settings Guidelines

In order to maintain the highest quality of wine storage and to maximize the benefits of the dual-zone feature, certain close temperature set points are not available for selection. Specifically, the following combinations of Top Zone and Bottom Zone temperature set points are excluded:

12°C & 10°C (54°F & 50°F)

12°C & 11°C (54°F & 52°F)

11°C & 10°C (52°F & 50°F)

This exclusion helps to ensure that your wines are stored at their optimal temperatures and that the distinct advantages of a dual-zone fridge are fully realized.

### Benefits of Optimal Temperature Differentiation Why We Exclude Certain Temperature Combinations

Our dual-zone wine cellar is designed to offer precise temperature control to suit the diverse needs of your wine collection. By excluding the close temperature set points, we:

**1.Enhance Wine Quality:** Different types of wine have specific temperature requirements for ideal storage. By maintaining distinct temperature zones, we ensure that each type of wine can age and be enjoyed at its best.

#### Example:

–Sparkling Wines: Sparkling wines, such as Champagne, are best stored at cooler temperatures around 6-8°C. This helps preserve their carbonation and delicate flavors. If the temperature is set too high (e.g., 10-12°C), it can affect the effervescence and freshness.

–Red Wines: Red wines, such as Cabernet Sauvignon or Merlot, require storage temperatures between 12-18°C to develop their full-bodied flavors and complex aromas. If stored too cold (e.g., at 10°C), the aging process slows down, and the wine may not reach its optimal taste profile.

By ensuring a clear temperature difference between the zones, you can store sparkling wines in the top zone at 6-8°C and red wines in the bottom zone at 12-18°C, thus preserving the quality and character of each type of wine.

**2.Simplify Temperature Management:** Clear differentiation between the zones simplifies the management of your wine collection, reducing the risk of accidental suboptimal storage.

#### Example:

–White and Red Wines: White wines, such as Sauvignon Blanc, are best stored at 8-12°C, while red wines like Pinot Noir prefer 12-18°C. If the temperature settings are too close (e.g., 12°C and 11°C), it becomes challenging to

manage and remember which wines are stored where.

This can lead to accidental storage of wines at non-optimal temperatures, affecting their quality. –User Error Prevention: By preventing close temperature settings, users are less likely to mistakenly set both zones to similar temperatures, which can negate the benefits of having a dual-zone fridge. Clear and distinct settings help users easily organize their wines and ensure each type is stored correctly. **3.Optimize Energy Efficiency:** Maintaining distinct temperature ranges for each zone allows the fridge to operate more efficiently, ensuring consistent performance and longevity.

#### Example:

–**Energy Consumption:** When the temperature difference between zones is too small (e.g., 12°C & 11°C), the fridge’s compressor has to work harder to maintain these slight differences, leading to increased energy consumption and wear on the appliance. By setting more distinct temperature ranges, the fridge operates more efficiently, reducing energy use and extending the lifespan of the compressor.

–**Consistent Cooling:** A larger temperature difference between zones allows the fridge to maintain each zone’s temperature more consistently. This consistency is crucial for the long-term storage of wines, ensuring they are kept at their optimal temperature without fluctuations that could affect their aging process.

### Practical Tips for Using Your Wine Fridge for Dual zone temperatures

#### 1.Top Zone: 6-12°C (43-54°F):

- Ideal for sparkling wines and champagnes (6-8°C).
- Perfect for most white wines (8-12°C).
- Ideal for lighter red wines like Pinot Noir and Beaujolais, which can benefit from the lower end of the red wine storage temperature spectrum (12°C).

#### 2.Bottom Zone: 10-18°C (50-64°F):

- Best for red wines (10-18°C).
- Suitable for some fuller-bodied white wines if preferred closer to 12°C.

By following these guidelines of temperature chart and utilizing the dual-zone feature effectively, you can ensure that every bottle in your collection is stored under the best possible conditions, preserving its flavor and quality for your enjoyment.

### WINE SERVING TEMPERATURE CHART

All wines mature at the same temperature, which is a constant temperature set between 12°C to 14°C.

The below chart is an indicative temperature chart to indicate the best temperature for drinking purposes.

Champagne NV, Sparkling, Spumante,	6°C
Dry White Semillon, Sauvignon Blanc,	8°C
Champagne Vintage,	10°C
Dry White Chardonnay,	10°C
Dry White Gewürztraminer, Riesling, Pinot grigio,	10°C
Sweet White Sauternes, Barsac, Montbazillac, Ice Wine, Late Harvest ,	10°C
Beaujolais,	13°C
Sweet White Vintage: Sauternes,	14°C
White Vintage Chardonnay ,	14°C
Red Pinot Noir,	16°C
Red Grenache, Syrah ,	16°C
Red Vintage Pinot Noir,	18°C
Cabernet & Merlot: French, Australian, New Zealand,	18°C
Chilean, Italian, Spanish, Californian, Argentinean,	18°C
Vintage Bordeaux .	18°C

### IMPORTANT INFORMATION ABOUT TEMPERATURE

Your VINTEC Wine Cellar and Beverage Centre has been designed to guarantee optimum conditions for storing and/or serving your wines.

Fine wines require long and gentle developments and need specific conditions in which to reach their full potential.

All wines mature at the same temperature, which is a constant temperature set between 12°C to 14°C. Only the temperature of degustation (wine appreciation) varies according to the type of wines (see Wine Serving Temperature Chart above). This being said and as it is for natural cellars used by wine producers for long periods of storage, it is not the exact temperature that is important, but its consistency. In other words, as long as the temperature of your Wine Cellar and Beverage Centre is constant (between 12°C to 14°C) your wines will be stored in perfect conditions.

Not all wines will improve over the years. Some should be consumed at an early stage (2 to 3 years) while others have tremendous ageing capability (50 and over). All wines have a peak in maturity. Do check with your wine merchant to get the relevant information

### DEFROSTING/CONDENSATION/ HYGROMETRY/ VENTILATION

Your Wine Cellar and Beverage Centre is designed with Auto-cycle defrost system. During Off-cycle the refrigerated surfaces of the Wine Cellar and Beverage Centre defrost automatically. Defrost water from the Wine Cellar and Beverage Centre storage compartment drains automatically and part of it goes into a drainage container, which is located at the back of the Wine Cellar and Beverage Centre next to the compressor. The heat is transferred from the compressor and evaporates any on that has collected in the pan. Part of the remaining water is collected within the Wine Cellar and Beverage Centre for humidity purposes.

This system enables the creation of the correct humidity level inside your Wine Cellar and Beverage Centre required by the natural cork to maintain a long lasting seal.

Notes: The water collected by condensation, is therefore recycled.

All units are equipped with a double glazed glass door that has a LOW-E layer to minimise condensation on the glass door.

The Wine Cellar and Beverage Centre is not totally sealed; Some fresh air is allowed through the drainpipe.

Air is circulated through the cellar by means of a fan/fans and the hollow shelves.

Notes: During the refrigerating cycle, heat is given off which disperses through the external surfaces of the Wine Cellar and Beverage Centre. Avoid touching the surfaces during those cycles.

### ADJUSTABLE WOODEN SHELVES:

#### ADJUSTING/REMOVING THE SHELVES

- For easy access to the storage content, you must pull the shelves approximately 1/3 of its depth out of the rail compartment. These wine cabinets, however, are designed with a notch on each side of the shelf tracks to prevent bottles from falling.

- To prevent damaging the door gasket, make sure to have the door all the way opened when pulling shelves out of the rail compartment.

- When removing any of these shelves out of the rail compartment: to fit or remove the shelf, tilt the shelf as per the diagram and simply pull out, or push in the shelf until it sits on the support brackets securely.

### VBS820SCB-X models

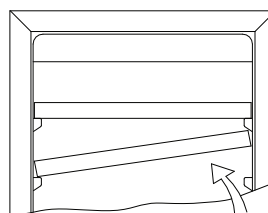

### VWS820SCB-X /VWD820SCB-X models

- To prevent damaging the door gasket, make sure to have the door all the way opened when pulling shelves out of the rail compartment.

- To Remove Shelves:

1. Fully extend the shelf you wish to remove(Fig. A)
2. Lift the front of the shelf up (Fig. A)
3. Holding the shelf track, push the shelf in, then up to release from the rear dampers(Fig. B)

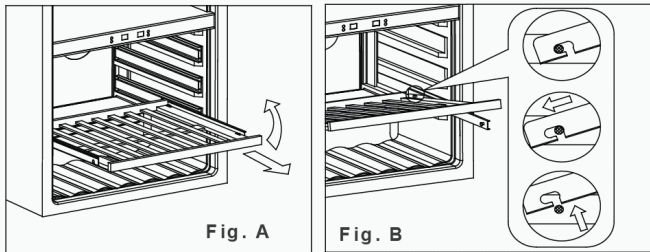

### REVERSIBILITY OF THE DOOR

**WARNING:** To avoid accidents during the process of changing the door, we recommend that you get assistance. The glass door is heavy and may cause injury if dropped.

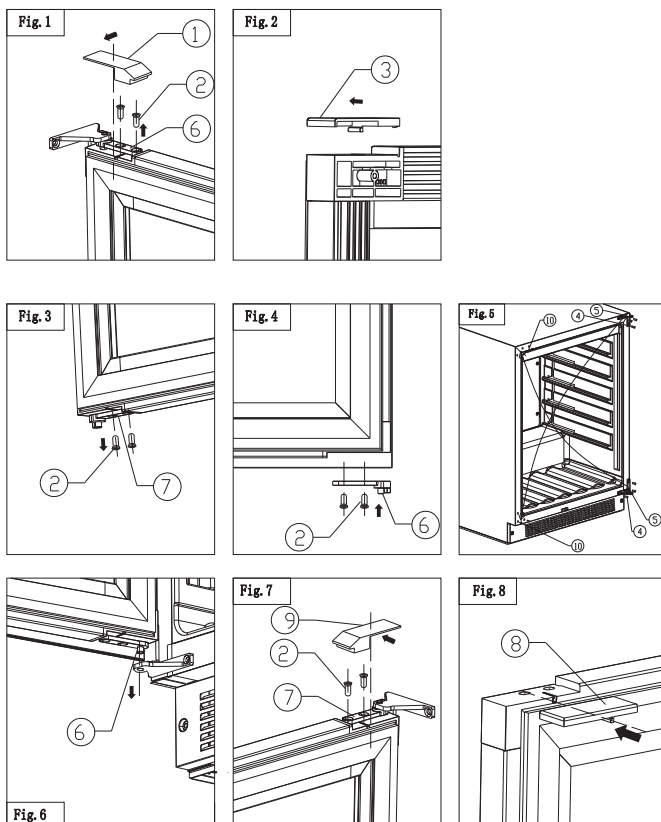

- ① Right upper door hinge decorative cover
- ② Limiting screws
- ③ Left upper corner decorative cover
- ④ Upper and lower door hinge screws
- ⑤ upper and lower door hinges
- ⑥ right upper limit parts
- ⑦ lower right limit parts
- ⑧ right upper corner decorative cover
- ⑨ Left upper hinge decorative cover
- ⑩ upper and lower decorative nails

1) Open the door, push out the right door hinge decorative cover (1) and the left upper corner decorative cover (3) completely according to the arrow direction, and take it away (Fig.1.2);

2) Disassemble the 2 screws (2) (Fig.1) of the right upper limit (6), move the door body outward and remove it, and then remove the right upper limit (6) Installed in the lower left corner of the door body (Fig.4);

3) disassemble 2 screws (2) (Fig.3) of the right lower limiter (7), remove the right lower limiter (7) and set aside;

4) take out the upper and lower decorative nails (10), disassemble 6 upper and lower door hinge screws (4), and remove the upper and lower door hinges (5), after the reversal, they are respectively installed on the left, as shown by the arrow in the figure (Fig.5);

5) first align the spacing part shaft core (6) at the bottom of the door body with the door hinge shaft mandrel hole, and install it on the left door hinge (Fig.6);

6) Install the lower right limiting piece (7) into the mandrel hole of the upper hinge, then push the door to align with the screw hole of the limiting piece (7), tighten it with screws (2), and install the door (Fig.7);

7) Take out the left door hinge decorative cover (9) and the right upper door corner decorative cover (8) from the accessory bag, align the decorative cover with the groove on the door, and push the door hinge cover in the direction of the arrow and install it (Fig.7.8).

Note: Changing the door requires the cooperation of two people.

### How to replace activated carbon pack

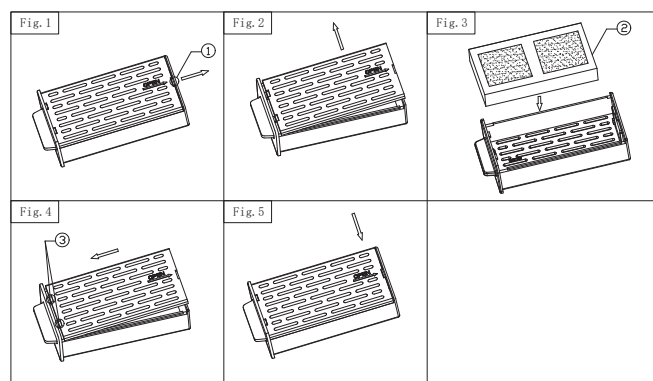

1. Pull back the back clip of the box with your fingernail first, so that the clip is free from the slot of the lid, and then the lid can be removed (Fig.1.2).
2. Then take out the activated carbon pack ② from the manual bag, tear off the sealed bag, and put it into the activated carbon box (Fig.3).
3. Push the card slot at the front of the cover to the card slot (4), and press down the back of the cover so that the card slot is inserted into the card slot (Fig.5).

Then reset filter reminder light on your wine cellar cabinet's UI control panel.

You can purchase a new air filter in this website : [www.shop.vintecclub.com](http://www.shop.vintecclub.com)

**Anti-Tip Bracket Installation Instructions**

**Tools You Will Need**

FOR YOUR SAFETY: While performing installation described in this section, gloves, safety glasses, or goggles should be worn.

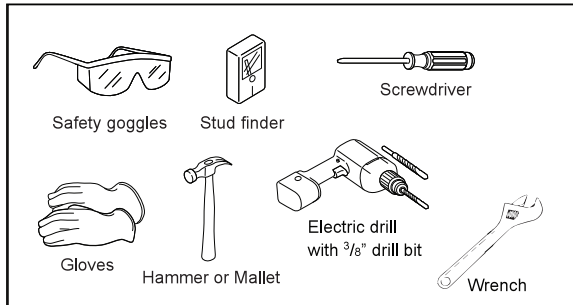

**Installing the Anti-Tip Bracket**

**WARNING:**

This appliance may tip when shelves are extended, causing damage or injury. If this appliance is used in a FREE STANDING application, the anti-tip bracket must be installed following these instructions!

**Anti-Tip bracket parts list:**

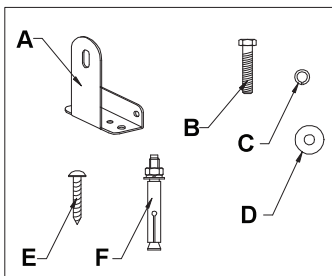

- A: Anti-tip bracket (1pcs)
  - B: Hexagon bolt (1pcs) size (6mmx 20mm) (1/4"x4/5")
  - C: Lock washer (1pcs) size (6)
  - D: Flat washer (1pcs) size (6)
  - E: Screw (2pcs) size (ST4x35)
  - F: Expansion screw (1pcs) size (6mmx60mm) (1/4"x2.4")
- Secure the bracket with the screws provided.

**Anti-tip bracket installation**

The bracket can be installed at the left bottom OR right bottom of the back of the unit.

You can choose which side is convenient for you.

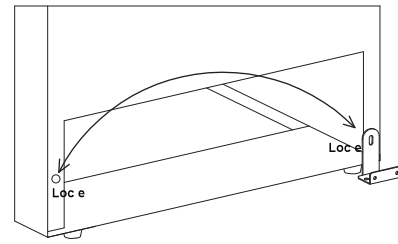

**Anti-tip bracket mounting hole instruction:**

- Location a: Fixed mounting hole for unit
- Location b: Fixed mounting holes for Drywall
- Location c: Fixed mounting holes for Wood floor
- Location d: Fixed mounting holes for Concrete floor
- Location e: Mounting hole on the back unit

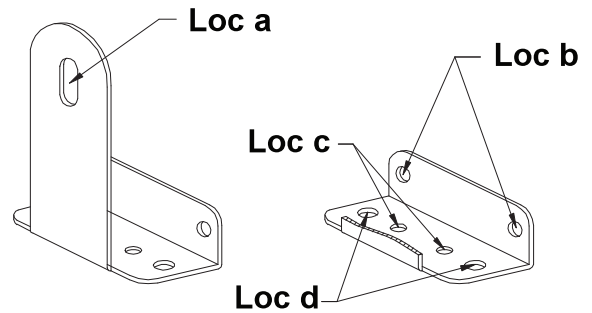

**IMPORTANT:** Determine the final location of the appliance before attempting to install the bracket. You will need to choose one of the three installation methods below.

**DRYWALL installation:**

1. After you have chosen the installation location, place the bracket on the floor with Loc b against the wall, use Screw (E)(2pcs) to secure the bracket to the wall. Ensure at least one screw is secured into a stud.
2. Move the unit to align Loc e to bracket Loc a, secure with the bolt (B), lock washer (C) and flat washer (D).

NOTE: The screws MUST enter into a wood stud. If the wall contains metal studs or similar materials, then the floor installation must be used.

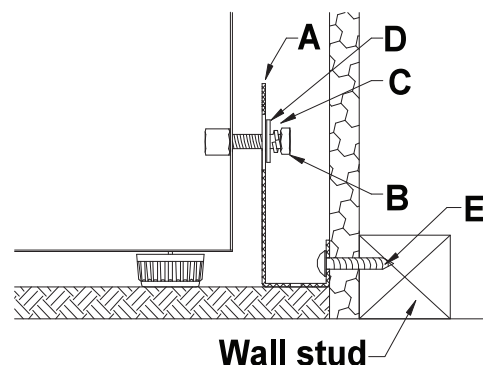

### WOOD FLOOR installation:

1. After you have chosen the installation location, place the bracket on the wood floor, use: Screw (E) (2pcs) align Loc c and secure the bracket into wood floor.
2. Move the unit to align Loc e to bracket Loc a, secure with the bolt(B),lock washer (C) and flat washer (D).

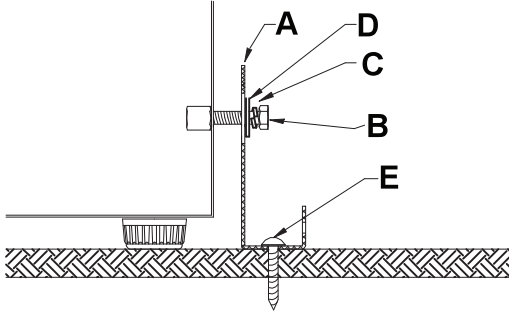

### CONCRETE FLOOR installation:

1. After you have chosen the installation location, choose any hole of Loc d to secure the bracket into the concrete floor.
2. Using a concrete bit, drill 8mm (3/8") pilot hole 45-55mm (1.7"-2") deep.
3. Remove the nut, spring washer and washer of the expansion screw.
4. Carefully tap the expansion screw into the concrete, using a hammer or mallet,
5. Align Loc d and secure the nut, spring washer, washer tightly back on the expansion screw and fix on the concrete floor.
6. Move the unit to align Loc e to bracket Loc a, secure with the bolt(B),lock washer (C) and flat washer (D).

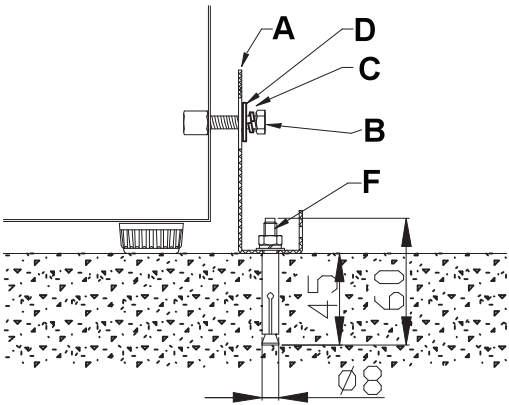

### ATTENTION:

Check the bracket : After installing the bracket,try using light force to tip the unit. If the unit does not tip then the bracket mounted securely.  
If the unit does tip, the bracket **MUST** be reinstalled following these instructions.

### OPERATION ANOMALIES

Ensure that there is power to the electrical supply plug by connecting another electrical appliance to it. Check fuse, if any. Make sure that the door is closed properly.

If your Wine Cellar and Beverage Centre appears to be malfunctioning, unplug it and contact your VINTEC's after sales service. Any intervention on the cold circuit should be performed by a refrigeration technician who should carry out an inspection of the circuit sealing system. Similarly, any intervention on the electrical circuit should be performed by a qualified electrician.

Notes : Any intervention performed by a non- authorized technician by Vintec will lead to the warranty being considered as null and void.

### POWER FAILURES

This appliance memorizes and saves its set temperature. In case of a power outage, the unit adjusts to its previous temperature setting when power resumes.

To avoid sudden change of temperature while the power is off, you should avoid opening the door. For longer periods of power failure, do take steps to protect your wine.

Irrespective of the cause, if you notice either abnormal temperature or humidity levels inside your Wine Cellar and Beverage Centre, be reassured that only long and frequent exposure to these abnormal conditions can cause a detrimental effect on your wines.

### TROUBLESHOOTING GUIDE

Common problems may easily be solved, saving you the cost of a possible service call.  
Please read carefully the instruction manual and refer to the troubleshooting guide chart.

PROBLEM	POSSIBLE CAUSE
Wine Cellar and Beverage Centre does not operate.	Not plugged in. The appliance is turned off. The circuit breaker tripped or the fuse is broken.
Wine Cellar and Beverage Centre is not cold enough.	Check the temperature control setting. External environment may require a higher setting. The door is opened too often. The door is not closed completely. The door gasket does not seal properly.
Turns on and off frequently.	The room temperature is higher than normal. A large amount of contents has been added to the Wine Cellar and Beverage Centre. The door is opened too often. The door is not closed completely. The temperature control is not set correctly. The door gasket does not seal properly.
The light does not work.	Not plugged in. The circuit breaker tripped or a blown fuse. The bulb is out of order. The light button is "OFF".
Vibrations.	Check to assure that the Wine Cellar and Beverage Centre is level.

The Wine Cellar and Beverage Centre seems to make too much noise.	A Gurgling noise may come from the low side of the refrigerant system, which is normal as each cycle ends in your Wine Cellar and Beverage Centre. Contraction and expansion of the inside walls may cause popping and crackling noises. The Wine Cellar and Beverage Centre is not level.
The door will not close properly.	The Wine Cellar and Beverage Centre is not level. The door was reversed and not properly installed. The gasket is faulty. (Magnet or rubber is spoiled). The shelves are out of position.
Condensation or droplets on exterior surfaces, glass door, sealing gasket strip. This is a natural phenomenon	Wipe off any condensation or droplets with soft dry cloth. Place appliance in a lower humidity area. Try adjusting temperature to be slightly warmer above the coldest temperature setting or wait until humidity back to at lower levels (recommended place appliance at max or lower than 75% relative air humidity area)

Technical Data:

Models	VWS820SCB-X	VVD820SCB-X	VBS820SCB-X
Capacity	750ml bordeaux Bottles 375ml Beer Bottles	41 -	17 upper/23 lower - 141
Gas charge(g)	35g	35g	35g
Net capacity	132L	124L	132L
Preset Temperature (°C)	12°C	upper 6°C lower 12°C	6°C
Adjustable ttemp in degrees	6 to 18 °C	upper 6-12°C lower 10-18°C	2-10°C
Heater <sup>(1)</sup>	-	Yes	-
Freestanding or Solt-in	Both	Both	Both
Number of shelves: <sup>(1)</sup>	5	4	3
Dimensions (mm) (WxDxH)	595x564x820	595x564x820	595x564x820
Packaged Dimensions (mm) (WxDxH)	650x665x885	650x665x885	650x665x885
Net weight	50kg	50kg	44kg
Gross weight	54kg	54kg	48kg

1. Models with a heater will raise their temperature to the set temperature if the ambient temperature is below the set temperature. Models without a heater will not raise the temperature to the set temperature in these conditions.

If the refrigerant of these appliances are R600a , Flammable and explosive articles should not be put in or near the cabinet, to avoid the fire or explode caused.



Caution:Flammable materials  
Risk of Fire

The symbols you will see in this booklet have these meanings:



**WARNING**  
This symbol indicates information concerning your personal safety.



**CAUTION**  
This symbol indicates information on how to avoid damaging the refrigerator.



**IMPORTANT**  
This symbol indicates tips and information about use of the refrigerator.



**ENVIRONMENT**  
This symbol indicates tips and information about economical and ecological use of the refrigerator.

Conditions of use

This refrigerator is designed and intended to be used in normal domestic applications only.

Ambient Room Temperature Limits

This appliance is designed to operate in ambient temperatures specified by its temperature class marked on the rating plate.

Class	Symbol	Ambient Temperatures range( C )	Relative Humidity
Extended Temperate	SN	+ 10 to + 32	≅ 75%
Temperate	N	+ 16 to + 32	
Subtropical	ST	+ 16 to + 38	
Tropical	T	+ 16 to + 43	

**In environments with higher humidity levels, condensate droplets may appear on the appliance’s exterior door surfaces.**

**If condensate droplets occur, here are some suggestions to address the issue:**

- Ensure adequate ventilation around the appliance to reduce humidity levels.
- Wipe and clean the surfaces to prevent any build-up of moisture and condensation.
- If the appliance settings are too cold, try adjusting them to be warmer to minimize condensation.
- Consider to move or relocate the appliance to a location with lower humidity levels.
- Use dehumidifiers in the room to lower overall humidity, if possible.



FOR SALES IN AUSTRALIA AND NEW ZEALAND  
APPLIANCE: VINTEC

**This document sets out the terms and conditions of the product warranties for Vintec Appliances. It is an important document. Please keep it with your proof of purchase documents in a safe place for future reference should there be a manufacturing defect in your Appliance. This warranty is in addition to other rights you may have under the Australian Consumer Law.**

**1. In this warranty:**

- (a) 'ACL' or 'Australian Consumer Law' means Schedule 2 to the Competition and Consumer Act 2010;
- (b) 'Appliance' means any Electrolux product purchased by you and accompanied by this document;
- (c) 'ASC' means Electrolux's authorised serviced centres;
- (d) 'Vintec' is the brand controlled by Electrolux Home Products Pty Ltd of 163 O'Riordan Street, Mascot NSW 2020, ABN 51 004 762 341 in respect of Appliances purchased in Australia and Electrolux (NZ) Limited (collectively "Electrolux") of 3-5 Niall Burgess Road, Mount Wellington, in respect of Appliances purchased in New Zealand;
- (e) 'Warranty Period' means the period specified in clause 3 of this warranty;
- (f) 'you' means the purchaser of the Appliance not having purchased the Appliance for re-sale, and 'your' has a corresponding meaning.

**2. Application:** This warranty only applies to new Appliances, purchased and used in Australia or New Zealand and is in addition to (and does not exclude, restrict, or modify in any way) other rights and remedies under a law to which the Appliances or services relate, including any non-

**3. Warranty Period:** Subject to these terms and conditions, this warranty continues for in Australia for a period of 24 months and in new Zealand for a period of 24 months, following the date of original purchase of the Appliance. Specific components are warranted against manufacturing defects in Australia and New Zealand for the periods listed below;

- Compressor - Further 3 years

**4. Repair or replace warranty:** During the Warranty Period, Electrolux or its ASC will, at no extra charge if your Appliance is readily accessible for service, without special equipment and subject to these terms and conditions, repair or replace any parts which it considers to be defective. Electrolux may, in its absolute discretion, choose whether the remedy offered for a valid warranty claim is repair or replacement. Electrolux or its ASC may use refurbished parts to repair your Appliance. You agree that any replaced Appliances or parts become the property of Electrolux.

**5. Travel and transportation costs:** Subject to clause 7, Electrolux will bear the reasonable cost of transportation, travel and delivery of the Appliance to and from Electrolux or its ASC. Travel and transportation will be arranged by Electrolux as part of any valid warranty claim.

**6. Proof of purchase** is required before you can make a claim under this warranty.

**7. Exclusions:** You may not make a claim under this warranty unless the defect claimed is due to faulty or defective parts or workmanship. This warranty does not cover:

- (a) light globes, batteries, filters or similar perishable parts;
- (b) parts and Appliances not supplied by Electrolux;
- (c) cosmetic damage which does not affect the operation of the Appliance;
- (d) damage to the Appliance caused by:
  - (i) negligence or accident;
  - (ii) misuse or abuse, including failure to properly maintain or service;
  - (iii) improper, negligent or faulty servicing or repair works done by anyone other than an Electrolux authorised repairer or ASC;
  - (iv) normal wear and tear;
  - (v) power surges, electrical storm damage or incorrect power supply;
  - (vi) incomplete or improper installation;
  - (vii) incorrect, improper or inappropriate operation;
  - (viii) insect or vermin infestation;
  - (ix) failure to comply with any additional instructions supplied with the Appliance;

In addition, Electrolux is not liable under this warranty if:

- (a) the Appliance has been, or Electrolux reasonably believes that the Appliance has been, used for purposes other than those for which the Appliance was intended, including where the Appliance has been used for any non-domestic purpose;
- (b) the Appliance is modified without authority from Electrolux in writing;
- (c) the Appliance's serial number or warranty seal has been removed or defaced.

**8. How to claim under this warranty:** To enquire about claiming under this warranty, please follow these steps:

- (a) carefully check the operating instructions, user manual and the terms of this warranty;
- (b) have the model and serial number of the Appliance available;
- (c) have the proof of purchase (e.g. an invoice) available;
- (d) telephone the numbers shown below.

**9. Australia:** For Appliances and services provided by Electrolux in Australia: Electrolux goods come with guarantees that cannot be excluded under the Australian Consumer Law. You are entitled to a replacement or refund for a major failure and for compensation for any other reasonably foreseeable loss or damage. You are also entitled to have the Appliance repaired or replaced if the Appliance fails to be of acceptable quality and the failure does not amount to a major failure. 'Acceptable quality' and 'major failure' have the same meaning as referred to in the ACL.

**10. New Zealand:** For Appliances and services provided by Electrolux in New Zealand, the Appliances come with a guarantee by Electrolux pursuant to the provisions of the Consumer Guarantees Act, the Sale of Goods Act and the Fair Trading Act. Where the Appliance was purchased in New Zealand for commercial purposes the Consumer Guarantee Act does not apply.

**11. Confidentiality:** You accept that if you make a warranty claim, Electrolux and its agents including ASC may exchange information in relation to you to enable Electrolux to meet its obligations under this warranty.

**Important Notice**

Before calling for service, please ensure that the steps listed in clause 8 above have been followed.

<b>AUSTRALIA</b>	<b>FOR SERVICE</b> or to find the address of your nearest authorised service centre in Australia <b>PLEASE CALL 1800 666 778</b> <small>For the cost of a local call</small>	<b>FOR ACCESSORIES</b> <b>PLEASE CALL 1800 666 778</b> <small>For the cost of a local call (Australia only)</small> or visit <a href="http://www.vintecclub.com">www.vintecclub.com</a>
<b>NEW ZEALAND</b>	<b>FOR SERVICE</b> or to find the address of your nearest authorised service centre in New Zealand <b>PLEASE CALL 0800 10 66 10</b>	<b>FOR ACCESSORIES</b> <b>PLEASE CALL 0800 550 020</b> <small>(New Zealand only)</small> or visit <a href="http://www.vintecclub.com">www.vintecclub.com</a>



---

## Service and support

In the rare event that your Vintec cabinet does not perform to your satisfaction, contact our dedicated support team:

**1800 666 778**

**[customercare@vintec.com.au](mailto:customercare@vintec.com.au)**

Vintec. We are part of the Electrolux Family. To add a touch of professional inspiration to your home, visit [electrolux.com.au](http://electrolux.com.au)

Stay in touch and share your user experience by following us:

