

# KBTAU900XE

Product family	Hood
Hood Type	Decorative wall hood
Design	T flat
Extraction	Extraction
Electronic control	Yes
Material	Stainless steel
Type of steel	Brushed
EAN code	8017709287849
Hood width	90 cm





## Aesthetics

Colour	Stainless steel	Aesthetics	Universale
Finishing	Satin	Logo	Silk screen



## Controls

Control setting	Electronic buttons
-----------------	--------------------

## Programs / Functions

No. of speeds	3
Intensive speed	
24h air filter function	
Time-setting options	

## Technical Features

			No. of lights	2	Anti-grease filters	Aluminium
			Light type	LED	Filter replacement indicator	Yes
			Light Power	1,3 W	Vent outlet	150 mm
			Free outlet maximum capacity	730 m <sup>3</sup> /h	Minimum distance from GAS hob	650 mm
			Motor power	230 W		

No. of filters 3 Minimum distance from ELECTRIC hob 500 mm  
 Non return valve Yes

	Extraction rate IEC 61591 [m³/h]	Noise level IEC 60704-2-13 [dB(A)]
Speed 1	265	47
Speed 2	360	55
Speed 3	480	62
Intensive speed	713	72

## Accessories Included

Tube reduction Yes

## Performance / Energy Label

Annual Efficiency Consumption (AEC<sub>hood</sub>) 54 kWh/a

## Electrical Connection



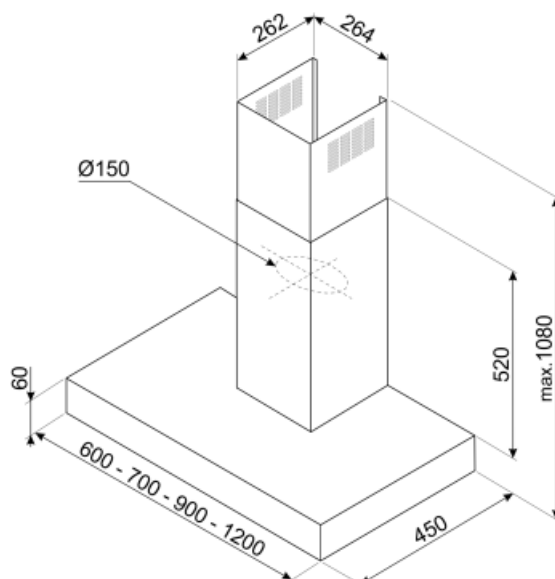



Plug (I) Australia Frequency (Hz) 50-60 Hz  
 Voltage 220-240 V Power supply cable length 1500 mm



---

## Symbols glossary (TT)

---

- |  |   |   |   |
|--|---|---|---|
|  | 24h: When selected this function refreshes the air for c. 10 minutes every hour over a 24 hour period, at minimum speed and an imperceptible noise level. |  | Filters: Model has filters to help remove grease from the steam emanating from the pans during cooking. |
|  | Switch off automatically: A special setting, to run after the end of cooking for a pre-set time and then switch off automatically.                        |  | Warning light(s): to advise when filters need changing.   |
|  | Lights: All cooker hoods feature lights to illuminate the cooking area or add to the ambience of the kitchen.   |  | Intensive/turbo setting: when extra fast extraction is required.  |