

Laundry

TI45S/OF

45L Laundry Tub With Rinse Bypass Kit And Overflow



All dimensions in mm

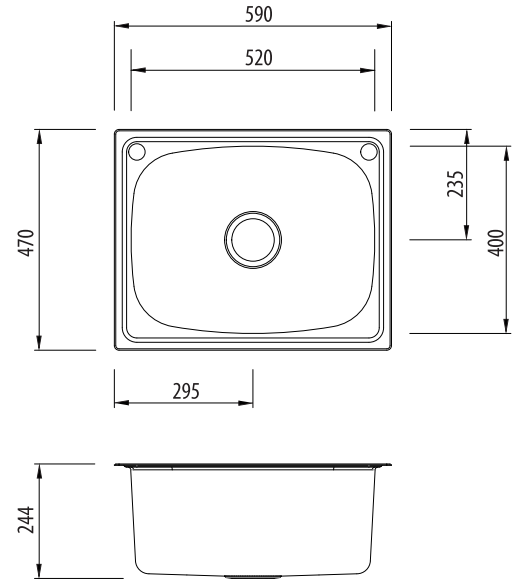

Specifications /

Sink size	590W x 470H mm
Bowl size	45L Tub Bowl 520W x 400H x 235D / 45L
Construction	Single piece with soundproofing
Material	304 grade, 18/10 polished stainless steel (0.9 mm thick)
Installation	Inset recommended
Fixings	Adjustable clips and sealing foam supplied
Min cabinet size	600 mm
Tap holes	2 x 41 mm bypass holes
Waste fittings	1 x 90 mm basket waste included
Overflow	Included
Carton size	600 x 480 x 260 mm
Weight	7.0 kg
Warranty	Lifetime manufacturer's warranty (refer to oliveri.com.au)
Maintenance and care instructions	All surfaces should be cleaned with mild liquid detergent or soap and water. To maintain the shine on your Oliveri stainless steel sink, we recommended the use of any of the easy to obtain, non-abrasive stainless steel cleaners or metal polishes.

Included accessories /

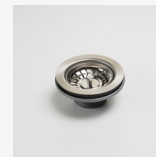

AC14
Basket Waste