

HITACHI

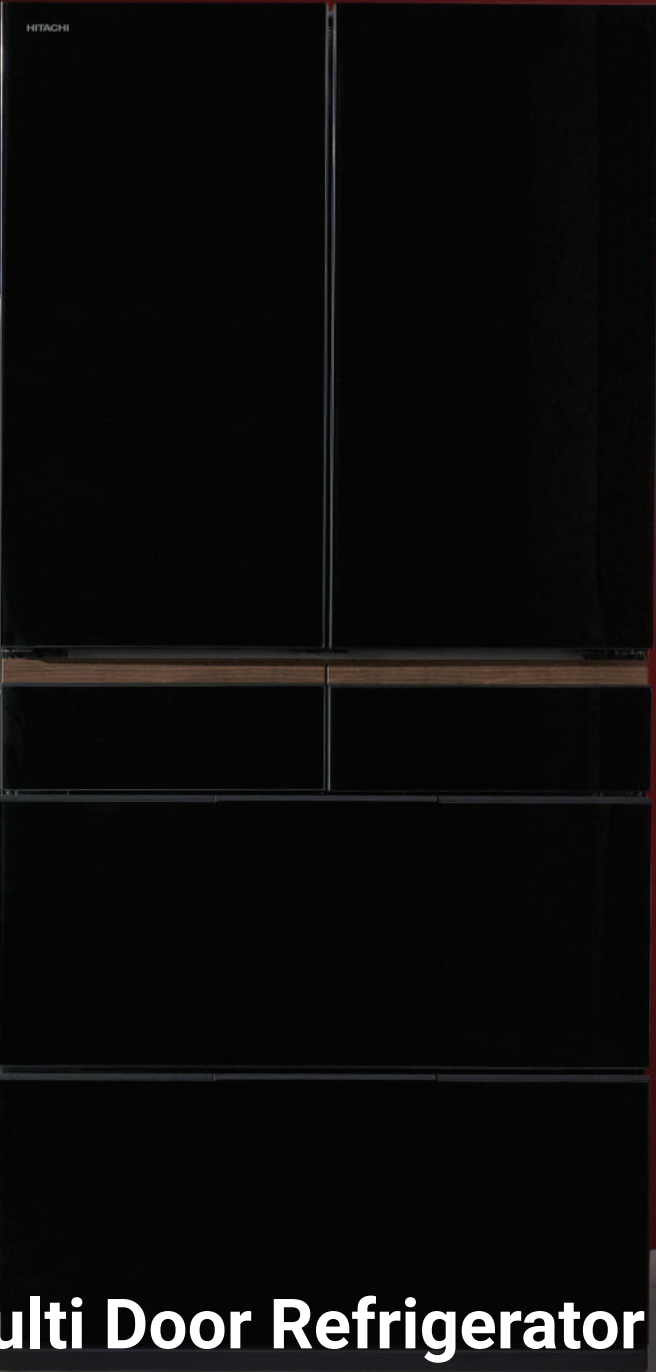

**Multi Door Refrigerator
670L**

The Art of Ease

Product Code R-GW670TA





R-GW670TA XK
Crystal Black



R-GW670TA XM
Mirror Mauve Grey



R-GW670TA XW
Crystal White



Hitachi Original Vacuum Compartment

Vacuum-sealed for Freshness

Platinum Catalyst with Ruthenium Vacuum Compartment

The secret to longer-lasting freshness is reduced oxygen levels.

Hitachi's original preservation extracts air to maintain approx. 0.8 atm of vacuum preservation. With unique Platinum Catalyst, chilled meat, fish and dairy products are kept fresh and nutritious, and ready.

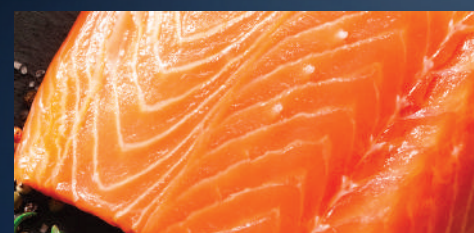

Retain Nutrients and Flavour
Suitable temperature for flavour & texture



Retains Moisture
Prevents dryness without wrapping



Quick Seasoning
Enhances faster seasoning absorption



Approx.
2°C^{*2} Moisture Cool Air
Keeps Food Fresh

Chill temp.

Approx.

2°C^{*2}

Humidity

Refrigerator comp.
Approx.

80%^{*3}

Chills entire refrigerator compartment to retain flavour and freshness. Maintain ingredient freshness by suppressing bacterial growth.

*1 Factory setting will be Moisture Cooling "ON". When the Moisture Cooling is ON, the total power consumption is increased by approx.5%.

*2 For when the room temperature is stable and the room temperature is approx. 32. * Tested by Hitachi. Moisture Cooling is not applicable for door pockets.

3 Approximately 400 g of leaf salad (without wrap) stored for 24 hours. Room temperature about 20, no door open/close. The humidity inside the cabinet is the average humidity of the shelf space. Humidity depends on the amount of storage in the refrigerator compartment, the food (type, condition, and amount of food), the number of times the refrigerator door is open/close, and the operating conditions. Tested by Hitachi. The effect may differ depending on conditions and the amount of food stored.

Aero-care Vege Compartment

The uniquely-designed compartment sustains freshness and nutrients of the vegetables and fruits with Platinum Catalyst. In addition, the Aero-care Vege compartment increases and controls humidity.*

Ethylene gas released by vegetables can spoil their freshness. Platinum catalyst technology has the ability to decompose the ethylene gas and convert it into carbon dioxide gas, delaying spoilage by making vegetables dormant to preserve freshness.



Delicious Freezing / Quick Freeze*



Aluminium Tray and Sensor Helps Automatically Delicious Freeze

When the Temperature Sensor above the Delicious Freeze Tray detects food that is not frozen, settings automatically adjust to freeze food quickly to reduce ice crystal formation. This minimises dripping by reducing ice crystal size, sealing in flavors.

* Tested by Hitachi. When storing approx. 1.7kg of vegetables in the Aero-care Vege Compartment (Lower case) at a room temperature of approx. 20 for 10 days without wrapping or opening/closing the door, the humidity inside the refrigerator will be 68-95%. Humidity varies depending on the amount and type of food being stored, freshness, and operating conditions of the refrigerator. Effects may differ depending on the type, state and the amount of vegetables.

* Tested by Hitachi.



Quick Cooling

Cools down food and drink quickly by increasing the amount of cold air for a certain period.

Flex Freeze

Organize Your Freezer Storage Space.

Delicious Freeze Tray : Stock flat & home freezing items.

Mid Case : For stocking frequently used items & leftovers.

Bottom Case : For stocking up bulk bought frozen foods & large items.

Vertical Storage Space



Energy Saving Technology VIP*

Vacuum Insulation Panel

VIP is a thin vacuum-insulated panel with extremely high heat insulation performance. This can reduce the thickness of insulation and keep the thermal conductivity low.

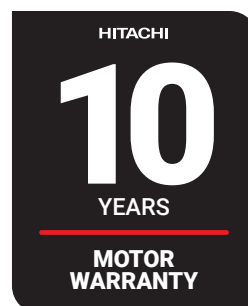
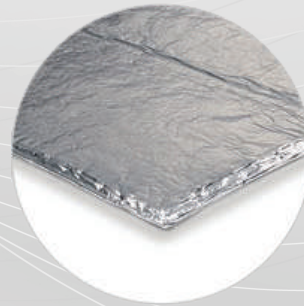

* The position number and shape of the VIPs used vary depending on the model.
* Images are for illustrative purposes only.

Specification

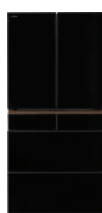

Model		R-GW670TA XK	R-GW670TA XM	R-GW670TA XW
Type		French Door Multi Drawer	French Door Multi Drawer	French Door Multi Drawer
Capacity	Total Volume (L)	670	670	670
	Freezer Volume (L)	194	194	194
	Fresh Food /Vegetable Volume (L)	352 / 124	352 / 124	352 / 124
General / Performance	Colour	Crystal Black	Mirror Mauve Grey	Crystal White
	Cooling System	Dual Fan Cooling	Dual Fan Cooling	Dual Fan Cooling
	Energy Rating	4.5 Star	4.5 Star	4.5 Star
	Energy Consumption at 32°C (kwh/year)	390	390	390
	Climate Class	T	T	T
	Efficient Inverter Compressor	●	●	●
Features	Moisture Cooling	●	●	●
	Auto Drawer Opening	●	●	●
	Energy Saving VIP Technology	●	●	●
Fridge Compartment	Vacuum Compartment	●	●	●
	Aero-Care Vege Compartment	●	●	●
	Triple Power Filter	●	●	●
	Quick Cooling	●	●	●
	Height Adjustable Shelves	3	3	3
	Tempered Glass Shelves	●	●	●
	LED Illumination	LED on Ceiling	LED on Ceiling	LED on Ceiling
Freezer Compartment	Delicious Freezing/Quick Freeze	●	●	●
	Automatic Ice Maker	●	●	●
	Sku	970119100782	970119101119	970119100783
	EAN	4549873175522	4549873198811	4549873175539
	Warranty	5 Years Product, 10 Years Compressor (parts only)		
Dimension & Weight	Width (mm)	880	880	880
	Height (mm)	1843	1843	1843
	Depth (mm) / Cabinet Depth (mm)	654 / 594	654 / 594	654 / 594
	Weight (Net/Gross, kg)	128/135	128/135	128/135

- Specifications and designs are subject to change without notice.
- Colour tone of actual products may differ from those shown.
- Feature images are for illustrative purposes only, they may not reflect the actual product.



Dimension Drawings

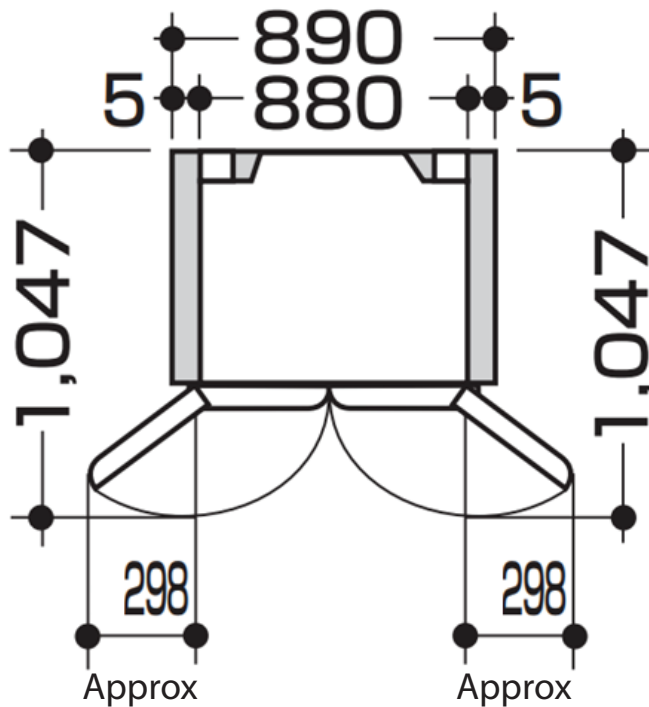
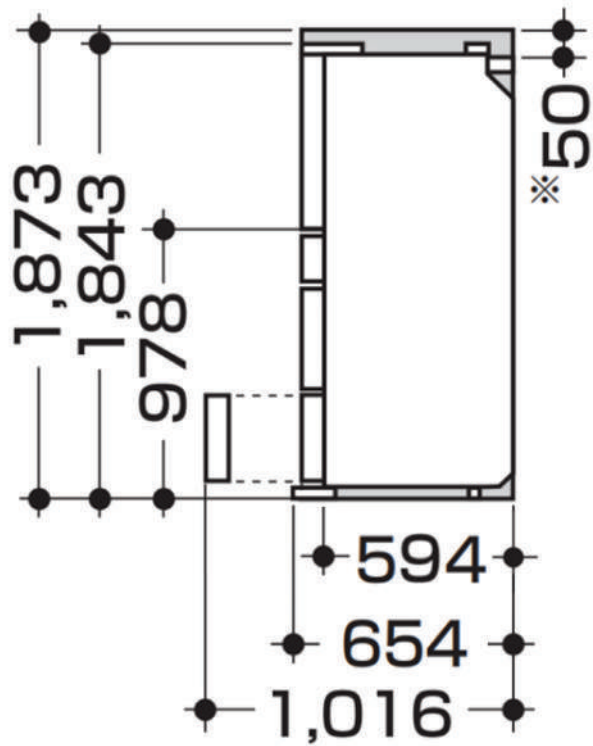

Ventilation Space