



Oven

User manual and installation
instructions

L2ACH7MG0

Table of contents

INFORMATION FOR USE

1	Safety	2
2	Preventing material damage	5
3	Environmental protection and saving energy	5
4	Familiarising yourself with your appliance	6
5	Accessories	9
6	Before using for the first time	10
7	Basic operation	12
8	Rotary spit	12
9	Time-setting options	13
10	Child safety lock	14
11	Basic settings	15
12	Cleaning and servicing	16
13	Cleaning function	18
14	Rails	20
15	Appliance door	20
16	Troubleshooting	22
17	Disposal	24
18	Customer Service	24
19	How it works	24
20	INSTALLATION INSTRUCTIONS	28
20.1	Safe installation	28

1 Safety

Observe the following safety instructions.

1.1 General information

- Read this instruction manual carefully.
- Keep the instruction manual and the product information safe for future reference or for the next owner.
- Do not connect the appliance if it has been damaged in transit.

1.2 Intended use

This appliance is designed only to be built into kitchen units. Read the special installation instructions.

Only a licensed professional may connect appliances without plugs. Damage caused by incorrect connection is not covered under the warranty.

Only use this appliance:

- To prepare meals and drinks.
- in private households and in enclosed spaces in a domestic environment.
- up to an altitude of max. 2000 m above sea level.

Do not use the appliance:

- with an external timer or a remote control.

1.3 Restriction on user group

This appliance may be used by children aged 8 or over and by people who have reduced physical, sensory or mental abilities or inadequate experience and/or knowledge, provided that they are supervised or have been instructed on how to use the appliance safely and have understood the resulting dangers.

Do not let children play with the appliance.

Children must not perform cleaning or user maintenance unless they are at least 15 years old and are being supervised.

Keep children under the age of 8 years away from the appliance and power cable.

1.4 Safe use

Always place accessories in the cooking compartment the right way round.

→ "Accessories", Page 9

WARNING – Risk of fire!

Combustible objects that are left in the cooking compartment may catch fire.

- ▶ Never store combustible objects in the cooking compartment.
- ▶ If smoke is emitted, the appliance must be switched off or the fuse must be switched off and the door must be held closed in order to stifle any flames.

Loose food remnants, fat and meat juices may catch fire.

- ▶ Before using the appliance, remove the worst of the food residues and remnants from the cooking compartment, heating elements and accessories.

Opening the appliance door creates a draught. Greaseproof paper may come into contact with the heating element and catch fire.

- ▶ Never place greaseproof paper loosely over accessories when preheating the appliance and while cooking.
- ▶ Always cut greaseproof paper to size and use a plate or baking tin to hold it down.

⚠ WARNING – Risk of burns!

The appliance and its parts that can be touched become hot during use.

- ▶ Caution should be exercised here in order to avoid touching heating elements.
- ▶ Young children under 8 years of age must be kept away from the appliance.

Accessories and cookware get very hot.

- ▶ Always use oven gloves to remove accessories or cookware from the cooking compartment.

When the cooking compartment is hot, any alcoholic vapours inside may catch fire. The appliance door may spring open. Hot steam and jets of flame may escape.

- ▶ Only use small quantities of drinks with a high alcohol content in food.
- ▶ Do not heat spirits ($\geq 15\%$ vol.) when undiluted (e.g. for marinating or pouring over food).
- ▶ Open the appliance door carefully.

The telescopic shelves become hot when the appliance is in use.

- ▶ Allow hot telescopic shelves to cool down before touching them.
- ▶ Only touch hot telescopic shelves with oven gloves.

⚠ WARNING – Risk of scalding!

The accessible parts of the appliance become hot during operation.

- ▶ Never touch these hot parts.
- ▶ Keep children at a safe distance.

Hot steam may escape when you open the appliance door. Steam may not be visible, depending on the temperature.

- ▶ Open the appliance door carefully.
- ▶ Keep children at a safe distance.

If there is water in the cooking compartment when it is hot, this may create hot steam.

- ▶ Never pour water into the cooking compartment when the cooking compartment is hot.

⚠ WARNING – Risk of injury!

Scratched glass in the appliance door may develop into a crack.

- ▶ Do not use any harsh or abrasive cleaners or sharp metal scrapers to clean the glass on the oven door, as they may scratch the surface.

The appliance and its parts that can be touched may have sharp edges.

- ▶ Take care when handling and cleaning them.
- ▶ If possible, wear protective gloves.

The hinges on the appliance door move when the door is opened and closed, which could trap your fingers.

- ▶ Keep your hands away from the hinges. Components inside the appliance door may have sharp edges.
- ▶ Wear protective gloves.

⚠ WARNING – Risk of electric shock!

Improper repairs are dangerous.

- ▶ Repairs to the appliance should only be carried out by trained specialist staff.
- ▶ Only use genuine spare parts when repairing the appliance.
- ▶ If the power cord of this appliance is damaged, it must be replaced by the manufacturer, the manufacturer's Customer Service or a similarly qualified person in order to prevent any risk.

If the insulation of the power cord is damaged, this is dangerous.

- ▶ Never let the power cord come into contact with hot appliance parts or heat sources.
- ▶ Never let the power cord come into contact with sharp points or edges.
- ▶ Never kink, crush or modify the power cord.

An ingress of moisture can cause an electric shock.

- ▶ Do not use steam- or high-pressure cleaners to clean the appliance.

If the appliance or the power cord is damaged, this is dangerous.

- ▶ Never operate a damaged appliance.
- ▶ Call customer services. → *Page 24*

⚠ WARNING – Risk of suffocation!

Children may put packaging material over their heads or wrap themselves up in it and suffocate.

- ▶ Keep packaging material away from children.
- ▶ Do not let children play with packaging material.

Children may breathe in or swallow small parts, causing them to suffocate.

- ▶ Keep small parts away from children.
- ▶ Do not let children play with small parts.

1.5 Halogen bulb

⚠ WARNING – Risk of burns!

The bulbs in the cooking compartment get very hot. There is still a risk of burning for some time after they have been switched off.

- ▶ Do not touch the glass cover.
- ▶ Avoid contact with your skin when cleaning.

⚠ WARNING – Risk of electric shock!

When changing the bulb, the bulb socket contacts are live.

- ▶ Before replacing the bulb, ensure that the appliance is switched off in order to prevent a potential electric shock.
- ▶ Also switch off the fuse in the fuse box.

1.6 Cleaning function

⚠ WARNING – Risk of fire!

Loose food remnants, fat and meat juices may catch fire when the cleaning function is in progress.

- ▶ Before you start the cleaning function, always remove coarse dirt from the cooking compartment.
- ▶ Never clean accessories at the same time.

The outside of the appliance gets very hot when the cleaning function is in progress.

- ▶ Never hang combustible objects, e.g. tea towels, on the door handle.
- ▶ Leave the front of the appliance clear.
- ▶ Keep children at a safe distance.

If the door seal is damaged, a large amount of heat is generated around the door.

- ▶ Do not scrub or remove the seal.
- ▶ Never operate the appliance if the seal is damaged or missing.

⚠ WARNING – Risk of serious harm to health!

The appliance gets very hot when the cleaning function is in progress. The non-stick coating on baking trays and tins is destroyed and noxious gases are released.

- ▶ Never clean non-stick baking trays or baking tins using the cleaning function.
- ▶ Only clean enamelled accessories at the same time.

⚠ WARNING – Risk of harm to health!

The cleaning function heats up the cooking compartment to a very high temperature so that food left over from roasting, grilling and baking will burn off. This process releases vapours, which can irritate mucous membranes.

- ▶ Keep the kitchen well ventilated while the cleaning function is running.
- ▶ Do not remain in the room for long periods.
- ▶ Keep children and pets away.

⚠ WARNING – Risk of burns!

The cooking compartment gets very hot when the cleaning function is in progress.

- ▶ Never open the appliance door.
- ▶ Allow the appliance to cool down.
- ▶ Keep children at a safe distance.

⚠ The outside of the appliance gets very hot when the cleaning function is in progress.

- ▶ Never touch the appliance door.
- ▶ Allow the appliance to cool down.
- ▶ Keep children at a safe distance.

2 Preventing material damage

2.1 General

ATTENTION!

Alcoholic vapours may catch fire in the hot cooking compartment and cause permanent damage to the appliance. The appliance door may spring open due to an explosion and it may fall off. The door panels may shatter and fragment. Due to the resulting negative pressure, the cooking compartment may become considerably deformed inwards.

- ▶ Do not heat spirits ($\geq 15\%$ vol.) when undiluted (e.g. for marinating or pouring over food).

If there is water on the cooking compartment floor when operating the appliance at temperatures above $120\text{ }^{\circ}\text{C}$, this will damage the enamel.

- ▶ Do not use the appliance if there is water on the cooking compartment floor.
- ▶ Wipe away any water on the cooking compartment floor before operation.

Objects on the cooking compartment floor at over $50\text{ }^{\circ}\text{C}$ will cause heat to build up. The baking and roasting times will no longer be correct and the enamel will be damaged.

- ▶ Do not place any accessories, greaseproof paper or foil of any kind on the cooking compartment floor.
- ▶ Only place cookware on the cooking compartment floor if a temperature under $50\text{ }^{\circ}\text{C}$ has been set.

When the cooking compartment is hot, any water inside it will create steam. The change in temperature may cause damage.

- ▶ Never pour water into the cooking compartment when it is still hot.
- ▶ Never place cookware containing water on the cooking compartment floor.

The prolonged presence of moisture in the cooking compartment leads to corrosion.

- ▶ Always wipe away the condensation after cooking. Always allow the cooking compartment to cool down with the door closed after cooking at high temperatures.

- ▶ Do not keep moist food in the cooking compartment for a long time with the door closed.
- ▶ Do not store food in the cooking compartment.
- ▶ Take care not to trap anything in the appliance door.

Fruit juice dripping from the baking tray leaves stains that cannot be removed.

- ▶ When baking very juicy fruit flans, do not pack too much on the baking tray.
- ▶ If possible, use the deeper universal pan.

Using oven cleaner in a hot cooking compartment damages the enamel.

- ▶ Never use oven cleaner in the cooking compartment when it is still warm.
- ▶ Remove all food remnants from the cooking compartment and the appliance door before you next heat up the appliance.

If the seal is very dirty, the appliance door will no longer close properly during operation. This may damage the front of adjacent kitchen units.

- ▶ Keep the seal clean at all times.
- ▶ Never operate the appliance if the seal is damaged or missing.

Sitting or placing objects on the appliance door may damage it.

- ▶ Do not place, hang or support objects on the appliance door.
- ▶ Do not place cookware or accessories on the appliance door.

With certain models, accessories may scratch the door pane when closing the appliance door.

- ▶ Always push accessories fully into the cooking compartment.

If aluminium foil comes into contact with the door pane, it could cause permanent discolouration.

- ▶ Do not allow aluminium foil in the cooking compartment to come into contact with the door pane.

3 Environmental protection and saving energy

3.1 Disposing of packaging

The packaging materials are environmentally compatible and can be recycled.

- ▶ Sort the individual components by type and dispose of them separately.

3.2 Saving energy

If you follow these instructions, your appliance will use less power.

Only preheat the appliance if the recipe or the recommended settings tell you to do so.

→ "How it works", Page 24

- Not preheating the appliance can reduce the energy used by up to 20%.

Use dark-coloured, black-coated or enamelled baking tins.

- These types of baking tin absorb the heat particularly well.

Open the appliance door as little as possible during operation.

- This maintains the temperature in the cooking compartment and eliminates the need for the appliance to reheat.

When baking multiple dishes, do so in succession or in parallel.

- The cooking compartment is heated after baking the first dish. This reduces the baking time for the subsequent cakes.

For longer cooking times, you can switch the appliance off 10 minutes before the cooking time ends.

- There is sufficient residual heat to finish cooking the dish.

Remove any accessories that are not being used from the cooking compartment.

- Accessories that are not being used do not need to be heated.

Allow frozen food to defrost before cooking.

- This saves the energy that would otherwise be required to defrost it.

Note:

The appliance requires:

- A maximum of 1 W in standby mode with the display switched on
- A maximum of 0.5 W in standby mode with the display switched off

4 Familiarising yourself with your appliance

4.1 Control panel

You can use the control panel to configure all functions of your appliance and to obtain information about the operating status.

Note: On certain models, specific details such as colour and shape may differ from those pictured.

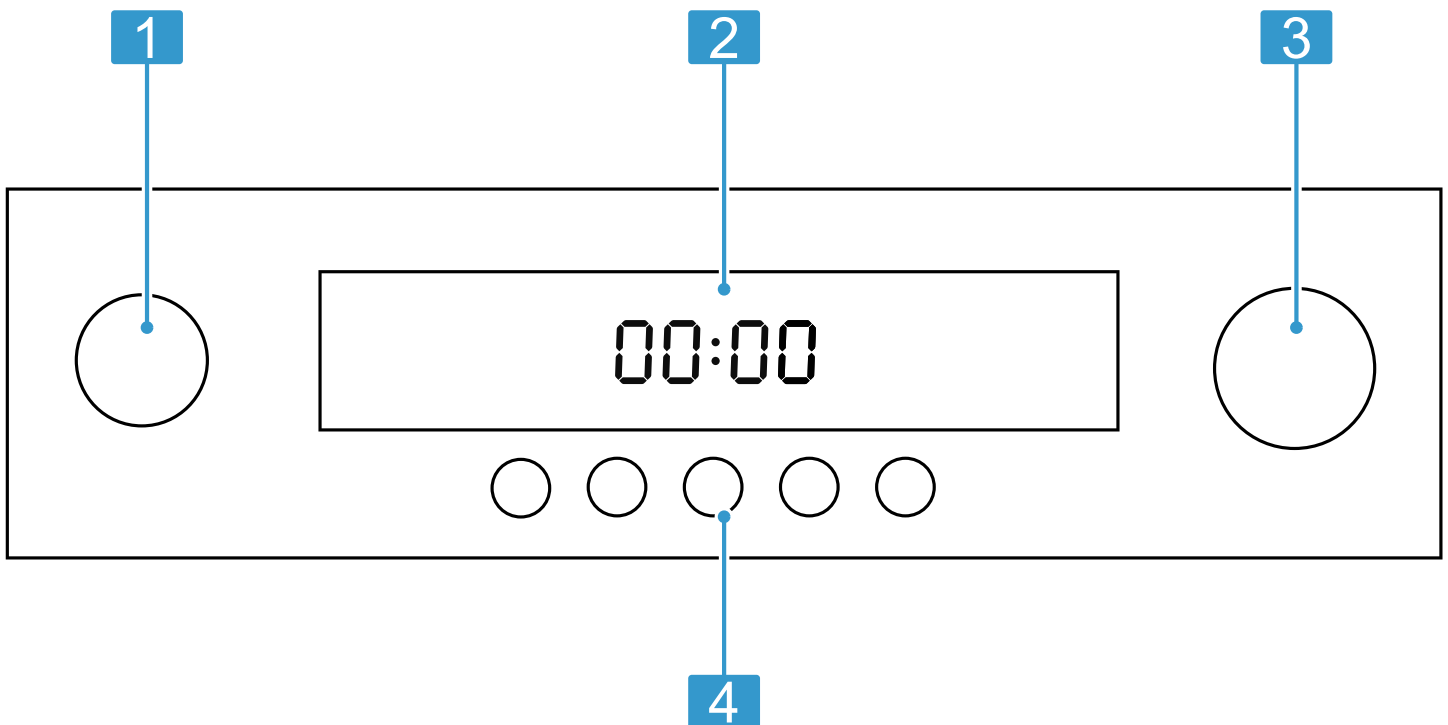



1	Function selector	Use the function selector to set the type of heating or other functions. You can turn the function selector clockwise or anti-clockwise from the zero setting.
2	Display	The display shows symbols for active functions and the time-setting options.
3	Temperature selector	Use the temperature selector to set the temperature for the type of heating or select the setting for other functions. You can turn the temperature selector clockwise and anti-clockwise. It does not have an off position.
4	Touch fields	You can use the touch fields to set various functions directly.

Buttons

You can use the buttons to directly select various functions.









Symbol	Button	Explanation
⌚	Time-setting options	Set the timer, cooking time, end time or time
<		Decrease the setting value

Symbol	Button	Explanation
>		Increase the setting value
	Rapid heating	Switch the rapid heating on and off
	Information	Display the current cooking compartment temperature

Display

You can see the current setting values or options in the display.

The value that you can currently set is in focus. The value is displayed in white lettering with a dark background.

Symbol	Explanation
	Rapid heating
	Timer
	Duration
	End
	Time
88:88	Time indicator
	Heat-up indicator
	Childproof lock
	Door lock
888	Temperature indicator

Temperature selector

Use the temperature selector to set the temperature or grill setting.

Note: The temperature can be set in 1-degree increments up to 100 °C, and in 5-degree increments thereafter.

Temperature control







The temperature indicator bars show the heating phases or residual heat in the cooking compartment.





Heating phase	Meaning
Heating indicator	The heating indicator displays the rising temperature in the cooking compartment. When all bars are filled, the optimum time for placing the dish in the oven has been reached. In the grill and cleaning settings, the bars are all already filled at the start. The bars are not filled for the gentle top/bottom heating type of heating.
Residual heat indicator	When the appliance is switched off, the temperature indicator shows the residual heat in the cooking compartment. Once the temperature has dropped to approximately 60 °C, the display goes out.

4.2 Types of heating and functions

To ensure that you always use the right type of heating to cook your food, we have explained the differences and applications below.

Note: For each type of heating, the appliance specifies a default temperature or default setting. You can accept this value or change it in the appropriate area.

Symbol	Type of heating or function	Temperature or setting	Use
	3D hot air	50-280 °C	Prepare dishes on 1-2 levels. The fans distribute the heat from the ring-shaped heating elements in the back panel evenly around the cooking compartment. This type of heating is used to measure the energy consumption in air recirculation mode.
	Air recirculation	50-280 °C	Bake cakes and baked items on one level. The fans distribute the heat from the heating elements evenly around the cooking compartment.
	Pizza setting	50-280 °C	Prepare fresh pizza or frozen products, e.g. chips or strudel. The heating elements and fans heat quickly and distribute the heat evenly around the cooking compartment.
	Defrost setting	30-60 °C	Defrost food, e.g. meat, poultry, bread and cakes. The fan causes the warm air to swirl around the dish.
	Bottom heating	50-280 °C	Cook dishes for additional time. The heat is emitted from below.
	Full-surface grill	50 °C - Int	Grill flat items, such as steak, sausages or toast and gratinate. The entire area below the grill element becomes hot.

Symbol	Type of heating or function	Temperature or setting	Use
	Circulated air grill	50-280 °C	Roast meat, poultry and whole fish. The fan circulates the hot air around the food.
	Top/bottom heat gentle	50-280 °C	For gently cooking selected types of food (e.g. meat, vegetables) on one level without preheating. The type of heating is unsuitable for food that rises as it bakes (e.g. bread). This type of heating is used to measure both the energy consumption in the conventional mode and the energy efficiency class.
	Top/bottom heating	50-280 °C	Prepare cakes, bakes and lean joints. The heat is emitted evenly from above and below.
	Rotary spit	50 °C - Int	Roasts, rolled roasting joints and poultry
	Cleaning		→ "Cleaning function", Page 18

4.3 Cooking compartment

The functions in the cooking compartment make your appliance easier to use.

Shelf positions

The cooking compartment has 5 shelf positions. Always insert the accessory as far as it will go so that the accessory does not touch the door panel. Slide the accessory into the cooking compartment correctly.

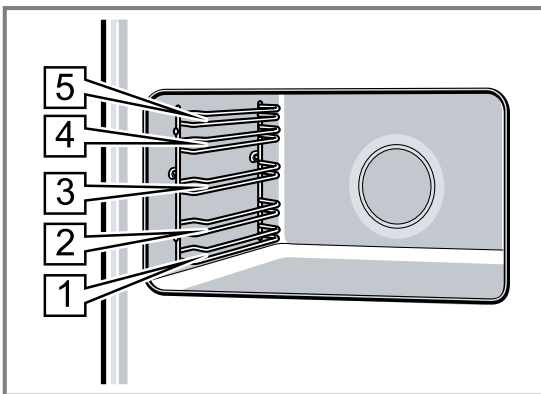

Interior lighting

When you open the appliance door, the interior lighting switches on. If the appliance door remains open, the light switches off again after a short time.

In most operating modes, the interior lighting switches on as soon as operation starts. Once the operation is complete, this switches off.

Note: In "Top/bottom heat gentle" mode, the interior lighting switches off automatically after approx. 1 minute. If you need to look inside the oven, open the door for as brief a time as possible.

Cooling fan

The cooling fan switches on and off as required. The hot air escapes via the appliance door.

ATTENTION!

Covering the ventilation slots will cause the appliance to overheat.

► Do not cover the ventilation slots.

To cool the cooking compartment more quickly after operation, the cooling fan continues to run for a certain period afterwards.

Appliance door

If you open the appliance door while the appliance is in operation, this pauses operation. When you close the door, the operation continues.

To ensure that the appliance door does not come into contact with the fitted unit, the appliance door opens slightly less than 90°.

Condensation

This section tells you how condensation is formed, how you can prevent damage, and how you can prevent condensation from forming.

When you are cooking food in the cooking compartment, a lot of steam may form in the cooking compartment. Since your appliance is extremely energy-efficient, only a small amount of heat escapes during operation. Due to the significant differences in temperature between the appliance interior and the external parts of the appliance, condensation may build up on the appliance door, the control panel or the front panels of adjacent kitchen units. The formation of condensation is a normal physical phenomenon.

In order to prevent damage, wipe away the condensation. If condensation collects in the drip trough, remove the condensation with a sponge. An overflowing drip trough may damage the fitted unit. Leave the appliance to dry with the door open.





When you preheat the appliance, you reduce the build-up of condensation.

5 Accessories

Use original accessories. These have been made especially for your appliance.

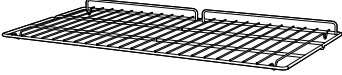
Note: Accessories may become deformed if they get hot. Deformation has no effect on function. As the accessory cools down, it will regain its original shape.

The accessories supplied may differ depending on the appliance model.

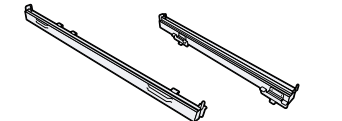
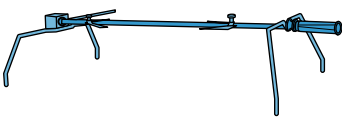
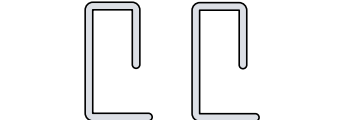
Accessories	Use
Wire rack 	<ul style="list-style-type: none"> ■ Cookware ■ Cake tins ■ Meat, e.g. roasting joints or steak ■ Frozen meals
Wire insert 	<ul style="list-style-type: none"> ■ Place it into the universal pan ■ Place it into the baking tray ■ In order to prepare large quantities of meals
Universal pan 	<ul style="list-style-type: none"> ■ Moist cakes ■ Baked items ■ Frozen meals ■ Large roasts <p>Tip: You can use the universal pan to catch dripping fat if you are grilling directly on the wire rack.</p>
Baking tray 	<ul style="list-style-type: none"> ■ Tray bakes ■ Small baked items
Telescopic rail set 	<p>Use the pull-out rails to pull the accessory out further.</p>
Rotary spit 	<ul style="list-style-type: none"> ■ For roasting pieces of meat ■ For roasting large items of poultry <p>Note: Use only in combination with the enamelled baking tray.</p>
Locking pins 	<p>Lock hinges.</p> <p>Note: Do not throw away the locking pins. Store the locking pins in a secure location. You always require the locking pins when you remove the door or door panels from the appliance.</p>

5.1 Other accessories

You can purchase other accessories from our after-sales service, specialist retailers or online.

You will find a comprehensive range of products for your appliance in our brochures and online:

www.neff-international.com

Accessories vary from one appliance to another. When purchasing accessories, always quote the exact product number (E no.) of your appliance.

You can find out which accessories are available for your appliance in our online shop or from our after-sales service.

Other accessories	Use
Wire rack	<ul style="list-style-type: none"> ■ Cookware ■ Cake tins ■ Meat, e.g. roasting joints or steak ■ Frozen meals
Baking tray	<ul style="list-style-type: none"> ■ Tray bakes ■ Small baked items
Universal pan	<ul style="list-style-type: none"> ■ Moist cakes ■ Baked items ■ Frozen meals ■ Large roasts
Telescopic rail set	Telescopic rail set for one level

5.2 Locking function

The locking function prevents the accessories from tilting when they are pulled out.

You can pull out the accessory approximately halfway without them tipping. The accessory must always be inserted into the cooking compartment the right way round for the tilt protection to work properly.

5.3 Sliding accessories into the cooking compartment

1. Turn the accessory in such a way that the notch **a** is at the rear and is facing downwards.
2. Insert the accessory between the two guide rods for a shelf position.

Wire rack
The open side must be facing the appliance door and the curvature must be at the bottom (i.e. .

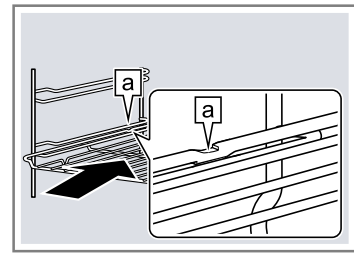

Tray, e.g. universal pan or baking tray
The sloping edge of the accessory **b** must be facing towards the appliance door.

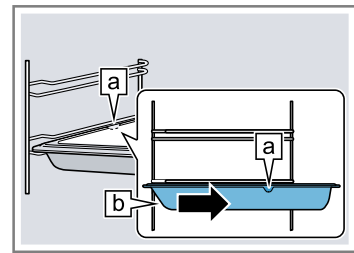

3. To place the accessory at shelf positions with pull-out rails, pull out the pull-out rails.

Wire rack or baking tray
Position the accessory so that its edge is behind the lug **a** on the pull-out rail.

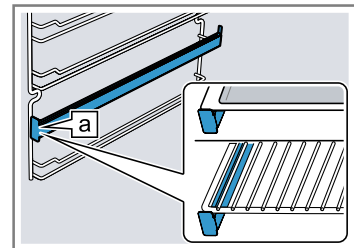

Note: The pull-out rails lock in place when they are fully pulled out. Gently push the pull-out rails back into the cooking compartment.



4. Push the accessory all the way in, making sure that it does not touch the appliance door.

Note: Take any accessories that you will not be using out of the cooking compartment while the appliance is in operation.

6 Before using for the first time

Configure the settings for initial start-up. Clean the appliance and accessories.

6.1 Setting the time

Once the appliance is connected to a power supply,  flashes on the display and the  symbol lights up continuously. Set the time.

1. Use **>** or **<** to set the time.
2. Press .

Note: Once the set time has elapsed, the time is automatically saved.

6.2 Cleaning the appliance before using it for the first time

Clean the cooking compartment and accessories before using the appliance to prepare food for the first time.

1. Remove the accessories from the cooking compartment and remove the shelves. → *Page 20*
2. Completely remove any leftover packaging, e.g. small pieces of polystyrene, from the cooking compartment.
3. Some parts are covered with a protective film. Remove this scratch protection film.
4. Clean the outside of the appliance with a soft, damp cloth.
5. Clean the cooking compartment with hot soapy water.
6. To eliminate the new-appliance smell, heat up the empty appliance with the door closed.

7. Turn the function selector to \equiv .
8. Set the maximum temperature.
If you are heating up the appliance for the first time, you may hear crackling noises from the cooking compartment.
9. Ventilate the kitchen while the appliance is heating.
10. Switch off the appliance after 1 hour.
11. Allow the appliance to cool down.
12. Once the cooking compartment has cooled down, clean the smooth surfaces with soapy water.
13. Install the rails. → *Page 20*
14. If necessary, clean the door panels. → *Page 20*

6.3 Cleaning the accessories

- ▶ Clean the accessory thoroughly with soapy water and a soft dish cloth.

7 Basic operation

7.1 Switching on the appliance

1. Use the function selector to set the type of heating.
 - ✓ Each function has a default temperature or grill setting.
2. Use the temperature selector to select the temperature or grill setting.
 - ✓ The appliance starts heating.

Note: The temperature control displays the current heating status.

7.2 Changing the type of heating and temperature

1. Use the function selector to change the type of heating.

2. Use the temperature selector to change the temperature or grill setting.

7.3 Switching off the appliance

- ▶ Turn the function selector to the off position.

7.4 Switching on the rapid heating function

- ▶ Press the  button to heat up the cooking compartment quickly.

Note: Rapid heating is available for 3D hot air, air recirculation, the pizza setting and top/bottom heating.

7.5 Automatic switch-off

The appliance has automatic switch-off. The appliance automatically switches off after 13 hours.

8 Rotary spit

8.1 Preparing the rotary spit

1. Slide a retaining clip onto the rotary spit and screw on the handle.

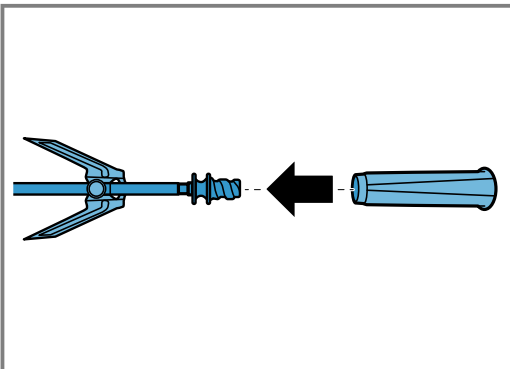

2. Place the roasting joint into the centre of the rotary spit.
3. Secure the roasting joint using the retaining clips.
4. Secure the retaining clips using the knurled screws.

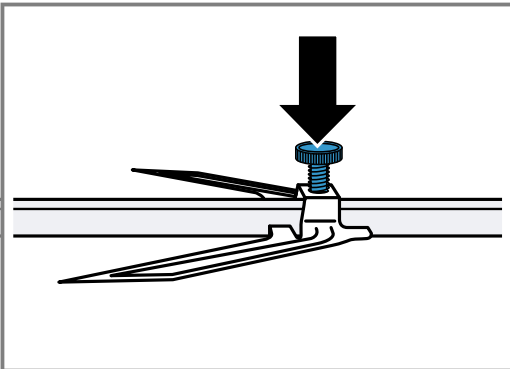

8.2 Inserting the rotary spit

WARNING – Risk of burns!

The appliance and its parts that can be touched become hot during use.

- ▶ Caution should be exercised here in order to avoid touching heating elements.
- ▶ Young children under 8 years of age must be kept away from the appliance.

1. Insert the rotary spit frame into the threaded bushes.

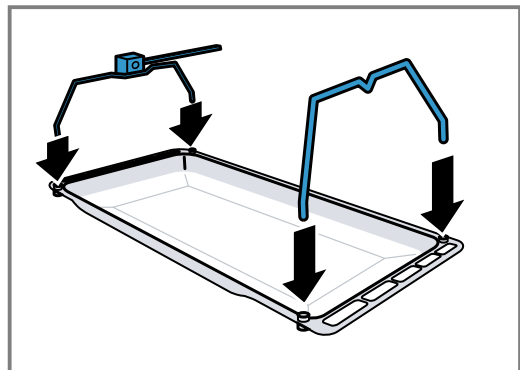

- Place the rotary spit onto the rotary spit frame and unscrew the handle.

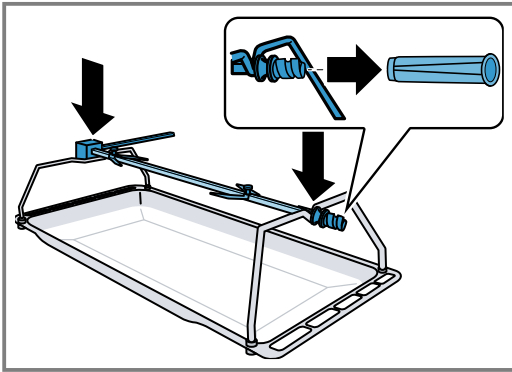

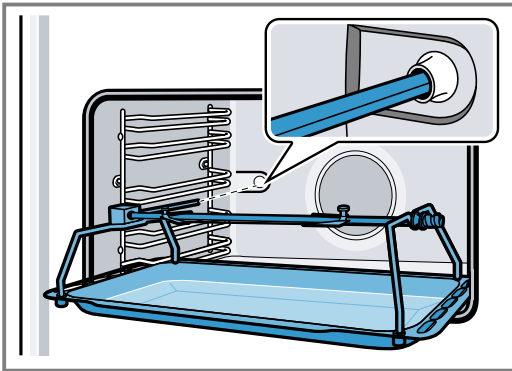

- Slide the universal pan into shelf position 1 and place the rotary spit into the motor bracket.



- Pour some water into the universal pan to better catch any fat that drips out.
- Close the appliance door.

8.3 Switch on the rotary spit

Note: If you are using the rotary spit, preheat the oven with the  type of heating. Insert the rotary spit before you set the heating function .

- Set the function selector to .
- Select the grill setting.

8.4 Removing the rotary spit

WARNING – Risk of burns!

The appliance and its parts that can be touched become hot during use.





- ▶ Caution should be exercised here in order to avoid touching heating elements.
- ▶ Young children under 8 years of age must be kept away from the appliance.

- Open the appliance door.
- Slowly pull out the universal pan until this protrudes halfway out of the cooking compartment.
- Pull the universal pan fully out of the cooking compartment and place it on the worktop.
- Screw the handle onto the rotary spit.
- Remove the rotary spit from the rotary spit frame by the handle.

9 Time-setting options

9.1 Overview of the time-setting options





You can find an overview of the time-setting options here.

Symbol	Time-setting option	Use
	Short-term timer	The short-term timer functions like an egg timer. It runs independently of the appliance when it is in operation and of other time-setting options, and does not affect the appliance.
	Time	When no other function is running in the foreground, the appliance shows you the time of day on the display.
	Duration	Once the set cooking time has elapsed, the appliance automatically stops heating.
	End	Enter a cooking time and the required end time. The appliance starts up automatically so that it finishes cooking at the required time.



9.2 Setting the short-term timer

The timer has no influence on the functions of the oven.

Note: You can set the time on the short-term timer from 30 seconds up to 13 hours. You can set the duration in 30-second increments up to 10 minutes, in 1-minute increments from 10 minutes to 1 hour, and then in 5-minute increments.

- Press .
- ✓  lights up.
- Use  and  to set the required duration.
- ✓ A signal tone sounds once the time has elapsed.

Notes

- To change the remaining time, press  and use  or  to change the remaining time.
- To cancel the short-term timer, set the remaining time to zero.

Switching off the signal tone





- ▶ To switch off the signal tone, press any button or open the appliance door.

Note: After a short time, the signal tone stops automatically.

9.3 Setting the time

If required, you can change the time, e.g. from summer time to winter time.

Requirement: The appliance is switched off.

1. Press  until  lights up.
2. Use  and  to set the time.

9.4 Setting the duration

You can set the cooking time for your food on your appliance. This prevents the food from accidentally being cooked for too long, and means that you do not have to stop what you are doing to switch off the oven.

1. Set the type of heating and the temperature.

✓ The appliance starts.

2. Press  twice.

3. Use  and  to set the duration.

You can set the duration from 30 seconds up to 13 hours. You can set the cooking time in 1-minute increments up to 1 hour, and then in 5-minute increments.

✓  lights up.

Turning off the operation

When the time has elapsed, a signal tone sounds. The appliance stops heating.

1. To switch off the signal tone, press any button or open the appliance door.

After a short time, the signal tone stops automatically.

2. Turn the function selector to the off position.



9.5 Setting the end time

Operation starts for the set duration at a later time that is selected by you.

1. Set the type of heating and the temperature.

✓ The appliance starts.



2. Press  twice.

3. Use  and  to set the duration.

You can set the duration from 30 seconds up to 13 hours. You can set the cooking time in 1-minute increments up to 1 hour, and then in 5-minute increments.

✓  lights up.

4. Press .

5. Use  or  to set the end time.

The first time you press the button, the display shows a default value. This default value is calculated using the current time on the clock and the duration.

✓  lights up.

✓ The display shows the end time. The appliance switches to standby mode.

Turning off the operation

When the time has elapsed, a signal tone sounds. The appliance stops heating.

1. To switch off the signal tone, press any button or open the appliance door.

After a short time, the signal tone stops automatically.

2. Turn the function selector to the off position.

10 Child safety lock

You can secure your appliance to prevent children from accidentally switching it on or changing the settings.

If you have connected a hob to the oven, the hob is not locked.

10.1 Activating the child safety lock

Requirement: The appliance is switched off.

- ▶ Press and hold  for approx. 4 seconds.

✓  appears on the display.

10.2 Deactivating the child safety lock

- ▶ Press and hold  for approx. 4 seconds.

✓  disappears from the display.

10.3 Automatic childproof lock

The automatic childproof lock activates the childproof lock when the function selector is set to the off position.

You can switch the automatic childproof lock on in the basic settings.

→ "Basic settings", Page 15

11 Basic settings

You can configure the basic settings for your appliance to meet your needs.

11.1 Overview of the basic settings

Here you can find an overview of the basic settings and factory settings. The basic settings depend on the features of your appliance.

Display	Basic setting	Selection
c00	Automatic childproof lock when the function selector is in the off position	0 = off ¹ 1 = on
c01	Signal duration upon completion of a cooking time or timer period	1 = approx. 10 seconds 2 = approx. 30 seconds ¹ 3 = approx. 2 minutes
c02	Waiting time until a setting is adopted	1 = approx. 3 seconds ¹ 2 = approx. 6 seconds 3 = approx. 10 seconds
c03	Button tone that sounds when a button is touched	0 = off 1 = on ¹
c04	Brightness of the display illumination	1 = dark 2 = medium ¹ 3 = bright
c05	Time display	0 = hide the time 1 = display the time ¹
c06	Interior lighting during operation	0 = No 1 = Yes ¹
c07	Cooling fan run-on time	1 = short ¹ 2 = moderate 3 = long 4 = extra long
c08	Reset all values to factory settings	0 = No ¹ 1 = Yes
c09	Activate demo mode. The demo mode is used for demonstration purposes only. The appliance does not heat up in demo mode. You can activate the demo mode only in the first 5 minutes after connecting to the power supply.	0 = No ¹ 1 = Yes

¹ Factory setting

11.2 Changing the basic settings

Requirement: The function selector is set to the off position.

1. Press and hold **1** for approx. 4 seconds.
✓ The display shows the first basic setting, e.g. c01 1.
2. Turn the temperature selector to change the setting.
3. Press **)** to switch to the next basic setting.
4. Press and hold **1** for approx. 4 seconds to confirm the settings.

Tip: You can change the basic settings again at any time.

Notes

- You can activate the demo mode only in the first 5 minutes after connecting to the power supply.

- Your changes to the basic settings are retained even after a power cut.

11.3 Setting energy-saving mode

You can save energy by reducing the display brightness.

- ▶ You can set the display brightness under basic setting c04.

Note: This setting changes the brightness of the display while the appliance is in operation. In standby mode, the appliance automatically reduces the display brightness. The display is at its dimmest at night, between the hours of 22:00 and 05:59.

12 Cleaning and servicing

To keep your appliance working efficiently for a long time, it is important to clean and maintain it carefully.

12.1 Cleaning products

To avoid damaging the various surfaces on the appliance, do not use any unsuitable cleaning agents.

⚠ WARNING – Risk of electric shock!

An ingress of moisture can cause an electric shock.

- ▶ Do not use steam- or high-pressure cleaners to clean the appliance.

ATTENTION!

Unsuitable cleaning agents damage the surfaces of the appliance.

- ▶ Do not use harsh or abrasive cleaning products.
- ▶ Do not use cleaning products with a high alcohol content.

- ▶ Do not use hard scouring pads or cleaning sponges.
- ▶ Do not use any special cleaners for cleaning the appliance while it is hot.
- ▶ Only use glass cleaners, glass scrapers or stainless steel care products if recommended in the cleaning instructions for the relevant part.

Using oven cleaner in a hot cooking compartment damages the enamel.

- ▶ Never use oven cleaner in the cooking compartment when it is still warm.
- ▶ Remove all food remnants from the cooking compartment and the appliance door before you next heat up the appliance.

Salt contained in new sponge cloths may damage surfaces.

- ▶ Wash new sponge cloths thoroughly before use.

12.2 Suitable cleaning agents

Only use cleaning agents that are suitable for the different surfaces on your appliance.

Appliance exterior

Follow the instructions on cleaning the appliance.

Area	Suitable cleaning agents	Information
Stainless steel front	<ul style="list-style-type: none"> ■ Hot soapy water ■ Special stainless steel cleaning products suitable for hot surfaces 	To prevent corrosion on stainless steel fronts, remove any limescale, grease, starch and albumin (e.g. egg white) stains immediately. Apply a thin layer of the stainless steel cleaning product.
Control panel	Hot soapy water	Clean with a dishcloth and dry with a soft cloth. Do not use glass cleaner or a glass scraper.
Door panels	Hot soapy water	Clean with a dishcloth and dry with a soft cloth. Do not use a glass scraper or steel wool.
Door handle	Hot soapy water	Clean with a dishcloth and dry with a soft cloth. To avoid permanent stains, remove descaling agents from the door handle immediately.

Appliance interior

Area	Suitable cleaning agents	Information
Enamel surfaces	<ul style="list-style-type: none"> ■ Hot soapy water ■ Vinegar solution ■ Oven cleaner 	<p>Clean with a dishcloth and dry with a soft cloth. Soften burnt-on food residues with a damp cloth and soapy water.</p> <p>If there are heavy deposits of dirt, use a stainless steel scouring pad or oven cleaner. Leave the cooking compartment open to dry after cleaning.</p> <p>Tip: It is best to use the cleaning function. → "Cleaning function", Page 18</p> <p>Note: Food residues may cause white deposits to form. The deposits are not a risk to health and do not affect how the appliance works. You can remove the deposits with lemon juice.</p>

Area	Suitable cleaning agents	Information
Glass cover for the interior lighting	<ul style="list-style-type: none"> ■ Hot soapy water ■ Oven cleaner 	Clean with a dishcloth and dry with a soft cloth. Use oven cleaner to remove very heavy soiling.
Door panels	Hot soapy water	Clean with a dishcloth and dry with a soft cloth. Do not use a glass scraper or steel wool. Tip: It is best to clean the door panels together with the cooking compartment. → "Easy Clean cleaning aid", Page 18
Door seal	Hot soapy water	Clean with a dishcloth. Do not remove or scrub the door seal.
Stainless steel door cover	Stainless steel cleaner	Follow the manufacturers' instructions. Do not use glass cleaner or a glass scraper. Do not use stainless steel care products. Tip: It is best to remove the door cover.
Plastic door cover	Hot soapy water	Do not use glass cleaner or a glass scraper. Do not use stainless steel care products. Tip: It is best to remove the door cover.
Rails	Hot soapy water	Soak and clean using a dishcloth or brush.
Pull-out system	Hot soapy water	Clean with a dishcloth or brush. Clean the pull-out rails while they are pushed in so that you do not remove the lubricant. Do not clean in the dishwasher.
Accessories	Hot soapy water	Soak and clean using a dishcloth or brush. If the accessory is heavily soiled, clean it with steel wool. Tip: You can clean enamelled accessories in the dishwasher.

Notes

- Slight differences in colour on the front of the appliance are caused by the use of different materials, such as glass, plastic and metal.
- Shadows on the door panels, which look like streaks, are caused by reflections made by the interior lighting.
- Enamel is baked on at very high temperatures. This may cause some slight colour variation. The colour differences are normal and do not affect the functionality. The edges of thin trays cannot be completely enamelled and may therefore be rough. This does not impair the corrosion protection.

12.3 Cleaning the appliance

Clean the appliance as specified. This will ensure that the different parts and surfaces of the appliance are not damaged by incorrect cleaning or unsuitable cleaning products.

WARNING – Risk of burns!

The appliance and its parts that can be touched become hot during use.

- ▶ Caution should be exercised here in order to avoid touching heating elements.
- ▶ Young children under 8 years of age must be kept away from the appliance.

WARNING – Risk of fire!

Loose food remnants, fat and meat juices may catch fire.

- ▶ Before using the appliance, remove the worst of the food residues and remnants from the cooking compartment, heating elements and accessories.

Requirement: Read the information on cleaning products.

→ "Cleaning products", Page 16

1. Clean the appliance using hot soapy water and a dish cloth.
For some surfaces, you can use alternative cleaning agents.
→ "Suitable cleaning agents", Page 16
2. Dry with a soft cloth.

Tips

- If you clean the cooking compartment after each use, dirt cannot burn on.
- Always remove limescale, grease, starch or albumin stains immediately.

Note: Use the universal pan for baking very moist cakes.

Tip: To keep the cooking compartment clean, use suitable ovenware for roasting, e.g. a roasting dish.

12.4 Replacing the cooking compartment bulb

If the cooking compartment light has failed, replace the cooking compartment bulb.

Note: Heat-resistant, 230 V, 40 W, G9 halogen bulbs are available from customer service or specialist retailers. Only use these bulbs. Hold the new halogen bulbs only with a clean, dry towel. This increases the service life of the bulb.

⚠ WARNING – Risk of burns!

The appliance and its parts that can be touched become hot during use.

- ▶ Caution should be exercised here in order to avoid touching heating elements.
- ▶ Young children under 8 years of age must be kept away from the appliance.

⚠ WARNING – Risk of electric shock!

When changing the bulb, the bulb socket contacts are live.

- ▶ Before replacing the bulb, ensure that the appliance is switched off in order to prevent a potential electric shock.
- ▶ Also unplug the appliance from the mains or switch off the circuit breaker in the fuse box.

Requirements

- The fuse has been switched off.
- The cooking compartment has cooled down.
- You must have a new halogen lamp to replace the old one.

1. Open the appliance door.
2. Place a tea towel in the cooking compartment to prevent damage.
3. Remove the accessories from the cooking compartment and remove the shelves. → Page 20
4. Remove the glass cover.
If the glass cover is difficult to remove by hand, use a spoon to help you.
5. Pull out the cooking compartment bulb.

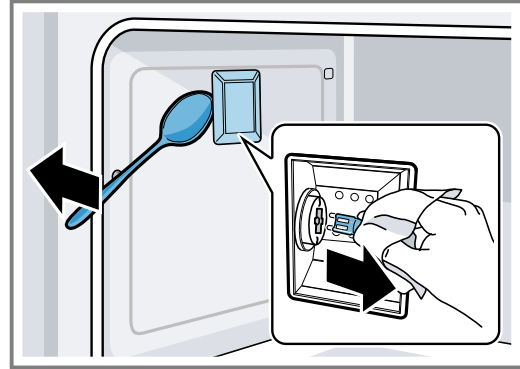

6. Replace the cooking compartment bulb with one of the same type.
7. Refit the glass cover for the oven light bulb.
8. Install the rails. → Page 20
9. Remove the tea towel again.
10. Switch on the fuse again.
11. Check that the oven lighting is working again.

13 Cleaning function

Use the cleaning function to clean your appliance.

13.1 Easy Clean cleaning aid

The cleaning aid is a quick alternative for occasionally cleaning the cooking compartment. The cleaning aid softens dirt by vaporising the soapy water. It is then easier to remove dirt.



Setting Easy Clean

⚠ WARNING – Risk of scalding!

If there is water in the cooking compartment when it is hot, this may create hot steam.

- ▶ Never pour water into the cooking compartment when the cooking compartment is hot.

Requirement: The cooking compartment has cooled down completely.

1. Remove the accessory from the cooking compartment.
2. Mix 0.4 litres non-distilled water with a drop of washing-up liquid.
3. Pour the mixture into the centre of the cooking compartment floor.
4. Use the function selector to select .
5. Use > and < to select **Easy Clean** .

- ✓ The cleaning aid starts after a few seconds.
 - ✓ The duration counts down on the display. The duration is preset. You cannot change the duration.
 - ✓ A signal tone sounds once the cleaning aid time has elapsed.
6. While cleaning, check that the water that is condensed in the drip trough below the appliance door does not overflow.
 - If required, mop up the liquid with a sponge.

Note: If  flashes on the display when the cleaning aid is switched on, this indicates that the cooking compartment has not completely cooled down. Switch off the appliance. Wait until the appliance has cooled down. Switch the cleaning aid on again.

Post-cleaning the cooking compartment

ATTENTION!

The prolonged presence of moisture in the cooking compartment leads to corrosion.

- ▶ After using the cleaning assistance, wipe the cooking compartment and allow it to dry completely.
1. Open the appliance door.

2. Remove the remaining water with an absorbent sponge cloth.
3. Clean the smooth surfaces in the cooking compartment with a dish cloth or a soft brush. Stubborn residues can be removed using a stainless steel scouring pad.
4. Remove limescale with a cloth soaked in vinegar. Then wipe with clean water and rub dry with a soft cloth (including under the door seal).
5. To switch off the appliance, turn the function selector to the off position.
6. Leave the appliance door ajar in the stop position (approx. 30°) for approx. one hour to allow the enamel surfaces in the cooking compartment to dry thoroughly.

Removing heavy deposits of dirt

You have several options for removing particularly stubborn deposits of dirt.

1. Leave the soapy water to work for some time before starting the cleaning aid.
2. Rub soapy water onto the dirt on the smooth surfaces before starting the cleaning aid.
3. Repeat the cleaning aid once the cooking compartment has cooled.

13.2 Pyrolytic self-cleaning

You can use the pyrolytic self-cleaning mode to effortlessly clean the cooking compartment. The cooking compartment is heated up to a very high temperature. Food remnants from roasting, grilling and baking will burn.

WARNING – Risk of serious harm to health!

The appliance gets very hot when the cleaning function is in progress. The non-stick coating on baking trays and tins is destroyed and noxious gases are released.

- ▶ Never clean non-stick baking trays or baking tins using the cleaning function.
- ▶ Only clean enamelled accessories at the same time.

Depending on the duration, cleaning requires approx. 5-10 kW/h. You can set the cleaning duration between 2 hours 30 minutes and 3 hours 30 minutes.

Note: For your safety, the appliance door locks automatically. The appliance door cannot be opened again until the lock indicator light  goes out. The interior lighting remains off while the appliance is being cleaned.

Preparing the appliance for the cleaning function

To achieve a good cleaning result and prevent damage, prepare the appliance carefully.

WARNING – Risk of fire!

Combustible objects that are left in the cooking compartment may catch fire.

- ▶ Never store combustible objects in the cooking compartment.
- ▶ If smoke is emitted, the appliance must be switched off or the plug must be pulled out and the door must be held closed in order to stifle any flames.

Loose food remnants, fat and meat juices may catch fire when the cleaning function is in progress.

- ▶ Before you start the cleaning function, always remove coarse dirt from the cooking compartment.
- ▶ Never clean accessories at the same time.

The outside of the appliance gets very hot when the cleaning function is in progress.

- ▶ Never hang combustible objects, e.g. tea towels, on the door handle.
- ▶ Leave the front of the appliance clear.
- ▶ Keep children at a safe distance.

If the door seal is damaged, a large amount of heat is generated around the door.

- ▶ Do not scrub or remove the seal.
- ▶ Never operate the appliance if the seal is damaged or missing.

1. Remove the shelf supports and pull-out rails from the cooking compartment.
2. Remove coarse dirt from the cooking compartment.
3. Clean the inside of the appliance door and along the edges of the cooking compartment in the area around the seal. Do not scrub the seal.

Setting the cleaning function

Ventilate the kitchen while the cleaning function is running.

WARNING – Risk of harm to health!

The cleaning function heats up the cooking compartment to a very high temperature so that food left over from roasting, grilling and baking will burn off. This process releases vapours, which can irritate mucous membranes.

- ▶ Keep the kitchen well ventilated while the cleaning function is running.
- ▶ Do not remain in the room for long periods.
- ▶ Keep children and pets away.



WARNING – Risk of burns!

The cooking compartment gets very hot when the cleaning function is in progress.



- ▶ Never open the appliance door.
- ▶ Allow the appliance to cool down.
- ▶ Keep children at a safe distance.

 The outside of the appliance gets very hot when the cleaning function is in progress.

- ▶ Never touch the appliance door.
- ▶ Allow the appliance to cool down.
- ▶ Keep children at a safe distance.

1. Use the function selector to set .
2. Use < and > to select the pyrolytic self-clean function .
3. Use the temperature selector to set a cleaning level.

Cleaning level	Duration in h
1	2:30
2	3
3	3:30

- ✓ One minute after the cleaning cycle for the pyrolytic self-cleaning begins, the appliance door is locked to prevent it from being opened. The indicator light  shows the activation of this door opening mechanism. Once the door lock has been activated, you can no longer select any functions. Wait until the  indicator light goes out.

Notes

- If you do not want to end the pyrolytic self-cleaning early, do not change the function selector during the cleaning cycle.
- You will not be able to use the interior lighting while the pyrolytic self-cleaning programme is in progress.

Tip: You cannot use the timer while the pyrolytic self-cleaning programme is in progress. The duration has no effect on the pyrolytic self-cleaning function.

Cancelling the cleaning function

- ▶ Turn the function selector to the off position.

Preparing the appliance for operation after the cleaning function

Requirements

- Once the self-cleaning function has run through to the end, a signal tone sounds.
 - If  goes out on the display, you can open the appliance door.
1. Allow the appliance to cool down.
 2. Wipe off any ash that has been left behind in the cooking compartment, on the shelf supports and around the appliance door with a damp cloth.

Note: White residues on the enamel surfaces may be caused by heavy soiling. These food residues are harmless. The deposits do not compromise the functionality of the appliance. You can remove these residues using lemon juice if required.

14 Rails

To thoroughly clean the rails and the cooking compartment, or to replace the rails, you can remove the rails.

14.1 Detaching the rails

The rails are each fixed to the side panels of the cooking compartment at 3 points.

1. Grip the front of the rail and pull it round to the middle of the cooking compartment.
- ✓ The front hook of the rail comes out of the hole.

2. Swing the rail round further and pull it out of the rear holes in the side panel.

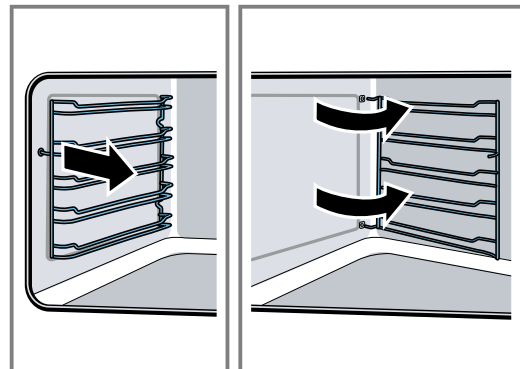

3. Remove the rail from the cooking compartment.

14.2 Attaching the rails

1. Insert the hooks of the rail into the rear holes in the side panel.
2. Push the front hook of the rail into the hole.

15 Appliance door

With good care and cleaning, your appliance retains its appearance and remains fully functioning for a long time to come. This will tell you how to clean the appliance door.

Note: To ensure that the appliance door does not come into contact with the fitted unit, the appliance door opens slightly less than 90°.

15.1 Removing the door panels

To facilitate cleaning, you can remove the glass panels from the appliance door.

⚠ WARNING – Risk of injury!

Scratched glass in the appliance door may develop into a crack.

- ▶ Do not use any harsh or abrasive cleaners or sharp metal scrapers to clean the glass on the oven door, as they may scratch the surface.

1. Open the appliance door fully.
2. Use the security pins to lock the left- and right-hand hinges.

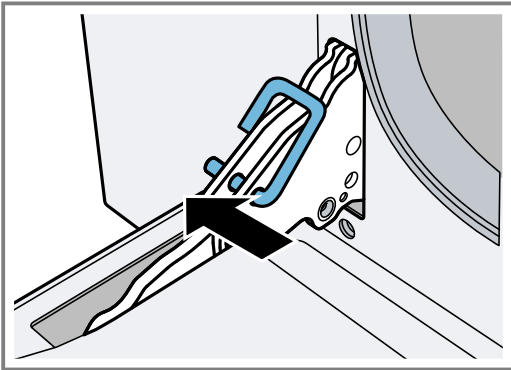

The locking pins must be fully inserted into the holes in the hinges.

3. Use both hands to lift the lower section of the inner panel until the fastening pins come out of the holder. ①
4. To completely loosen the inner panel from the door, carefully pull the upper section of the inner panel out of the profile and lift it.

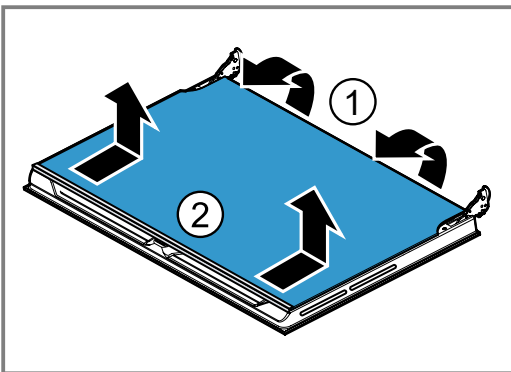

5. Lift out the inner panel and set it down carefully on a flat surface.

6. Remove the two intermediate panels and their holders.

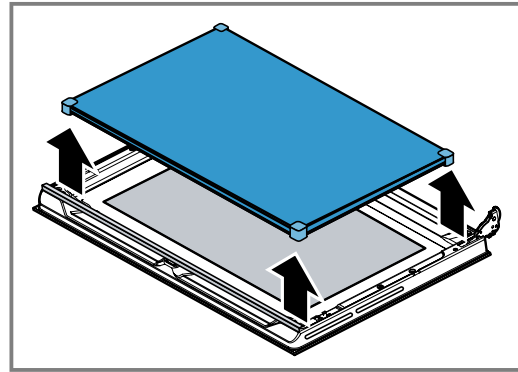

The two intermediate panels are not fastened using retaining pins; instead, they are held in place using holders.

7. To separate the two intermediate panels from each other, remove the holders.
8. Clean the door panels with glass cleaner and a soft cloth.

15.2 Fitting the door panels

1. Insert the two intermediate panels.
 - Ensure that the intermediate panel is seated correctly.
 - ✓ All holders must lay flat against the outer panel.
 - ✓ If the Low-E symbol can be read on both intermediate panels, both of the intermediate panels have been inserted correctly.
2. Insert the inner panel.
 - Insert the inner panel into the profile first. The two fastening pins must then engage in the holders provided for them.
3. Remove the locking pins and close the appliance door.

Note: Do not throw away the locking pins. Store the locking pins in a secure location. You always require the locking pins when you remove the door or door panels from the appliance. If you do not have any locking pins, you can order these from customer service.

15.3 Detaching the appliance door

If it is particularly dirty, you can remove the appliance door to clean it more thoroughly.

1. Open the appliance door fully.
2. Use the security pins to lock the left- and right-hand hinges.
 - The locking pins must be fully inserted into the holes in the hinges.

3. Grip the appliance door on either side with both hands and close it by approx. 30 degrees.

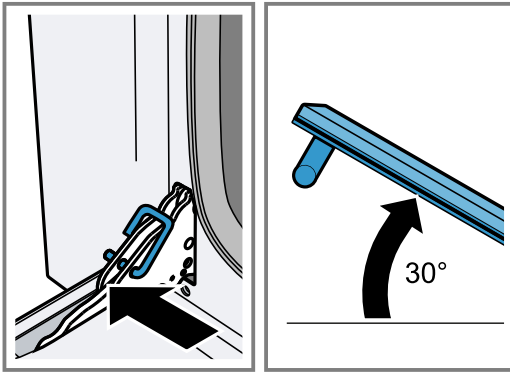

Do not close the appliance door fully. The hinges could become bent and the enamel could be damaged.

4. Lift the appliance slightly and pull it out completely.

15.4 Attaching the appliance door

⚠ WARNING – Risk of injury!

If the hinges are not secured due to an incomplete lock, they can snap shut with great force.

- ▶ If the hinge snaps shut when detaching or attaching the appliance door, do not reach into the hinge.
- ▶ Call customer service.

If a door pane or appliance door has not been installed correctly, this is dangerous.

- ▶ Make sure that all of the door panes and the appliance door have been correctly fitted before you switch the appliance back on again.

1. Grip the appliance door on either side with both hands.
2. Slide the hinges into the slots in the appliance.

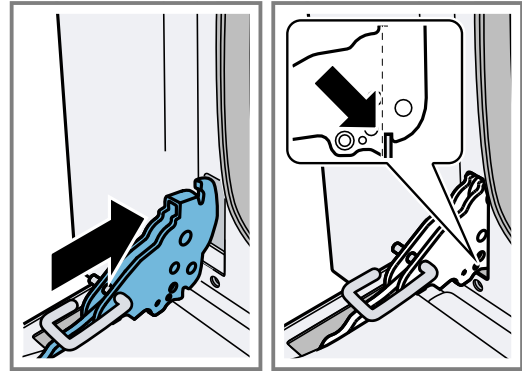

The notch below the hinges must engage into the frame of the appliance.

3. Lower the appliance door downwards.
4. Remove the locking pins.

Note: Do not throw away the locking pins. Store the locking pins in a secure location. You always require the locking pins when you remove the door or door panels from the appliance. If you do not have any locking pins, you can order these from customer service.

16 Troubleshooting

You can rectify minor faults on your appliance yourself. Read the troubleshooting information before contacting after-sales service. This will avoid unnecessary costs.

⚠ WARNING – Risk of injury!

Improper repairs are dangerous.

- ▶ Repairs to the appliance should only be carried out by trained specialist staff.
- ▶ If the appliance is defective, call Customer Service.
→ "Customer Service", Page 24

⚠ WARNING – Risk of electric shock!

Improper repairs are dangerous.

- ▶ Repairs to the appliance should only be carried out by trained specialist staff.
- ▶ Only use genuine spare parts when repairing the appliance.
- ▶ If the power cord of this appliance is damaged, it must be replaced by the manufacturer, the manufacturer's Customer Service or a similarly qualified person in order to prevent any risk.

16.1 Malfunctions

Fault	Cause and troubleshooting
The appliance is not working.	The mains plug of the power cord is not plugged in. ▶ Connect the appliance to the power supply.
	There has been a power cut. ▶ Check whether the lighting in your room or other appliances are working.
	The circuit breaker in the fuse box has tripped. ▶ Check the circuit breaker in the fuse box.
The appliance does not start.	The appliance door is not fully closed. ▶ Close the appliance door.

Fault	Cause and troubleshooting
The appliance does not start.	The appliance is not switched off. <ul style="list-style-type: none"> ▶ Switch the appliance off and then on again.
12:00 flashes on the display.	There has been a power cut. <ul style="list-style-type: none"> ▶ Set the time. → <i>"Before using for the first time", Page 10</i>
The interior lighting does not work.	"Top/bottom heating gentle" mode is activated. <ul style="list-style-type: none"> ▶ In this operating mode, the interior lighting is switched off. <hr/> The cooking compartment bulb is defective. <ul style="list-style-type: none"> ▶ Change the cooking compartment bulb. → <i>"Replacing the cooking compartment bulb", Page 18</i>
Dishes that are cooked in the oven burn in a short time.	The thermostat is faulty. <ul style="list-style-type: none"> ▶ Call → <i>"Customer Service", Page 24.</i>
Door panels are steamed up.	Normal occurrence caused by temperature differences. <ul style="list-style-type: none"> ▶ Heat the appliance up to 100 °C and switch the appliance off after 5 minutes.
The appliance is switched on but cannot be operated. ↻ lights up on the display.	The child safety lock is activated. <ul style="list-style-type: none"> ▶ Deactivate the child safety lock. → <i>"Deactivating the child safety lock", Page 14</i>
The display has frozen or does not respond.	The child safety lock is activated. <ul style="list-style-type: none"> ▶ Deactivate the child safety lock. → <i>"Deactivating the child safety lock", Page 14</i> <hr/> Malfunction <ol style="list-style-type: none"> 1. Switch off the fuse in the fuse box. 2. Switch the fuse on after approx. 10 seconds. 3. If the malfunction occurs again, call customer service.
The appliance door cannot be opened. 🔒 lights up on the display.	The appliance door remains locked until the cooking compartment has cooled down. <ul style="list-style-type: none"> ▶ Wait until the cooking compartment has cooled and 🔒 goes out.
The door panels feel warmer than before after the door panels have been removed for cleaning.	The door panels have been inserted the wrong way round. <ul style="list-style-type: none"> ▶ Check whether the door panels have been inserted correctly. → <i>"Fitting the door panels", Page 21</i>
The cooling fan continues to run after operation.	Not a fault. The cooling fan continues to run until the temperature that is selected in the basic settings has been reached. → <i>"Basic settings", Page 15</i>
Condensation water on the appliance door or condensation water is dripping.	The appliance door does not close correctly. <ul style="list-style-type: none"> ▶ Check whether the appliance door is installed correctly and closes correctly. → <i>"Appliance door", Page 20</i> <hr/> Dirt on the seal. <ol style="list-style-type: none"> 1. Check whether the seal is dirty, damaged or seated incorrectly. 2. Clean or replace the seal, or ensure that it is seated correctly. <hr/> Normal condensation. → <i>"Condensation", Page 8</i>

Fault	Cause and troubleshooting
A message with \bar{E} appears on the display.	Malfunction ▶ Set the function selector to the off position. If the error message does not disappear, contact customer service.

17 Disposal

17.1 Disposing of old appliance

Valuable raw materials can be reused by recycling.

- ▶ Dispose of the appliance in an environmentally friendly manner. Information about current disposal methods are available from your specialist dealer or local authority.



This appliance is labelled in accordance with European Directive 2012/19/EU concerning used electrical and electronic appliances (waste electrical and electronic equipment - WEEE). The guideline determines the framework for the return and recycling of used appliances as applicable throughout the EU.

18 Customer Service

Function-relevant genuine spare parts according to the corresponding Ecodesign Order can be obtained from Customer Service for a period of at least 10 years from the date on which your appliance was placed on the market within the European Economic Area.

Note: Under the terms of the manufacturer's warranty the use of Customer Service is free of charge.

Detailed information on the warranty period and terms of warranty in your country is available from our after-sales service, your retailer or on our website.

If you contact Customer Service, you will require the product number (E-Nr.) and the production number (FD) of your appliance.

The contact details for Customer Service can be found in the enclosed Customer Service directory or on our website.

This product contains light sources from energy efficiency class G.

18.1 Product number (E-Nr.) and production number (FD)

You can find the product number (E-Nr.) and the production number (FD) on the appliance's rating plate. You will see the rating plate with these numbers if you open the appliance door.

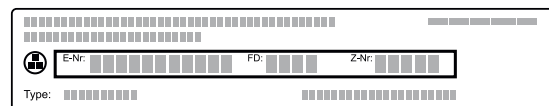

Make a note of your appliance's details and the Customer Service telephone number to find them again quickly.

19 How it works

You can find a selection of tips about cookware and preparing meals here.

19.1 What is the best way to proceed?

ATTENTION!

Acidic food may damage the grid

- ▶ Do not place acidic food, such as fruit or food with an acidic marinade directly on the pan support.

Note: Information for those allergic to nickel

In rare cases, small amounts of nickel may pass into the food.

1. Before using the appliance, remove all unnecessary cookware from the cooking compartment.
2. Select the desired food from the recommended settings.
3. Place the food in suitable cookware.

Use the accessory provided.

4. Only preheat the appliance if the recipe or the recommended settings tell you to do so. Do not line the accessory with greaseproof paper until after it has been preheated.
5. Set the appliance in accordance with the recommended settings. Set the shorter cooking time first. If required, increase the duration.
6. Always keep the appliance door closed when cooking.

19.2 Baking tips

We have compiled a few tips to help you achieve a good baking result.

Issue	Tip
You want your cake to rise evenly.	<ul style="list-style-type: none"> ■ Only grease the base of the springform cake tin. ■ After baking, use a knife to carefully loosen the cake from the baking tin.
You do not want small baked items to stick to each other when baking.	Leave a minimum clearance of 2 cm around each item to be baked. This allows enough space for the baked items to expand and brown on all sides.

Issue	Tip
Determine whether the cake is ready.	Push a cocktail stick into the highest point on the cake. If no dough sticks to the wood, the cake is ready.
You want to bake using your own recipe.	Use similar items in the baking tables as a guide.
Use bakeware made of silicone, glass, plastic or ceramic.	<ul style="list-style-type: none"> ■ The bakeware must be heat-resistant up to 250 °C. ■ Cakes in this bakeware brown less.













19.3 Food table

You can find an overview of the food here.

Food	Weight in kg	Shelf position	Type of heating	Temperature in °C/grill setting	Duration in mins
Lasagne	3 – 4	1	≡	220 – 230 ¹	45 – 50
Pasta bake	3 – 4	1	≡	220 – 230 ¹	45 – 50
Joint of veal	2	2	⌘	180 – 190 ¹	90 – 100
Joint of veal	2	2	≡	200 ²	120
Pork loin	1.5	2	⌘	190 – 200 ¹	90 – 100
Pork loin	2	2	≡	200 ²	130
Sausages	1.5	3	⌘	280 ¹	1st side: 10 2nd side: 5
Roast beef	1	2	⌘	200 ¹	40 – 45
Roast rabbit	1.5	2	⌘	180 – 190 ¹	70 – 80
Turkey breast	2	2	⌘	180 – 190 ¹	110 – 120
Pork neck joint	2 – 3	2	⌘	180 – 190 ¹	170 – 180
Roast chicken	1.2	2	⌘	180 – 190 ¹	65 – 70
Pork chops	1.5	4	⌘	280 ¹	1st side: 15 2nd side: 5
Spare ribs	1.5	4	⌘	280 ¹	1st side: 15 2nd side: 10
Bacon	0.7	5	≡	Int ¹	1st side: 10 2nd side: 8
Fillet of pork	1.5	4	⌘	280 ¹	1st side: 12 2nd side: 5
Fillet of beef	1	5	≡	Int ¹	1st side: 10 2nd side: 7
Rainbow trout	1.2	2	⌘	150 – 160 ¹	35 – 40
Monkfish	1.5	2	⌘	160 ¹	60 – 65
Turbot	1.5	2	⌘	160 ¹	45 – 50

¹ Preheat the appliance.

² Do not preheat the appliance.

Food	Weight in kg	Shelf position	Type of heating	Temperature in °C/grill setting	Duration in mins
Pizza	1	1		280 ¹	8 – 9
Bread	1	2		190 – 200 ¹	25 – 30
Focaccia	1	2		180 – 190 ¹	20 – 25
Bundt cake	1	2		160 ¹	55 – 60
Fruit pie	1	2		160 ¹	35 – 40
Cheesecake	1	2		160 – 170 ¹	45 – 55
Short-crust pastry	1	2		160 – 170 ¹	35 – 40
Short-crust pastry	1	1		170 ²	65
Parfait cake	1.2	2		160 ¹	55 – 60
Cream puffs	1.2	2		180 ¹	80 – 90
Sponge cake	1	2		150 – 160 ¹	55 – 60
Rice pudding	1	2		160 ¹	55 – 60
Brioche	1.2	2		160 ¹	30 – 35

¹ Preheat the appliance.

² Do not preheat the appliance.

19.4 Tips for next time you bake

If something goes wrong when baking, you can find some tips here.

Issue	Tip
Your cake collapses.	<ul style="list-style-type: none"> ■ Note the ingredients and preparation instructions that are given in the recipe. ■ Use less liquid. Or: ■ Reduce the baking temperature by 10 °C and increase the baking time.
Your cake is too dry.	Increase the baking temperature by 10 °C and shorten the baking time.
Your cake is generally too light in colour.	<ul style="list-style-type: none"> ■ Check the shelf position and accessory. ■ Increase the baking temperature by 10 °C. Or: ■ Increase the baking time.
Your whole cake is too dark.	Reduce the baking temperature and increase the baking time.
Your cake is too light on top and too dark underneath.	Place the cake one level higher in the cooking compartment.

Issue	Tip
Your cake is too dark on top and too light underneath.	<ul style="list-style-type: none"> ■ Place the cake one level lower in the cooking compartment. ■ Reduce the baking temperature and increase the baking time
Your cake is unevenly browned.	<ul style="list-style-type: none"> ■ Reduce the baking temperature. ■ Cut the greaseproof paper to a suitable size. ■ Position the baking tin in the centre. ■ Shape small baked goods to be the same size and thickness.

Issue	Tip
Your cake is cooked on the outside but is not fully baked through on the inside.	<ul style="list-style-type: none"> Reduce the baking temperature and increase the baking time. Add less liquid. <p>For cakes with a moist topping:</p> <ul style="list-style-type: none"> Pre-bake the base. Sprinkle the baked base with almonds or breadcrumbs. Place the topping on the base.
The cake will not come out of the tin when turned upside down.	<ul style="list-style-type: none"> Allow the cake to cool for 5 - 10 minutes after baking. Use a knife to carefully loosen the edge of the cake. Turn the cake tin upside down again and cover it several times with a cold, wet cloth. Next time you bake, grease the baking tin/dish and sprinkle it with breadcrumbs.

19.5 Tips for next time you roast

If roasting is not successful the first time, you can find some tips here.

Issue	Tip
Your roast is too dark and the crackling is partly burnt.	<ul style="list-style-type: none"> Select a lower temperature. Reduce the roasting time.

19.6 Test dishes

These overviews have been produced for test institutes to facilitate appliance testing in accordance with EN 60350-1.

Baking

Food	Accessories	Shelf position	Type of heating	Temperature in °C	Duration in mins
Shortbread strips	Universal pan with greaseproof paper	2		160 ¹	26

¹ Preheat the appliance.

Issue	Tip
Your roast is too dry.	<ul style="list-style-type: none"> Select a lower temperature. Reduce the roasting time.
The crackling on your roast is too thin.	<ul style="list-style-type: none"> Increase the temperature. <p>Or:</p> <ul style="list-style-type: none"> Switch on the grill briefly at the end of the roasting time.
Your roasting juices are burnt.	<ul style="list-style-type: none"> Select a smaller item of cookware. When roasting, add more liquid.
Your roasting juices are too clear and watery.	<ul style="list-style-type: none"> Use a larger item of cookware so that more liquid evaporates. When roasting, add less liquid.
The meat catches during braising.	<ul style="list-style-type: none"> Check whether the roasting dish and lid fit together and close properly. Reduce the temperature. Add liquid when braising.
Your roast is not well-done enough.	<ul style="list-style-type: none"> Carve the meat into portions. Prepare the juices in the roasting dish. Place the sliced meat in the juices. Place the slices of meat in the microwave to finish cooking.

Food	Accessories	Shelf position	Type of heating	Temperature in °C	Duration in mins
Shortbread strips, 2 levels	Universal pan + baking tray with greaseproof paper	2 + 4		160 ¹	26 – 28
Small cakes	Universal pan	2		150 ¹	21 – 23
Small cakes, 2 levels	Universal pan + baking tray	1 + 4		160 ¹	25 – 28
Hot water sponge cake	Springform tin	2		170 ¹	30
Hot water sponge cake, 2 levels	2 x springform cake tins	2 + 4		160 ¹	40 – 45
Double-crust apple pie, 1 pc	Springform tin	2		170 ¹	75
Double-crust apple pie, 2 pcs	2 x springform cake tins	2 + 4		170 ¹	70

¹ Preheat the appliance.

Grilling

Also slide in the universal pan. The universal pan catches the liquid and the cooking compartment stays cleaner.

Food	Accessories	Shelf position	Type of heating	Grill setting	Duration in mins
Bread for toasting	Wire rack	5		Int	5 – 6
Beef burger, 10 pcs, 75 mm diameter	Baking tray + wire rack	4 + 5		Int ¹	1st side: 15 2nd side: 5

¹ Preheat the appliance for at least 12 minutes.

20 Installation instructions



20.1 Safe installation

Follow these instructions before you start installing the appliance.

WARNING – Risk of fire!

It is dangerous to use an extended power cord and non-approved adapters.

- ▶ Do not use multiple socket strips.
- ▶ Only use extension cables that are certified, have a minimum cross section of 1.5 mm² and comply with the applicable national safety requirements.
- ▶ If the power cord is too short and a longer one is not available, please contact an electrician to have the domestic installation adapted.

- ▶ Only use adapters and power cords approved by the manufacturer.

ATTENTION!

Carrying the appliance by the door handle could break it. The door handle cannot support the weight of the appliance.

- ▶ Do not carry or hold the appliance by the door handle.
- The safe operation of this appliance can only be guaranteed if it has been installed to a professional standard in accordance with these installation instructions. The installer shall be liable for damages incurred as a result of incorrect installation.
- Check the appliance for damage after unpacking it. Do not connect the appliance if it has been damaged in transit.
- Before starting up the appliance, remove any packaging material and adhesive film from the cooking compartment and the door.

Secure the worktop to the built-in unit. Observe the installation instructions for the hob.

20.5 Installation in a tall unit

Observe the installation dimensions and the safety clearances in a tall unit.

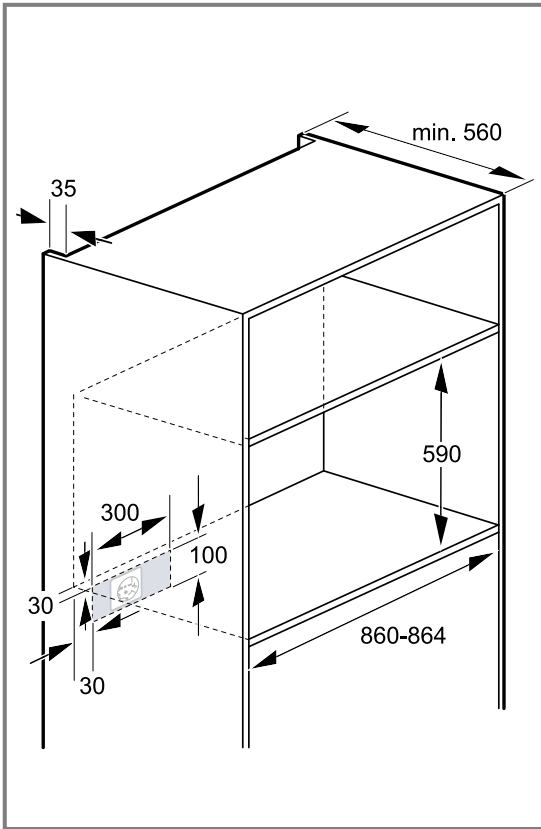

- Ensure that the intermediate floor has a gap to the installation wall in order to ventilate the appliance.
- If the tall unit has another back panel in addition to the element back panels, this must be removed.
- Only fit the appliance up to a height which allows accessories to be easily removed.

20.6 Installing two appliances on top of each other

Your appliance can also be installed above another appliance.

20.7 Electrical connection

In order to safely connect the appliance to the electrical system, follow these instructions.

- The fuse protection must correspond to the power rating specified on the appliance's rating plate and to local regulations.
- The appliance corresponds to protection class I and must only be operated with a protective earth connection.
- The appliance must be disconnected from the power supply whenever installation work is being carried out.
- Contact protection must be ensured by the installation.
- Only a licensed professional may connect appliances without plugs. They are subject to the requirements of the local electricity provider.

Electrically connecting an appliance without a protective contact plug

Note: Only licensed specialists may connect the appliance. Damage caused by incorrect connection is not covered under the warranty.

An isolating switch must be integrated into the permanent electrical installation according to the installation regulations.

1. Identify the phase and neutral conductors in the socket.
The appliance may be damaged if it is not connected correctly.
2. Only connect the appliance to a mains voltage between 220 und 240 V.
3. Connect the wires of the mains power cable according to the colour coding:
 - Green/yellow = Conductor ⊕
 - Blue = Neutral conductor
 - Brown = Phase (external conductor)

Appliance connected loads

You can select a different connection depending on the appliance model. In this case, you must connect the appliance on the rear of the appliance using the power cord in accordance with the connection diagram. Ensure that the power cord corresponds to H05VV-F or higher. Determine which wire cross section you require in accordance with the current load. If required, install copper bridges. Incorrect connections may damage the appliance.

Appliance connected load	Min. fuse protection at 1~	Min. fuse protection at 2/3 N~
3.3 kW	16 A	
4.2 kW	20 A	12 A

20.8 Installing the appliance

1. Slide the appliance and centre it.

2. Do not kink the connection cable.
2. Open the oven door completely.

3. Remove the cover.

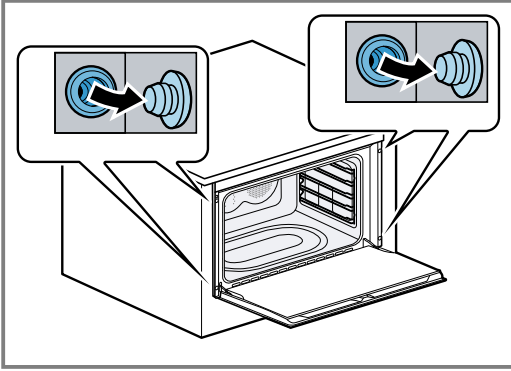

4. Screw the appliance tightly onto the unit.

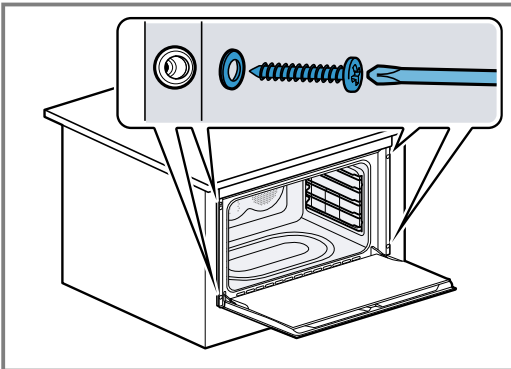

5. Put the protective cover on.

Note: Never close the gap between the worktop and the appliance using additional battens.

20.9 Removing the appliance

1. Disconnect the appliance from the power supply.
2. Undo the fastening screws.
3. Lift the appliance slightly and pull it out completely.

Valid within Great Britain:
Imported to Great Britain by
BSH Home Appliances Ltd.
Grand Union House
Old Wolverton Road
Wolverton, Milton Keynes
MK12 5PT
United Kingdom



Register your product online
neff-home.com

BSH Hausgeräte GmbH
Carl-Wery-Straße 34
81739 München, GERMANY



9001867888
030620
en

