



Westinghouse

User Manual

WSD27HWA

WSD36HWA

WSD51HWA

WSD73HWA

WSD91HWA

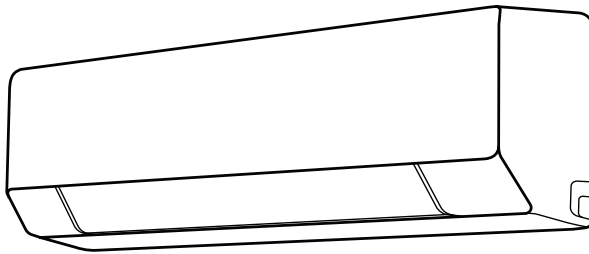

CONTENTS



1. SAFETY INSTRUCTIONS	3
2. PRODUCT DESCRIPTION	5
3. INDOOR UNIT DISPLAY	6
4. REMOTE CONTROLLER	6
5. REMOTE CONTROLLER DESCRIPTION	8
6. HOW TO USE THE REMOTE CONTROLLER	11
7. HOW TO USE THE INDOOR UNIT	16
8. OPERATING TEMPERATURE	17
9. EMERGENCY OPERATION	17
10. CLEANING AND MAINTENANCE	18
11. OPERATION TIPS	20
12. TROUBLESHOOTING	22
13. ENVIRONMENTAL CONCERNS	23

CUSTOMER CARE AND SERVICE

We recommend the use of original spare parts.

When contacting Service, ensure that you have the following data available.

The information can be found on the rating plate. Model, PNC, Serial Number

-  Warning / Caution-Safety information.
-  General information and tips
-  Environmental information.

Subject to change without notice.

R32 refrigerant warning

This product uses R32 difluoromethane refrigerant, which is a mildly flammable gas class 2.2 according according to AS/NZS 5149 and must be handled by a refrigeration mechanic with appropriate Australian refrigerant handling licence.

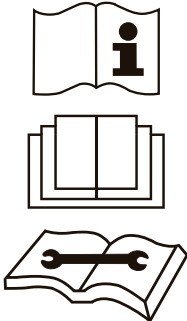

CAUTION: Risk of fire

1. SAFETY INSTRUCTIONS

Before the installation and use of the appliance, carefully read the supplied instructions. The manufacturer is not responsible if an incorrect installation and use causes injuries and damages. Always keep the instructions with the appliance for future reference.

1.1 Children and Vulnerable People Safety



WARNING!

Risk of suffocation, injury or permanent disability.

- This appliance is not intended for use by persons (including children) with reduced physical, sensory or mental capabilities, or lack of experience and knowledge, unless they have been given supervision or instruction concerning use of the appliance by a person responsible for their safety.
- Children should be supervised to ensure that they do not play with the appliance.

1.2 Installation and Use







WARNING!

Risk of suffocation, injury or permanent disability.

- Contact an authorised installer for installation of this unit.
- Contact an authorised service technician for repair or maintenance of this unit.
- The socket outlet required to supply power must be connected and commissioned by a licenced contractor.
- If the supply cord is damaged, it must be replaced by the manufacturer, its service agent or similarly qualified persons in order to avoid a hazard.
- Installation work must be performed in accordance with the national wiring standards and the electricity suppliers service rules by authorised personnel only.
- If the unit is to be moved to another location or disposed of, only a suitable qualified person is permitted to undertake such work.
- If you notice an unusual situation, such as a burning smell, please switch off the power to the air conditioner and contact an Westinghouse service agent. If this abnormal status continues the air conditioner may be damaged or even cause electric shock or fire.
- Do not operate the air conditioner with wet hands. This may cause electric shock.
- Do not damage or cut off the power cord or other wires. If this occurs, please have it repaired or replaced by an accredited technician.
- Do not connect this air conditioner to a multi outlet power board.
- Please switch off the power supply to the air conditioner if it is not to be used for an extended period. Otherwise, it will accumulate dust and may cause a fire.
- Before cleaning the air conditioner, please disconnect the power supply in order to eliminate the possibility of electric shock.
- The power supply should be matched with the air conditioner. Air conditioners provided with a supply cord should be connected directly to a power outlet with a suitable safety switch. Air conditioners that are hard wired must be connected to a suitable safety circuit breaker.
- Please ensure that the power supply to the air conditioner is stable and meets the requirements set out in the installation manual.
- Always ensure the product is installed with appropriate earthing.
- For safety, be sure to turn off the circuit breaker before performing any maintenance or cleaning or when the

product is not used for an extended period of time. Accumulated dust may cause fire or electric shock.

- Select the most appropriate temperature. It can save electricity.
- Do not keep windows and doors open for a long time during operation. It will result in insufficient performance.
- Do not block the air inlet or outlet. It will result in insufficient performance and cause malfunctions.
- Keep combustible materials away from the units at least 1meter. It may cause fire.
- Do not step on the top of the outdoor unit or place heavy things on it. It may cause damage or injury.
- Do not attempt to repair the air conditioner by yourself. Incorrect repairs may cause electric shock or fire. Please contact your local authorised service centre.
- Do not insert your hands or objects into the air inlet or outlet. It may cause injury.
- Do not expose animals or plants directly to the airflow.
- Do not use the unit for any other purpose, such as preserving food or drying clothes.
- Do not splash water on the air conditioner. It may cause electric shock or malfunction.

Symbol	Note	Explanation
	WARNING	This symbol shows that this appliance uses a mildly flammable refrigerant. If the refrigerant is leaked and exposed to an external ignition source, there is a risk of fire.
	CAUTION	This symbol shows that the operation manual should be read carefully.
	CAUTION	This symbol shows that a service personnel should be handling this equipment with reference to the installation manual.
	CAUTION	This symbol shows that information is available such as the operating manual or installation manual.



R32 refrigerant warning

This product uses R32 difluoromethane refrigerant, which is a mildly flammable gas class 2.2 according to ISO 5149 and must be handled by a refrigeration mechanic with appropriate refrigerant handling licence.

1.3 Minimum Floor Areas

This product uses mildly flammable R32 refrigerant. Certain levels of refrigerant require minimum room sizes. Please ensure that these minimum room sizes are adhered to for standard installations.

The appliance must be installed, used and stored in an area that is greater than 6.39m².

2. PRODUCT DESCRIPTION

i All the pictures in this manual are for explanation purposes only. The actual shape of the indoor unit you purchased may be slight different on front panel and display window. The actual shape shall prevail.

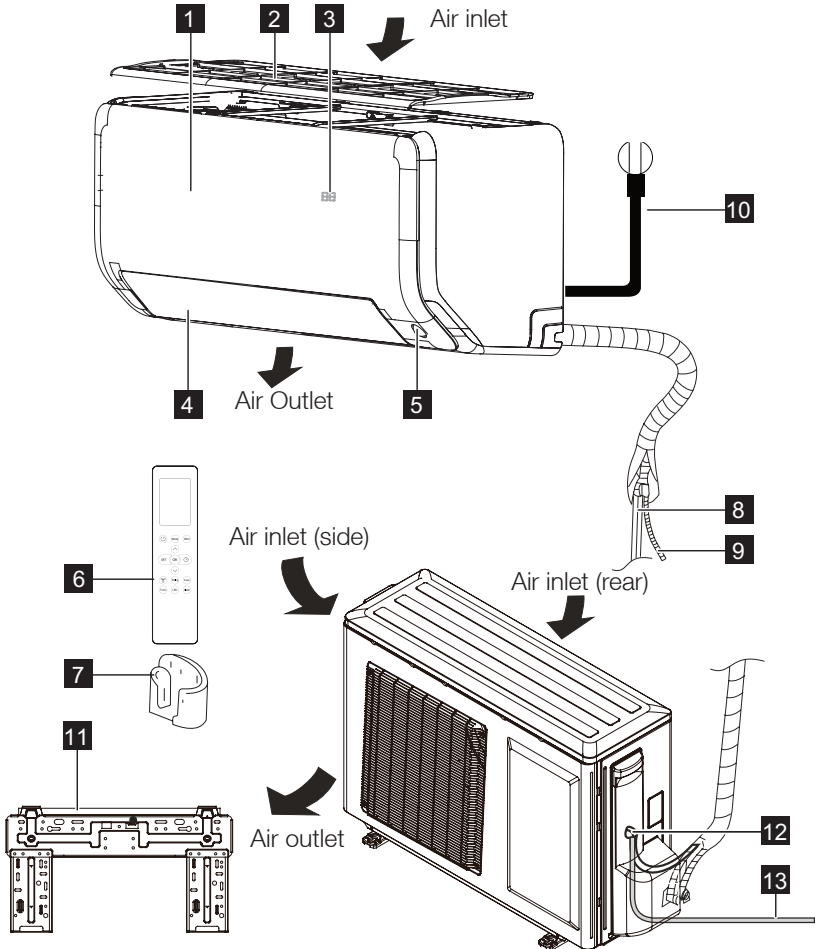

- | | |
|--|--|
| 1 Front panel | 8 Refrigerant pipes |
| 2 Air filter | 9 Drain hose |
| 3 Digital display | 10 Power cable (some units) |
| 4 Louver | 11 Mounting plate (indoor unit) |
| 5 ECO intelligent eye (if applicable) | 12 Connecting cable |
| 6 Remote controller | 13 Power cable (some units) |
| 7 Remote controller Holder (some units) | |

3. INDOOR UNIT DISPLAY

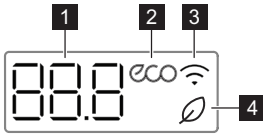

1 TEMPERATURE indication lamp

- Displays the setting or room temperature when the unit is operational.
- Displays the malfunction code when fault occurs.
- Displays the feature when a feature is activated.

2 ECO feature indication lamp

- Lights up when ECO feature is activated.

3 Wireless indication lamp

- Lights up when Wireless feature is activated.

4 Fresh feature indication lamp

- Lights up when Fresh feature is activated.

Feature code in indoor unit display

“ON” Displays for 3 seconds when Timer on is set or the feature Swing, Turbo or Quiet is turned on.

“OF” Displays for 3 seconds when Timer off is set or the feature Swing, Turbo or Quiet is turned off.

“cF” Displays when anti-cold air feature is turned on.

“dF” Displays when unit is in defrosting.

“L” Displays when Self Clean feature is turned on.

“FP” Displays when 8°C heating feature is turned on.

4. REMOTE CONTROLLER

4.1 How to use the Remote Controller

1. Keep the remote controller where its signal can reach the receiver of the indoor unit.
2. When operate the air conditioner, make sure the remote controller is pointing to the signal receiver of the indoor unit.
3. When the remote controller sends out a signal, the symbol  will blink in the display of the remote controller.
4. The indoor unit will acknowledge the signal with a beep sound when it receives the signal from the remote controller.
5. Please press the button of the remote controller and resend the signal if you did not hear a beep sound from the indoor unit.



- The air conditioner will not operate if curtains, doors or other materials block the signals from the remote controller to the indoor unit.
- Prevent any liquid from falling into the remote controller. Do not expose the remote controller to direct sunlight or heat.
- If the infrared signal receiver on the indoor unit is exposed to direct sunlight, the air conditioner may not function properly. Use curtains to prevent the receiver being exposed to sunlight.
- If other electrical appliances react to the remote controller, either move these appliances or consult your local dealer.

4.2 Location of the Remote Controller

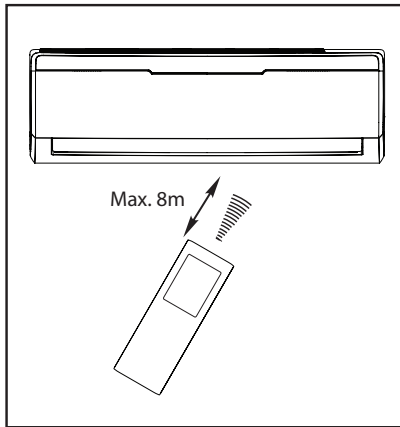

- Keep the remote controller where its signal can reach the receiver of the indoor unit (a maximum distance of 8 m is allowed).
- When the remote controller sends out a signal, the symbol $\hat{\wedge}$ will blink on the display. The indoor unit will acknowledge the signal with a beep sound when it receives an effective signal.

4.3 Battery Installation /Replacement

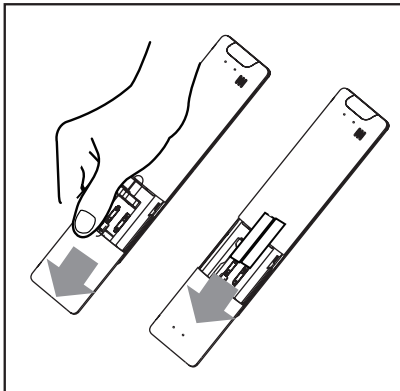

- Remove the back cover from the remote controller, exposing the battery compartment and insert two new alkaline dry batteries (2x AAA 1.5 Volt). Make sure that the polarity of (+) or (-) is installed correctly.
- Slide the battery compartment cover back on.



- When changing batteries, do not use old or varied ones, otherwise, it may cause problems with the remote controller.
- If the remote controller is not used for a long time, remove the batteries as old batteries may leak or corrode and damage the remote controller.
- The battery life during normal use is about six months.
- If the remote controller does not operate normally, please remove and refit the batteries. If abnormal operation continues, replace with new batteries.

5. REMOTE CONTROLLER DESCRIPTION

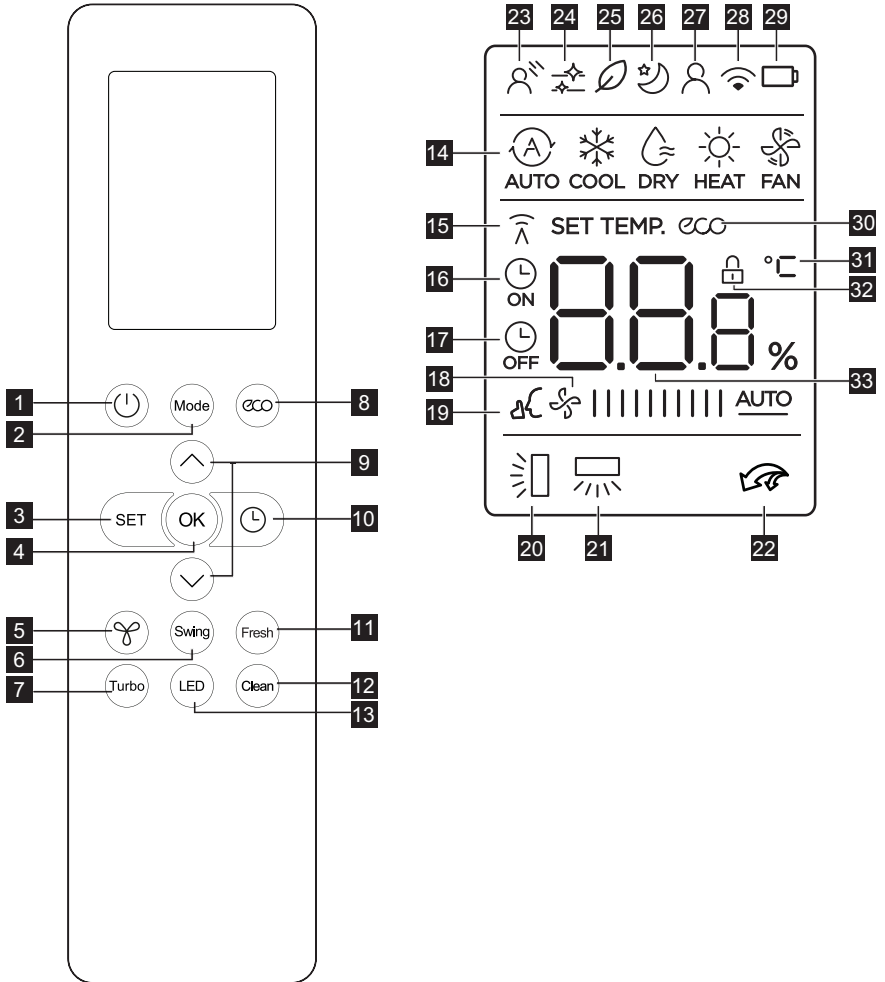

1. ON/OFF BUTTON

Press the button to switch on or off the unit

2. MODE BUTTON

Press the button to set the operation mode: AUTO, COOL, DRY, HEAT and FAN. Default setting: AUTO.



- In AUTO mode, user can still set desired temperature.

3. SET BUTTON

Press the button to select some advance functions.

The select function symbol will flash on the display, press OK button to confirm it.





See section "How to use the remote controller" for the SET function description in details.

4. OK BUTTON

Press the button to confirm the function you have chosen in SET function.

5. FAN BUTTON

Press the button to set the fan speed: AUTO, LOW, MEDIUM and HIGH. Default setting: AUTO. In the AUTO and DRY mode, fan speed can not be set.

Silence		1%-20%
LOW		21%-40%
MED		41%-60%
HIGH		61%-100%
AUTO		

6. SWING BUTTON

Press the button to stop or start vertical louver movement or set the desired horizontal air flow direction.

Press the button more than 2 seconds to stop or start horizontal louver auto swing feature.

Default setting: OFF.

7. TURBO BUTTON

In COOL or HEAT mode, press the button to enable or disable the turbo function.

If the turbo function is enabled, the unit will operate at turbo speed to cool or heat rapidly so that the ambient temperature approaches the set temperature as soon as possible.

8. ECO BUTTON

Press the button to activate the ECO energy efficient mode. Default setting: OFF

9. TEMP BUTTON

Press the button to increase/decrease the temperature. Keep the button pressed for two seconds to accelerate the process.

Temperature range: 16-30°C.

In Timer function, use the button to set the timer adjustment.

10. TIMER BUTTON

Press the button to set the timer function for switching on/off the unit.

See section "How to use the remote controller" for the Timer function description in details.

11. FRESH BUTTON

Press the button to enable/disable the fresh function. Default setting: OFF.

12. SELF CLEAN BUTTON

Press the button to enable/disable the self clean function. Default setting: OFF.

13. LED BUTTON

Press the button to switch the display of the indoor unit on or off. Default setting: ON.

14. MODE DISPLAY

Displays the current selected mode. Including AUTO, COOL, DRY, HEAT and FAN.

15. TRANSMISSION INDICATOR

Displays when the remote controller transmits signals to the indoor unit.

16. TIMER-ON DISPLAY

Displays when the Timer-On function is enabled.

17. TIMER-OFF DISPLAY

Displays when the Timer-Off function is enabled.

18. FAN SPEED DISPLAY

Displays the selected fan speed: AUTO, LOW, MED and HIGH. When AUTO or DRY Mode is selected, the signal "AUTO" will be displayed.

19. QUIET DISPLAY

Displays when Quiet function is activated. The unit will run with the lowest fan speed.

20. SWING UP/DOWN DISPLAY

Displays when Swing function is activated, display matched symbol if you select different up/down direction.

21. 3D SWING DISPLAY

Displays when 3D Swing function is activated.

22. TURBO DISPLAY

Displays when Turbo function is enabled.

23. DIFFUSE DISPLAY

Displays when Diffuse function is enabled.

24. SELF CLEAN DISPLAY

Displays when Self Clean function is enabled.

25. FRESH DISPLAY

Displays when Fresh function is enabled.

26. SLEEP DISPLAY

Displays when Sleep function is enabled.

27. FOLLOW ME DISPLAY

Displays when Follow Me function is enabled.

28. WIRELESS CONTROL DISPLAY

Displays when Wireless Control function is enabled.

29. BATTERY DISPLAY

Displays the battery status of remote control, remind you to replace the battery.

30. ECO DISPLAY

Displays when Eco function is enabled.

31. °C/°F DISPLAY

°C/°F can be switched by pressing \wedge and \vee button at the same time for 3 seconds.



- Some models do not have this function.

32. LOCK DISPLAY

Displays when Lock function is enabled.

33. TEMPERATURE/TIMER/FAN SPEED DISPLAY

Displays the set temperature by default, or Timer setting when using Timer functions.

Timer setting range: 0-24 hours

This display is blank when operating in FAN mode.



- See section "How to use the remote controller" for the the functions description in details.

6. HOW TO USE THE REMOTE CONTROLLER

i Ensure the unit is plugged in and power is available. The OPERATION indicator on the display panel of the indoor unit illuminates.

Basic Operation

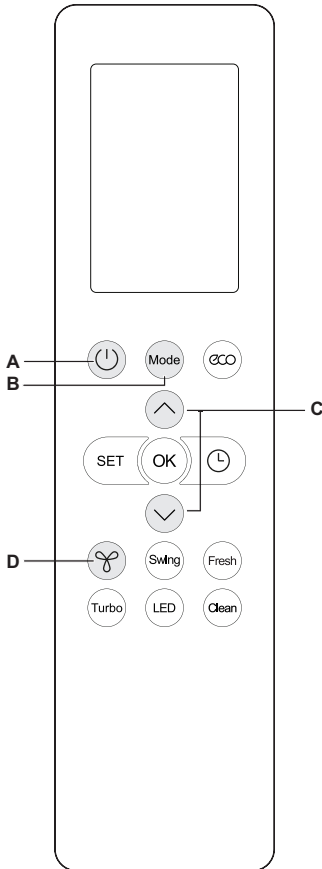

1. Press the ON/OFF button (**A**) to start the air conditioner.
2. Press the MODE button (**B**) to select Auto, Cool, Dry, Fan or Heat mode.
3. Press the \wedge / \vee button (**C**) to set the desired temperature. The temperature can be set in 1°C increments. Keep the button pressed for two seconds to accelerate the process.
4. Press the FAN SPEED button (**D**) to select the fan speed.
5. Press the ON/OFF button (**A**) to turn the air conditioner off.

- i**
- In the Auto mode, the air conditioner can logically choose the mode of Cool, Fan, and Heat by sensing the difference between the actual ambient room temperature and the set temperature on the remote controller.
 - In the Auto and Dry mode, the fan speed can not be switched.
 - In the Fan mode, you can not adjust the setting temperature.

Swing Operation



Vertical

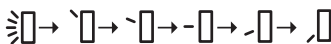

> 2s

Horizontal



Press the Swing button to adjust the desired airflow direction.

1. Press Swing. The air moves up and down. Press Swing again to stop.
2. Press and hold Swing for 2 seconds. The air moves side-to-side. Press and hold for 2 seconds to stop. (Not available on all models)

Timer Operation

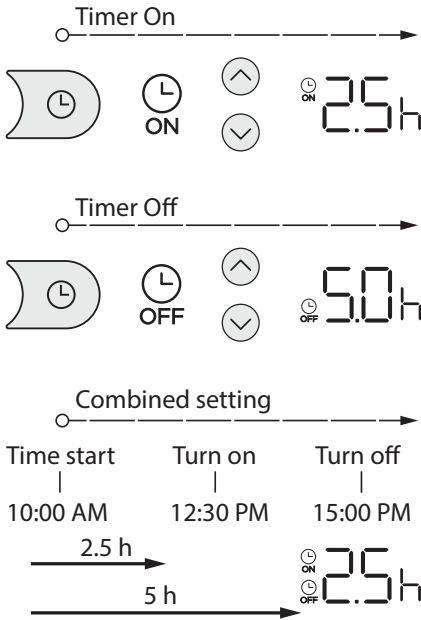

Press the Timer button to set the auto-on time and the auto-off time of the unit.

Example of Timer on setting

1. Press the Timer button. The Timer on symbol and time will show on the display.
2. Press the \wedge or \vee button to set desired Timer on time to turn on the unit after 2.5 hours.
3. Point the remote controller to indoor unit and wait 1 second, then the Timer on function will be activated. The digital display on your remote controller will then return to the temperature display. The Timer on indicator remains on and this function is activated.

Example of Timer off setting

1. Press the Timer button till the Timer off symbol and time show on the display.
2. Press the \wedge or \vee button to set desired Timer off time to turn off the unit after 5 hours.
3. Point the remote controller to indoor unit and wait 1 second, then the Timer off function will be activated. The digital display on your remote controller will then return to the temperature display. The Timer off indicator remains on and this function is activated.



- When setting the Timer on or Timer off functions, up to 10 hours, the time will increase in 30 minute increments with each press. After 10 hours and up to 24, it will increase in 1 hour increments. The timer will revert to zero after 24 hours.
- You can cancel either function by setting its timer to "0.0h".

Example of Combined Timer setting

It is 10:00 AM and you want to start the air conditioner after 2.5 hours and stop it after 5 hours.

1. Follow the Timer on setting to set the turn on time to 2.5 hours.

2. Continue press the Timer button to set the turn off time to 5 hours.
3. Both the Timer on and Timer off indicators display on the remote controller, the combined Timer setting is activated.
4. Then the unit will turn on at 12:30 PM and turn off at 15:00 PM.

Advanced Functions Operations

Button	Display
1 — Turbo	
2 — Clean	
3 — More than 2 seconds	
4 — 2 times in 1 second	FP
5 —	eco
6 —	
7 — Turbo More than 7 seconds	
8 — 7 times in 10 seconds	
9 — Turbo Clean	
10 —	

1. Turbo function

Press the Turbo button to enable or disable the turbo function. The Turbo function makes the unit work extra hard to reach your set temperature in the shortest time as soon as possible. When you need fast cool or heat, you can choose this function.

2. Self Clean function

Press the Clean button to activate the Self Clean feature, your unit will clean itself automatically. After cleaning, unit will turn off automatically. Airborne bacteria can grow in the moisture that condenses around heat exchanger in the unit. With regular use, most of this moisture is evaporated from the unit. You can use self clean feature as often as you like.

- You may hear “cracking” noise during the self clean function, this is normal.

3. Quiet function

Press the Fan button for more than 2 seconds to enable or disable the Quiet function.

When in Quiet function, the fan will run in slowest speed. This function is aim to give you a comfortable low noise environment, ideal for bedrooms.

4. 8°C Heating function

When the air conditioner operates under heat mode with the temperature of minimum setting, press “” button twice in one second will activate 8°C Heating function. The unit will operate at a setting temperature 8°C and the indoor unit display shows “FP”.

5. ECO function

In Cool mode, press ECO button to enter the energy efficient mode.

Under cooling mode, press the button, the remote controller will adjust the temperature automatically to 24°C, fan speed of Auto to save energy (only when the set temperature is less than 24°C. If the set temperature is above 24°C, press the button, the fan speed will change to Auto, the set temperature will remain unchanged.



- Pressing the ECO button, or modifying the mode or adjusting the set temperature to less than 24°C will stop ECO operation.
- Under ECO operation, the set temperature should be 24°C or above, it may result in insufficient cooling. If you feel uncomfortable, just press the ECO button again to stop it.

6. Fresh function

Press the Fresh button to activate the Health function. When the function is initiated, the Ionizer/Plasma Dust Collector (depending on models) is energized and will help to clean the air. This function is recommended when the indoor air quality is in bad condition.

7. Follow Me function

Keep pressing Turbo button for more than 7 seconds to activate memory feature of Follow Me function. The Follow Me function enables the remote control to measure the temperature at its current location and send this signal to the air conditioner every 3 minutes. When using AUTO, COOL or HEAT modes, measuring ambient temperature from the remote controller (instead of from the indoor unit itself) will enable the air conditioner to optimize the temperature around you and ensure maximum comfort.



- If the memory feature is activated, “ON” displays for 3 seconds on the screen.

- Press the Set and OK buttons to deactivate the Follow Me feature, refer to Set function description for the details.
- If the memory feature is inactivated, “OF” displays for 3 seconds on the screen.
- While the memory feature is activated, press the ON/OFF button, shift the mode or power failure will not cancel the Follow me function.

8. Wireless function

Press and hold the “LED” button on the remote control until the symbol of wireless network blinks on the air conditioner front panel. Then enter the wireless binding status.





- Please refer to the “Quick Connection Guide” for the Wireless connection details.

9. Lock function

Press Turbo and Clean buttons at the same time for 5 seconds, you can lock the remote controller, and press Turbo and Clean buttons at the same time for 1 second to unlock it.

10. Set function

Press the Set button to enter the function selection, then press Set button or  and  button to select the desired



function. The matched symbol will flash on the display area, press the OK button to confirm. To cancel the selected function, just perform the same procedures as above.



- If your remote controller already has Diffuse button, Fresh button or Sleep button, you can not use the SET button to select the Diffuse, Fresh or Sleep feature.

11. Diffuse function (optional)

Press the Set button to activate the Diffuse function. This feature avoids direct air flow blowing on the body.

12. Sleep function

Press the Set button to activate the Sleep function. When you activate the Sleep function, the economic running function will be activated, the set temperature will increase (cooling) or decrease (heating) by 1°C per hour over a 2 hour period. The final temperature will then be maintained till further changes made by the user.

 The SLEEP function is not available in FAN or DRY mode.

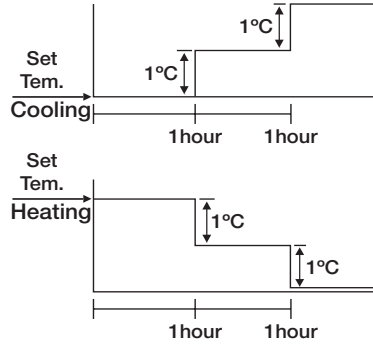

7. HOW TO USE THE INDOOR UNIT

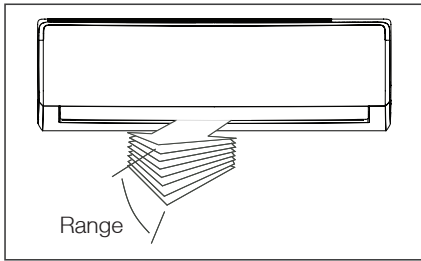

1. Adjust the air flow direction properly otherwise it might cause discomfort or cause uneven room temperatures.
2. Adjust the horizontal louver using the remote controller.
3. Adjust the vertical louver using the remote controller.
4. Adjust the vertical louver manually (For models without 3D Swing function).

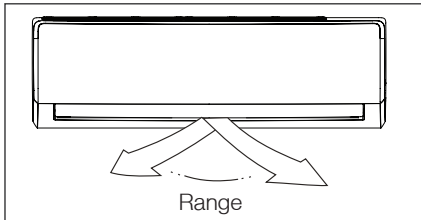

To set the vertical air flow (Up - Down) direction

Perform this function while the unit is in operation. Use the remote controller to adjust the air flow direction. The horizontal louver can swing up and down automatically.



WARNING!

- Do not operate the air conditioner for long periods with the air flow direction set downward in cool or dry mode. Otherwise, condensation may occur on the surface of the horizontal louver causing moisture to drop on to the floor or on furnishings.
- When the air conditioner is started immediately after it was stopped, the horizontal louver might not move for approximately 10 seconds. Louver in closed position.

To set the horizontal air flow direction (Left - Right)

Perform this function while the unit is in operation. Use the remote controller to adjust the air flow direction. The vertical louver can swing left and right automatically.

IMPORTANT!

- Do not put your fingers into the panel of blower and suction side. The high-speed fan inside may cause danger.
- Open angle of the horizontal louver should not be set too small, as COOLING or HEATING performance may be impaired due to too restricted air flow area.
 - Do not move the horizontal louver manually, otherwise the horizontal louver will be out of sync. Please cease operating, unplug power for a few seconds, then restart the air conditioner.
 - Do not operate unit with horizontal louver in closed position.

8. OPERATING TEMPERATURE

	COOL mode	HEAT mode	DRY mode
Room Temperature	17°C - 32°C	0°C - 30°C	10°C - 32°C
Outdoor Temperature	0°C - 50°C	-5°C - 24°C	0°C - 50°C

IMPORTANT!

1. Optimum performance will be achieved within these operating temperatures. If air conditioner is used outside of the above conditions, certain safety protection features might come into operation and cause the unit to function abnormally.
2. If the air conditioner runs for a long time in cooling mode and the humidity is high, condensed water may drip out of the unit. Please sets the vertical air flow louver to its maximum angle (vertically to the floor), and set HIGH fan mode.

9. EMERGENCY OPERATION

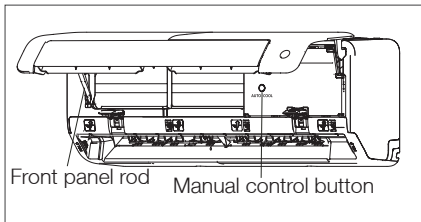

Units are equipped with a switch to run emergency operation mode. It can be accessed by opening the front panel. This switch is used for manual operation in case the remote controller fails to work or maintenance is necessary.

1. Open and lift the front panel up to an angle until it remains fixed with a clicking sound.
2. One press of the manual control switch will lead to the forced AUTO operation. If press the switch twice within five seconds, the unit will operate under forced COOL operation.
3. Push and fold the front panel rod, then close the panel firmly to its original position.



- The unit must be turned off before operating the manual control button. If the unit is operational, continue pressing the manual control button until the unit is off.
- This switch is only to be used for operation when the remote controller is not available.
- To restore the remote controller operation, use the remote controller directly.

10. CLEANING AND MAINTENANCE

10.1 Before Maintenance

Turn the system off before cleaning. To clean, wipe with a soft, dry cloth. Do not use bleach or abrasives.



WARNING!

Power supply must be disconnected before cleaning the indoor unit.

- A cloth dampened with cold water may be used on the indoor unit if it is very dirty. Then wipe it with a dry cloth.
- Do not use a chemically treated cloth or duster to clean the unit.
- Do not use benzene, thinner, polishing powder, or similar solvents for cleaning. These may cause the plastic surface to crack or deform.
- Never use water hotter than 40°C to clean the front panel, it could cause deformation and discoloration.

10.2 Cleaning the Unit

Wipe the unit with a soft dry cloth only. If the unit is very dirty, wipe it with a cloth soaked in warm water.

10.3 Cleaning the Filters

A clogged air filter reduces the cooling efficiency of this unit. Please clean the filter once every 2 weeks.

1. The air filter is on the top of the air conditioner.
2. Hold both side of the top filter in the place marked with "PULL", then pull it upwards.

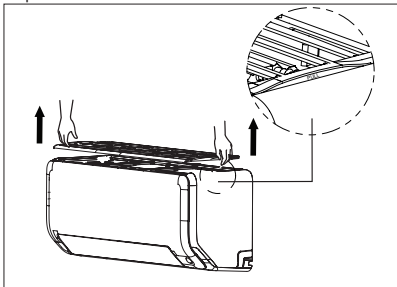

3. If your filter has small air freshening filters, unclip them from the larger filter. Clean these air freshening filters with a hand-held vacuum.

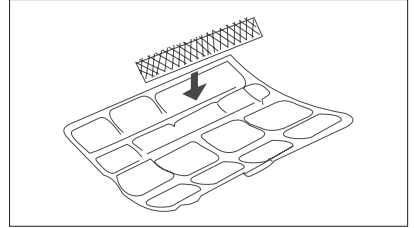

4. Clean the large air filter with warm, soapy water. Be sure to use a mild detergent.
5. Rinse the filter with fresh water, then shake off excess water.

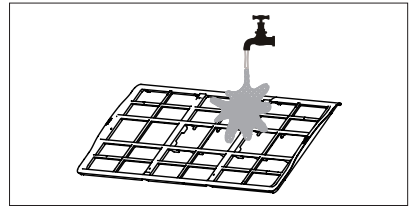

6. Dry it in a cool, dry place, and refrain from exposing it to direct sunlight.
7. When dry, re-clip the air freshening filter to the larger filter, then install it back on the indoor unit.

10.4 Cleaning the Air Outlet and the Panel

1. Use a dry and soft cloth to wipe it.
2. Pure water or mild detergent may be used if it is very dirty.



WARNING!

- Do not use benzene, thinner, polishing powder, or similar solvents for cleaning. These may cause the surface to crack or deform.
- To avoid the risk of electrical shock or fire, do not let water fall into the indoor unit.
- Never wipe the air flow louver violently.

- An air conditioner without air filter can not expel the dust out of the room, which would cause malfunctions by accumulation.

**WARNING!**

The filter must be installed before you operate the air conditioner.

10.5 Replacing the Filters

1. Remove the air filter.
2. Remove the air freshening filter.
3. Install a new air freshening filter.
4. Reinstall the air filter.

10.6 Preparation for Extended Non-operation

If you plan to idle the unit for a long time, perform the following:

1. Clean the indoor unit and filters.
2. Operate the fan for about half a day to dry the inside of the unit.
3. Stop the air conditioner and disconnect power.
4. Remove the batteries from the remote controller. The outdoor unit requires periodic maintenance and cleaning. Do not attempt to do this yourself. Contact your dealer or service provider.

10.7 Pre-season Inspection

1. Check that the wiring is not broken off or disconnected.
2. Clean the indoor unit and filters.
3. Check that the air filter is installed.
4. Check if the air outlet or inlet is blocked after the air conditioner has not been used for a long time.

**WARNING!**

- Do not touch the metal parts of the unit when removing the filter. Injuries can occur when handling sharp metal edges.
- Do not use water to clean inside the air conditioner. Exposure to water can destroy the insulation, leading to possible electric shock.
- When cleaning the unit, first make sure that the power and circuit breaker are turned off.
- Do not wash air filter with hot water at more than 40°C. Shake off moisture completely and dry it in the shade. Do not expose it directly to the sun, it may shrink.

11. OPERATION TIPS

The following events may occur during normal operation.

1. Protection of the air conditioner Compressor

- The compressor can't restart for 3-4 minutes after it stops.

2. Anti-cold air (Cooling and heating models only)

- The unit is designed not to blow cold air on HEAT mode, when the indoor heat exchanger is in one of the following three situations and the set temperature has not been reached.

- A) When heating has just started.
- B) Defrosting.
- C) Low temperature heating.

- The indoor or outdoor fan stop running when defrosting (Cooling and heating models only).

3. Defrosting (Cooling and heating models only)

- Frost may be generated on the outdoor unit during heat cycle when outdoor temperature is low and humidity is high resulting in lower heating efficiency of the air conditioner.
- During this condition air conditioner will stop heating operation and start defrosting automatically.
- The time to defrost may vary from 4 to 10 minutes according to the outdoor temperature and the amount of frost built up on the outdoor unit.

4. A white mist coming out from the indoor unit

- A white mist may generate due to a large temperature difference between air inlet and air outlet on COOL mode in an indoor environment that has a high relative humidity.
- A white mist may generate due to moisture generated from defrosting process when the air conditioner restarts in HEAT mode operation after defrosting.

5. Abnormal noise of the air conditioner

- You may hear a low hissing sound when the compressor is running or has just stopped running. It is the sound of the refrigerant flowing or coming to a stop.
- You can also hear a low "squeak" sound when the compressor is running or has just stopped running. This is caused by heat expansion and cold contraction of the plastic parts in the unit when the temperature is changing.
- A noise may be heard due to louver restoring to its original position when power is turned on.

6. Dust is blown out from the indoor unit

This is a normal condition when the air conditioner has not been used for a long time or during first use of the unit.

7. A peculiar smell comes out from the indoor unit

This is caused by the indoor unit giving off smells permeated from building material, from furniture, or smoke.

8. The air conditioner turns to FAN only mode from COOL or HEAT (For cooling and heating models only) mode

When the indoor temperature reaches the set temperature of the air conditioner, the compressor will stop automatically and the air conditioner turns to FAN only mode. The compressor will start again when the indoor temperature rises on COOL mode or falls on HEAT mode (For cooling and heating models only).

9. Insufficient Heat (For cooling and heating models only)

The air conditioner draws in heat from the outdoor unit and releases it via the indoor unit during heating operation. When the outdoor temperature falls, heat drawn in by the

air conditioner decreases accordingly. At the same time, heat loading of the air conditioner increases due to larger difference between indoor and outdoor temperature. If a comfortable temperature can't be achieved by the air conditioner, we suggest you use a supplementary heating device.

10.Auto-restart function

- Power failure during operation will stop the unit completely.
- For the unit without Auto-restart feature, when the power restores, the OPERATION indicator on the indoor unit will flash for 1 second. To restart the operation, push the ON/OFF button on the remote controller. For the unit with Auto-restart feature, when the power restores, the unit restarts automatically with all the previous settings preserved by the memory function.

12. TROUBLESHOOTING

Trouble	OPERATION (RUN) indicator or other indicators continue flashing.	The unit may stop operation or continue to run in a safety condition (depending on models). Waiting for about 10 minutes, the fault may be recovered automatically, if not, disconnect the power and then connect it in again. If the problem still exists, disconnect the power and contact the nearest customer service center.
	If one of the following code appears on the display area: <ul style="list-style-type: none"> • E(x), P(x), F(x) • EH(xx), EL(xx), EC(xx) • PH(xx), PL(xx), PC(xx) 	
	Fuse blows frequently or circuit breaker trips frequently.	Stop the air conditioner immediately, disconnect the power and contact the nearest customer service center.
	Other objects or water fall into the air conditioner.	
Terrible odors are smelled or abnormal sounds are heard.		

Malfunctions	Cause	What should be done?
Unit does not start	Power cut	Wait for power to be restored.
	Unit may have become unplugged.	Check that plug is securely in wall receptacle.
	Fuse may have blown.	Replace the fuse.
	Battery in Remote controller may have been exhausted.	Replace the battery.
	The time you have set with timer is incorrect.	Wait or cancel timer setting.
Unit not cooling or heating (Cooling/heating models only) room very well while air flowing out from the air conditioner	Inappropriate temperature setting.	Set temperature correctly. For detailed method please refer to "HOW TO USE THE REMOTE CONTROLLER" section.
	Air filter is blocked.	Clean the air filter.
	Doors or Windows are open.	Close the doors or windows.
	Air inlet or outlet of indoor or outdoor unit has been blocked.	Clear obstructions away first, then restart the unit.
	Compressor 3 minutes protection has been activated.	Wait
If the trouble has not been corrected, please contact a local dealer or the nearest customer service center. Be sure to inform them of the detailed malfunctions and unit model number. Do not attempt to repair the unit yourself. Always consult an authorized service provider.		

13. ENVIRONMENTAL CONCERNS

- Most of the packing materials are recyclable. Please dispose of those materials through your local recycling depot or by placing them in appropriate collection containers.
- If you wish to discard this air conditioner, please contact your local authorities and ask for the correct method of disposal.



® and WESTINGHOUSE are trademarks of Westinghouse Electric Corporation.
Used under license. All Rights Reserved.