

**Dish Washer**

# **USER MANUAL**

**MDW6065F14UX**

Warning notices: Before using this product, please read this manual carefully and keep it for future reference. The design and specifications are subject to change without prior notice for product improvement. Consult with your dealer or manufacturer for details. The diagram above is just for reference. Please take the appearance of the actual product as the standard.

## THANK YOU LETTER

Thank you for choosing Midea! Before using your new Midea product, please read this manual thoroughly to ensure that you know how to operate the features and functions that your new appliance offers in a safe way.

# CONTENTS

<b>THANK YOU LETTER</b>	01
<b>SAFETY INSTRUCTIONS</b>	02
<b>SPECIFICATIONS</b>	08
<b>PRODUCT OVERVIEW</b>	10
<b>QUICK START GUIDE</b>	11
<b>PRODUCT INSTALLATION</b>	12
<b>OPERATION INSTRUCTIONS</b>	16
<b>CLEANING AND MAINTENANCE</b>	29
<b>TROUBLESHOOTING</b>	32
<b>TRADEMARKS, COPYRIGHTS AND LEGAL STATEMENT</b>	36
<b>DISPOSAL AND RECYCLING</b>	37
<b>DATA PROTECTION NOTICE</b>	38

# SAFETY INSTRUCTIONS

## Intended Use

- The following safety guidelines are intended to prevent unforeseen risks or damage from unsafe or incorrect operation of the appliance. Please check the packaging and appliance on arrival to make sure everything is intact to ensure safe operation. If you find any damage, please contact the retailer or dealer.
- Please note modifications or alterations to the appliance are not allowed for your safety concern. Unintended use may cause hazards and loss of warranty claims.

## Explanation of Symbols

### Danger



This symbol indicates that there are dangers to the life and health of persons due to extremely flammable gas.

### Warning of electrical voltage



This symbol indicates that there is a danger to life and health of persons due to voltage.

### Warning



The signal word indicates a hazard with a medium level of risk which, if not avoided, may result in death or serious injury.

### **Caution**



The signal word indicates a hazard with a low degree of risk which, if not avoided, may result in minor or moderate injury.

### **Attention**



The signal word indicates important information (e.g. damage to property), but not danger.

### **Observe instructions**



This symbol indicates that a service technician should only operate and maintain this appliance in accordance with the operating instructions.

Read these operating instructions carefully and attentively before using/commissioning the unit and keep them in the immediate vicinity of the installation site or unit for later use!

## **DANGER: Risk of Fire/Flammable materials**

- **When using your dishwasher, follow the precautions listed below:**
- Installation and repair can only be carried out by a qualified technician.
- This appliance is intended to be used in household and similar applications such as:
  - staff kitchen areas in shops, offices and other working environments;
  - farm houses;
  - by clients in hotels, motels and other residential type environments;
  - bed and breakfast type environments.
- This appliance can be used by children aged from 8 years and above and persons with reduced physical, sensory or mental capabilities or lack of experience and knowledge if they have been given supervision or instruction concerning use of the appliance in a safe way and understand the hazards involved.
- Children shall not play with the appliance. Cleaning and user maintenance shall not be done by children without supervision. (For EN60335-1)
- This appliance is not intended for use by persons (including children) with reduced physical, sensory or mental capabilities, or lack of experience and knowledge, unless they have been given supervision or instruction concerning use of the appliance by a person responsible for their safety. (For IEC60335-1)
- Packaging material could be dangerous for children!
- Children should be supervised to ensure that they do not play with the appliance.  
This appliance is for indoor household use only.

To protect against the risk of electrical shock, do not immerse the unit, cord or plug in water or other liquid.

- Please unplug before cleaning and maintenance the appliance. Use a soft cloth moisten with mild soap, and then use a dry cloth to wipe it again.
- If the supply cord is damaged, it must be replaced by the manufacturer or its service agent or a similarly qualified person in order to avoid a hazard.

### **Earthing Instructions**

- This appliance must be earthed. In the event of a malfunction or breakdown, earthing will reduce the risk of an electric shock by providing a path of least resistance of electric current. This appliance is equipped with an earthing conductor plug.
- The plug must be plugged into an appropriate outlet that is installed and earthed in accordance with all local codes and ordinances.
- Extension sockets are forbidden.
- Improper connection of the equipment-earthing conductor can result in the risk of an electric shock.
- Check with a qualified electrician or service representative if you are in doubt whether the appliance is properly grounded.
- Do not modify the plug provided with the appliance if it does not fit the outlet.
- Have a proper outlet installed by a qualified electrician.
- Do not abuse, sit on, or stand on the door or dish rack of the dishwasher.
- Do not operate your dishwasher unless all enclosure panels are properly in place.
- Open the door very carefully if the dishwasher is

- operating, there is a risk of water squirting out.
- Do not place any heavy objects on or stand on the door when it is open. The appliance could tip forward.
  - When loading items to be washed:
    - 1) Locate sharp items so that they are not likely to damage the door seal;
    - 2) Warning: Knives and other utensils with sharp points must be loaded in the basket with their points facing down or placed in a horizontal position.
  - Some dishwasher detergents are strongly alkaline. They can be extremely dangerous if swallowed. Avoid contact with the skin and eyes and keep children away from the dishwasher when the door is open.
  - Check that there are no detergent residues after completion of the wash cycle.
  - Do not wash plastic items unless they are marked “dishwasher safe” or the equivalent.
  - For unmarked plastic items not so marked, check the manufacturer’s recommendations.
  - Use only detergent and rinse agents recommended for use in an automatic dishwasher.
  - Never use soap, laundry detergent, or hand washing detergent in your dishwasher.
  - The door should not be left open, since this could increase the risk of tripping.
  - If the supply cord is damaged, it must be replaced by the manufacturer or its service agent or a similarly qualified person in order to avoid a hazard.
  - During installation, the power supply must not be excessively or dangerously bent or flattened.
  - Do not tamper with controls.

- The appliance needs to be connected to the main water valve using new hose sets. Old sets should not be reused.
- The appliance needs to be connected to the main water valve using new hose sets. Old sets should not be reused.
- To save energy, in stand by mode , the appliance will switch off automatically while there is no any operation in 30 minutes .

## Disposal

- For disposing of package and the appliance please go to a recycling center. Therefore cut off the power supply cable and make the door closing device unusable.
- Cardboard packaging is manufactured from recycled paper and should be disposed in the waste paper collection for recycling.
- By ensuring this product is disposed of correctly, you will help prevent potential negative consequences for the environment and human health, which could otherwise be caused by inappropriate waste handling of this product.
- For more detailed information about recycling of this product, please contact your local city office and your household waste disposal service.
- **DISPOSAL: Do not dispose this product as unsorted municipal waste. Collection of such waste separately for special treatment is necessary.**

# SPECIFICATIONS

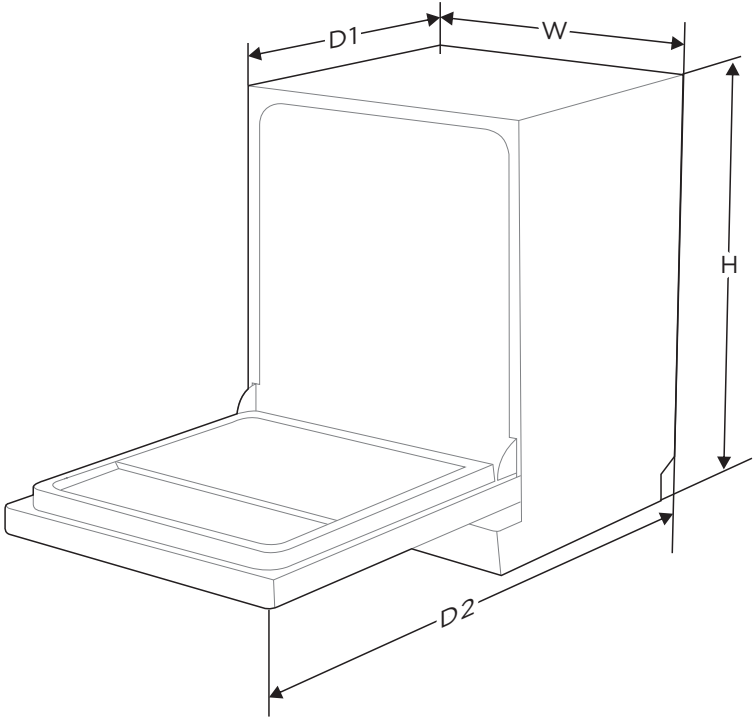

Height (H)	845 mm
Width (W)	598 mm
Depth (D1)	600 mm (with the door closed)
Depth (D2)	1175 mm (with the door opened 90°)

## Product information sheet

Manufacturer	MIDEA
Type/Description	MDW6065F14UX
Standard place settings	14
Energy efficiency class	 3.0
Water consumption class	 4.5
Standard cleaning cycle	ECO
Energy consumption of the standard cleaning cycle	0.85 kWh
Water consumption of the standard cleaning cycle	12.7 liter
Program duration of the standard cleaning cycle	180 min
Noise level	52 dB(A) re 1 pW
Mounting	Free standing
Could be built-in	YES
Power consumption	1760-2100W
Rated voltage/frequency	AC 220-240V/50Hz
Water pressure (flow pressure)	0.04-1.0MPa=0.4-10 bar

# PRODUCT OVERVIEW

## Product

### ● IMPORTANT

To get the best performance from your dishwasher, read all operating instructions before using it for the first time.

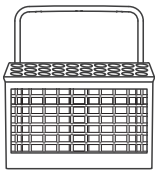
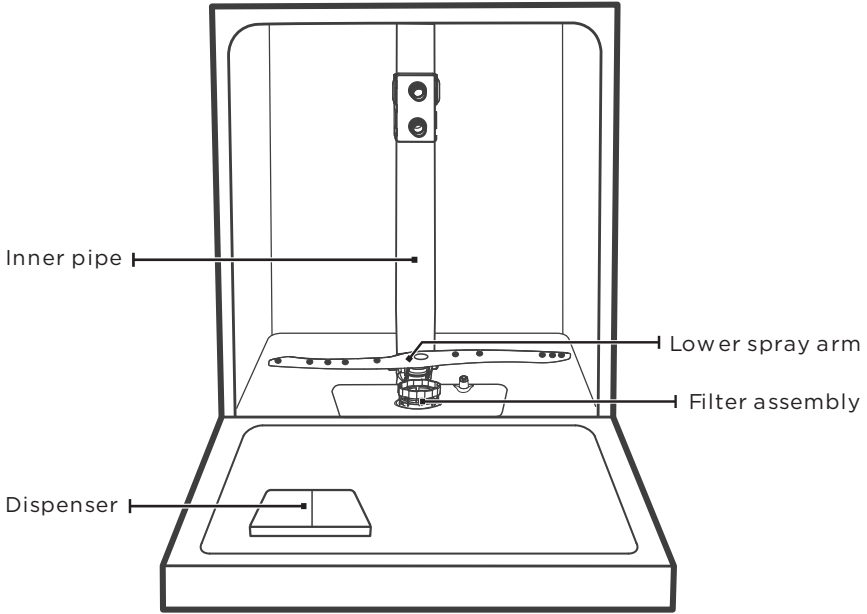

Cutlery basket

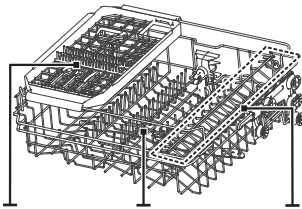

Cutlery rack Upper spray arm Cup rack  
Upper basket

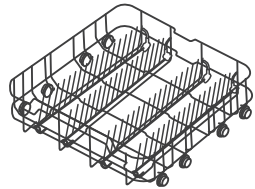

Lower basket

### ● NOTE :

Pictures are only for reference, different models may be different. Please prevail in kind.

# QUICK START GUIDE

**Please read the corresponding content in the instruction manual for detailed operating method.**

1. Install the dishwasher

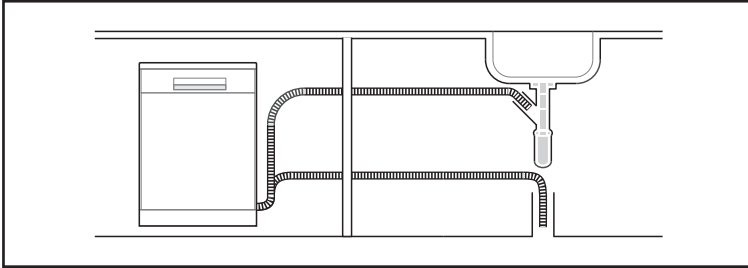

2. Remove larger residue from dishes.  
Avoid pre-rinsing.



3. Load the baskets.

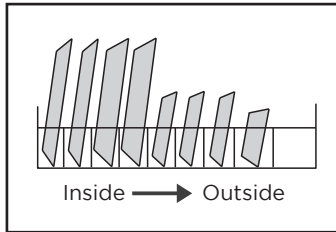

4. Fill the dispenser with detergent and rinse aid.

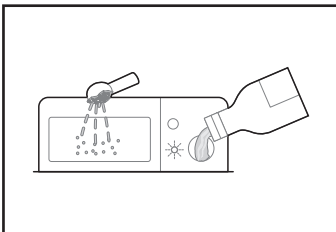

5. Select a suitable program and start the dishwasher.

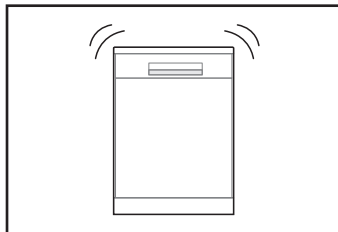

# PRODUCT INSTALLATION

## WARNING



**Electrical Shock Hazard**  
Disconnect electrical power before installing dishwasher.  
Failure to do so could result in death or electrical shock.

## Attention

The installation of the pipes and electrical equipments should be done by professionals.

### About Power Connection

## WARNING

**For personal safety:**

**Do not use an extension cord or an adapter plug with this appliance.**  
**Do not, under any circumstances, cut or remove the earthing connection from the power cord.**

### Electrical requirements

Please look at the rating label to know the rating voltage and connect the dishwasher to the appropriate power supply. Use the required fuse 10A/13A/16A, time delay fuse or circuit breaker recommended and provide separate circuit serving only this appliance.

### Electrical connection

Ensure the voltage and frequency of the power being corresponds to those on the rating plate. Only insert the plug into an electrical socket which is earthed properly. If the electrical socket to which the appliance must be connected is not appropriate for the plug, replace the socket, rather than using a adaptors or the like as they could cause overheating and burns.

 **Ensure that proper earthing exists before use**

### Water Supply And Drain

#### Cold water connection

Connect the cold water supply hose to a threaded 3/4(inch) connector and make sure that it is fastened tightly in place.

If the water pipes are new or have not been used for an extended period of time, let the water run to make sure that the water is clear. This precaution is needed to avoid the risk of the water inlet to be blocked and damage the appliance.

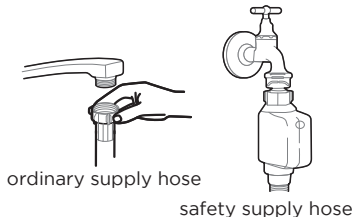

## About the safety supply hose

The safety supply hose consists of the double walls. The system guarantees its intervention by blocking the flow of water in case of the supply hose breaking and when the air space between the supply hose itself and the outer corrugated hose is full of water.

### **⚠ WARNING**

A hose that attaches to a tap can burst if it is installed on the same water line as the dishwasher. If your sink has one, it is recommended that the hose be disconnected and the hole plugged.

## How to connect the safety supply hose

1. Pull the safety supply hoses out from storage compartment located at rear of dishwasher.
2. Tighten the screws of the safety supply hose to the faucet with thread 3/4inch.
3. Turn the water fully on before starting the dishwasher.

## How to disconnect the safety supply hose

1. Turn off the water.
2. Unscrew the safety supply hose from the faucet.

## Connection Of Drain Hoses

Insert the drain hose into a drain pipe with a minimum diameter of 4 cm, or let it run into the sink, making sure to avoid bending or crimping it. The height of drain pipe must be less than 1000 mm. The free end of the hose must not be immersed in water to avoid the back flow of it.

**⚠** Please securely fix the drain hose in either position A or position B

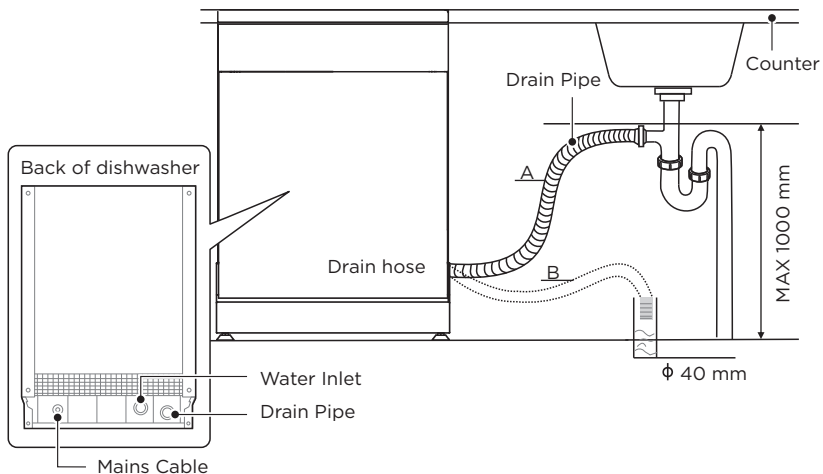

## How to drain excess water from hoses

If the connection to the drain pipe is positioned higher than 1000 mm, excess water may remain in the drain hose. It will be necessary to drain excess water from the hose into a bowl or suitable container that is held outside and lower than the sink.

## Water outlet

Connect the water drain hose. The drain hose must be correctly fitted to avoid water leaks. Ensure that the water drain hose is not kinked or squashed.

## Extension hose

If you need a drain hose extension, make sure to use a similar drain hose. It must not be longer than 4 meters, otherwise the cleaning effect of the dishwasher could be reduced.

## Syphon connection

The waste connection must be at a height less than 1000 mm (maximum) from the bottom of the dishwasher.

## Positioning The Appliance

Position the appliance in the desired location. The back should rest against the wall behind it, and the sides, along the adjacent cabinets or walls. The dishwasher is equipped with water supply and drain hoses that can be positioned either to the right or the left sides to facilitate proper installation.

## Levelling the appliance

Once the appliance is positioned for levelling, the height of the dishwasher may be altered via adjustment of the screwing level of the feet.

In any case, the appliance should not be inclined more than 2°

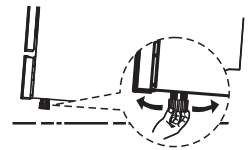

## Free Standing Installation

### Type 1: Fitting between existing carbinets

The height of the dishwasher, 845 mm, has been designed in order to allow the machine to be fitted between existing cabinets of the same height in modern fitted kitchens. The feet can be adjusted so that correct height is reached.

The laminated top of the machine does not require any particular care since it is heatproof, scratchproof and stainproof.

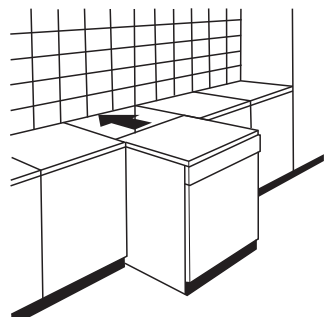

## Type 2: Underneath existing work top

(When fitting beneath a work top)

In most modern fitted kitchens there is only one single work top under which cabinets and electrical appliances are fitted. In this case remove the work top of the dishwasher by unscrewing the screws under the rear edge of the top (a).

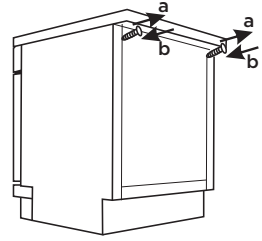

### ⚠ Attention

After removing the work top, the screws must be screwed again under the rear edge of the top (b).

## Selecting the best location for the dishwasher

The installation position of the dishwasher should be near the existing inlet and drain hose and power socket.

Illustrations of cabinet dimensions and installation position of the dishwasher.

1. Less than 5 mm between the top of dishwasher and cabinet and the outer door aligned to cabinet.

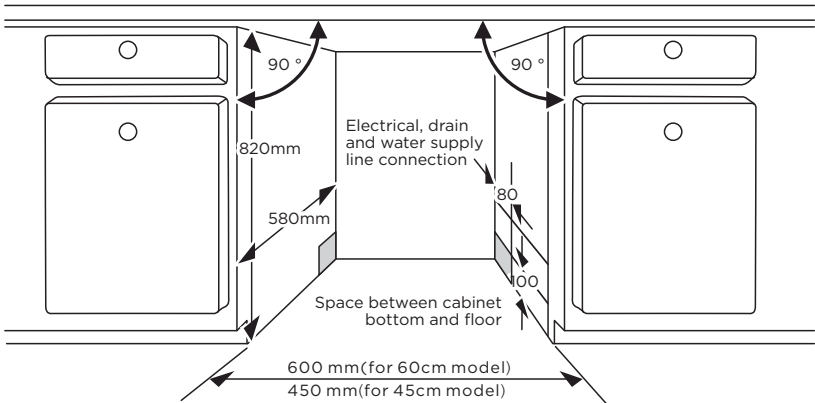

2. If dishwasher is installed at the corner of the cabinet, there should be some space when the door is opened.

⚠ Depending on where your electrical outlet is, you may need to cut a hole in the opposite cabinet side.

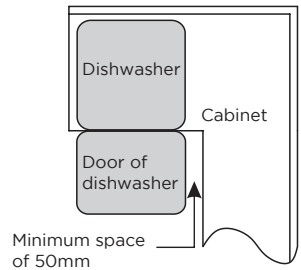





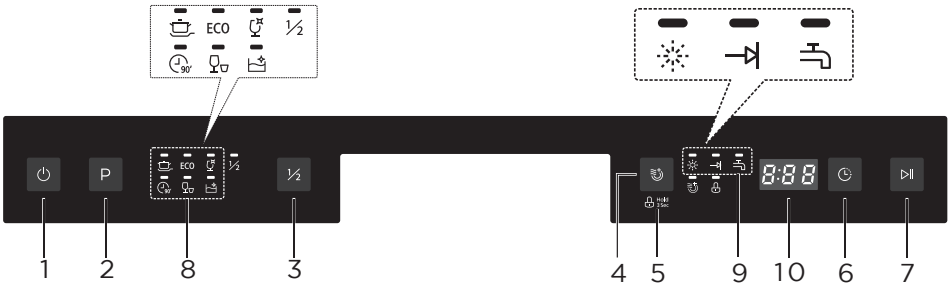





# OPERATION INSTRUCTIONS

## Control Panel







No.	Icon	Description	Description
No.1		Power	<ul style="list-style-type: none"> <li>Press this button to power on or power off your dishwasher.</li> </ul>
No.2		Program	<ul style="list-style-type: none"> <li>Select the appropriate washing program, the selected program indicator will be lit.</li> </ul>
No.3		Half-load	<ul style="list-style-type: none"> <li>When you have about or less than 6 place setting dishware to wash, you can choose this function to save energy and water.(It can only be used with Intensive, ECO, Glass and 90 min.)</li> </ul>
No.4		Extra Drying	<ul style="list-style-type: none"> <li>For better drying result. (It can not be used with Rapid and Soak.)</li> </ul>
No.5		Child lock	<ul style="list-style-type: none"> <li>This option allows you to lock the buttons on the control panel - except the Power button - so children cannot accidentally start the dishwasher by pressing the buttons on the panel. To lock or unlock the buttons on the control panel, press the Extra drying button for 3 seconds.</li> </ul>
No.6		Delay	<ul style="list-style-type: none"> <li>Press this button to set the delayed hours for washing. You can delay the start of washing up to 24 hours. One press on this button delays the start of washing by one hour.</li> </ul>
No.7		Start/Pause	<ul style="list-style-type: none"> <li>After completing program and function selection or delay time setting, press this button to start or pause.</li> <li>When the washing program is running, after the program is suspended by opening the door.</li> </ul>

Description		
No.8 Program indicators	 Intensive	<ul style="list-style-type: none"> <li>For heaviest soiled crockery, and normally soiled pots, pans, dishes etc. With dried-on food.</li> </ul>
	ECO ECO	<ul style="list-style-type: none"> <li>This is standard program, it is suitable to clean normally soiled tableware and it is the most efficient program in terms of its combined energy and water consumption for that type of tableware.</li> </ul>
	 Glass	<ul style="list-style-type: none"> <li>For lightly soiled crockery and glass.</li> </ul>
	 90 min	<ul style="list-style-type: none"> <li>For normally soiled loads that need 90 min wash.</li> </ul>
	 Rapid	<ul style="list-style-type: none"> <li>A shorter wash for lightly soiled loads that do not need drying.</li> </ul>
	 Self-Cleaning	<ul style="list-style-type: none"> <li>This program provides an effective cleaning of the dishwasher itself.</li> </ul>
No.9 Warning indicators	 Rinse aid	<ul style="list-style-type: none"> <li>If the “” indicator is lit, it means the dishwasher is low on dishwasher rinse aid and needs to be refilled.</li> </ul>
	 Program end	<ul style="list-style-type: none"> <li>When the program is end, the indicator will be lit.</li> </ul>
	 Water Faucet	<ul style="list-style-type: none"> <li>If the “” indicator is lit, it means the water faucet closed.</li> </ul>

## Programmes

The table below shows which programs are best for the levels of food residue on them and how much detergent is needed. It also show various information about the programs. Consumption values and program duration are only indicative except for the ECO program.

(●) indicates that the program uses rinse aid in the last rinse.

Program	Description Of Cycle	Detergent Pre/Main Wash	Running Time(min)	Energy (kWh)	Water (L)	Rinse Aid
 Intensive	Prewash(50°C) Wash(60°C) Rinse Rinse(65°C) Drying	$\frac{5/27.5g}{\text{Or all in 1}}$	170	1.600	18.5	●
<b>ECO</b> (*AS/NZS 2007.1)	Prewash Wash (45°C) Rinse Rinse (52°C) Drying	$\frac{5/27.5g}{\text{Or all in 1}}$	180	0.850	12.7	●
 Glass	Prewash Wash (42°C) Rinse Rinse (60°C) Drying	$\frac{5/27.5g}{\text{Or all in 1}}$	125	0.900	14.5	●
 90 min	Wash (65°C) Rinse Rinse (65°C) Drying	$\frac{32.5g}{\text{Or all in 1}}$	90	1.200	11.5	●
 Rapid	Wash (40°C) Rinse Rinse (45°C)	27.5g	30	0.600	11.5	○
 Self-Cleaning	Wash (70°C) Rinse Rinse (70°C) Drying	32.5g	100	1.200	11.0	●

### NOTE

ECO : This program is the test cycle. The information for comparability test in accordance with \*AS/NZS 2007.1

## Preparing And Loading Dishes

Consider buying utensils which are identified as dishwasher-proof.

For particular items, select a program with the lowest possible temperature.

To prevent damage, do not take glass and cutlery out of the dishwasher immediately after the program has ended.

### For washing the following cutlery/dishes

#### Are not suitable

Cutlery with wooden, horn china or mother-of-pearl handles

Plastic items that are not heat resistant

Older cutlery with glued parts that are not temperature resistant

Bonded cutlery items or dishes

Pewter or cooper items

Crystal glass

Steel items subject to rusting

Wooden platters

Items made from synthetic fibres

#### Are of limited suitability

Some types of glasses can become dull after a large number of washes

Silver and aluminum parts have a tendency to discolor during washing

Glazed patterns may fade if machine washed frequently

### Recommendations for loading the dishwasher

Scrape off any large amounts of leftover food. Soften remnants of burnt food in pans. It is not necessary to rinse the dishes under running water.

For best performance of the dishwasher, follow these loading guidelines.

**(Features and appearance of baskets and cutlery baskets may vary from your model.)**

Place objects in the dishwasher in the following way:

Items such as cups, glasses, pots, pans, etc. must face downwards.

Curved items, or ones with recesses, should be loaded aslant so that water can run off.

All utensils are stacked securely and can not tip over.

All utensils are placed in the way that the spray arms can rotate freely during washing.

Load hollow items such as cups, glasses, pans etc. With the opening facing downwards so that water cannot collect in the container or a deep base.

Dishes and items of cutlery must not lie inside one another, or cover each other.

To avoid damage, glasses should not touch one another.

The upper basket is designed to hold more delicate and lighter dishware such as glasses, coffee and tea cups.

Long bladed knives stored in an upright position are a potential hazard!

Long and sharp items of cutlery such as carving knives must be positioned horizontally in the upper basket.

Please do not overload your dishwasher. This is important for good results and for reasonable consumption of energy.

### NOTE

Very small items should not be washed in the dishwasher as they could easily fall out of the basket.

## Removing the dishes

To prevent water dripping from the upper basket into the lower basket, we recommend that you empty the lower basket first, followed by the upper basket.

### WARNING



**Items will be hot!** To prevent damage, do not take glass and cutlery out of the dishwasher for around 15 minutes after the program has ended.

## Loading the upper basket

The upper basket is designed to hold more delicate and lighter dishware such as glasses, coffee and tea cups and saucers, as well as plates, small bowls and shallow pans (as long as they are not too dirty). Position the dishes and cookware so that they will not get moved by the spray of water.



## Loading the lower basket

We suggest that you place large and difficult to clean items into the lower basket: such as pots, pans, lids, serving dishes and bowls, as shown in the figure below. It is preferable to place serving dishes and lids on the side of the racks in order to avoid blocking the rotation of the top spray arm.

The maximum diameter advised for plates in front of the detergent dispenser is of 19 cm, this not to hamper the opening of it.

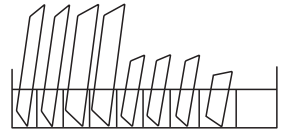

## Loading the cutlery basket

Cutlery should be placed in the cutlery basket separate from each other in the appropriate positions. Avoid nesting of the cutlery to prevent insufficient cleaning performance.

### WARNING



**Do not let any item extend through the bottom.**  
**Always load sharp utensils with the sharp point down!**

# LOADING THE BASKETS ACCORDING TO AS/NZS 2007.1:

## 1.Upper basket:

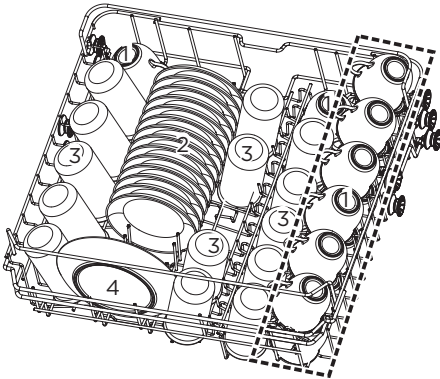

Number	Item
1	Cups
2	Saucers
3	Glasses
4	Dessert dishes

**NOTE:**

Please place the light flat wares on the rack. The total weight is less than 1.5kg.

## 2.Lower basket:

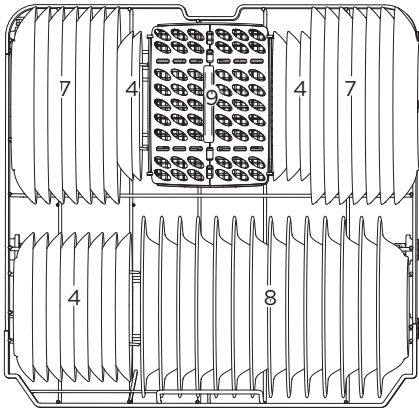

Number	Item
7	Dinner plates
	Soup plates
9	Cutlery basket

### 3. Cutlery rack:

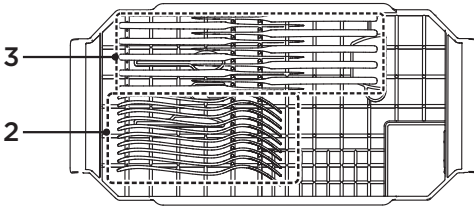

### 4. Cutlery basket:

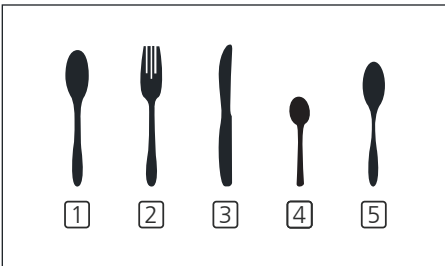
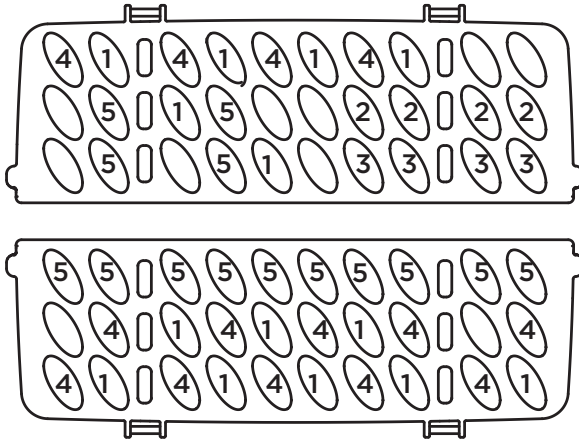

Number	Item
1	Soup spoons
2	Forks
3	Knives
4	Teaspoons
5	Dessert spoons

Information for comparability tests in accordance with (\*AS/NZS 2007.1 )

Capacity: 14 place settings

Position of the upper basket: lower position

Program: ECO

Rinse aid setting: 6

Detergent(Pre/main): 5g/27.5g

Door is open at the end of the drying cycle for the drying performance test

(Door position: Open 50 mm)

## Basket Loading Tips

### Adjusting the upper basket

The height of the upper basket can be easily adjusted to accommodate taller dishes in either the upper or lower basket.

To adjust the height of the upper rack, follow these steps:

1. Pull out the upper basket.

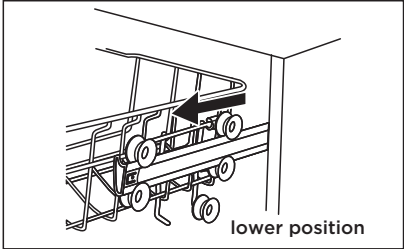

2. Remove the upper basket.

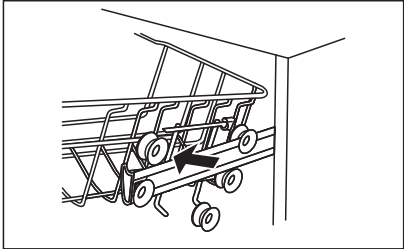

3. Re-attach the upper basket to upper or lower rollers.

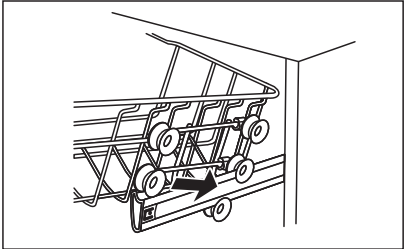

4. Push in the upper basket.

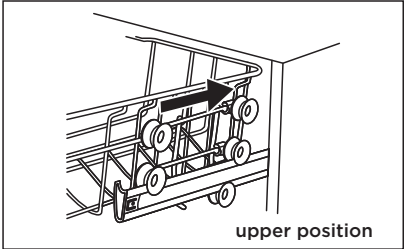

### Sliding cutlery rack

The cutlery rack can slide to the right or left at will.

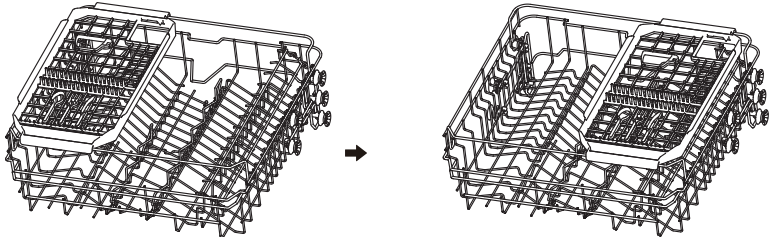

### Folding back the cup shelves

To make room for taller items in the upper basket, raise the cup rack upwards. You can then lean the tall glasses against it.

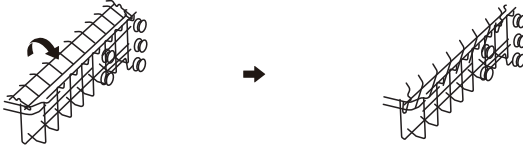

### Folding back the rack shelves

The spikes of the lower basket are used for holding plates and a platter. They can be lowered to make more room for large items.

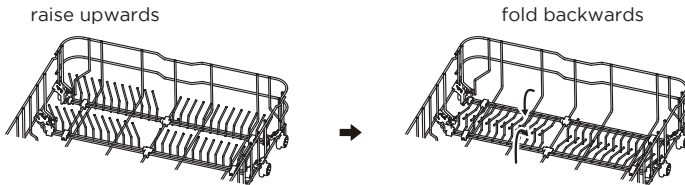

## Function Of The Rinse Aid And Detergent

The rinse aid is released during the final rinse to prevent water from forming droplets on your dishes, which can leave spots and streaks. It also improves drying by allowing water to roll off the dishes. Your dishwasher is designed to use liquid rinse aids.

### **⚠ WARNING**

**Only use branded rinse aid for dishwasher. Never fill the rinse aid dispenser with any other substances (e.g. Dishwasher cleaning agent, liquid detergent). This would damage the appliance.**

#### When to refill the rinse aid

Unless the rinse-aid warning light (  ) on the control panel is on, you can always estimate the amount from the color of the optical level indicator located next to the cap. When the rinse-aid container is full, the indicator will be fully dark. The size of the dark dot decreases as the rinse-aid diminishes. You should never let the rinse aid level be less than 1/4 full.

As the rinse aid diminishes, the size of the black dot on the rinse aid level indicator changes, as illustrated below.

Full       3/4 full       1/2 full       1/4 full       Empty

#### Function of detergent

The chemical ingredients that compose the detergent are necessary to remove, crush and dispense all dirt out of the dishwasher. Most of the commercial quality detergents are suitable for this purpose.

### **⚠ WARNING**

#### Proper Use of Detergent

**Use only detergent specifically made for dishwashers use. Keep your detergent fresh and dry.**

**Do not fill detergent into the dispenser until you are ready to start the dishwasher.**



**Dishwasher detergent is corrosive! Keep dishwasher detergent out of the reach of children.**

## Filling The Rinse Aid Reservoir

1. Remove the rinse aid reservoir cap by rotating it counterclockwise.

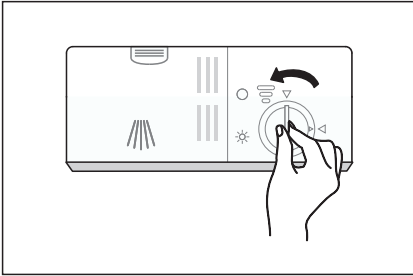

2. Carefully pour in the rinse aid into the dispenser, whilst avoiding it to overflow.

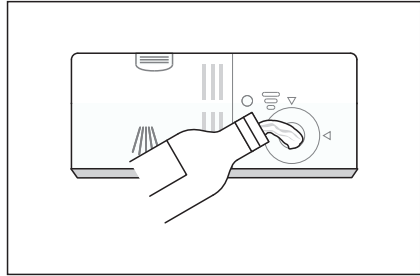

3. Close the rinse aid reservoir cap by rotating it clockwise.

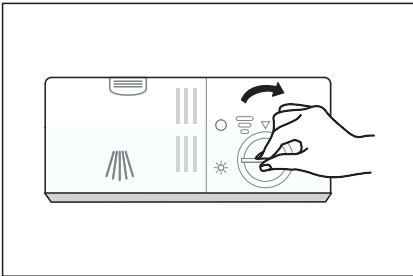

## Adjusting the rinse aid reservoir

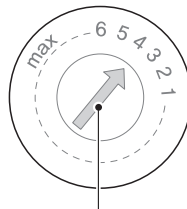
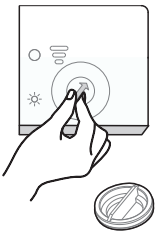

Adjust lever(Rinse)

Turn the rinse aid indicator dial to a number. The higher the number, the more rinse aid the dishwasher uses.

If the dishes are not drying properly or are spotted, adjust the dial to the next higher number until your dishes are spot-free. Reduce it if there are sticky whitish stains on your dishes or a bluish film on glassware or knife blades.

## Filling The Detergent Dispenser

1. Press the release latch on the detergent dispenser to open the cover.

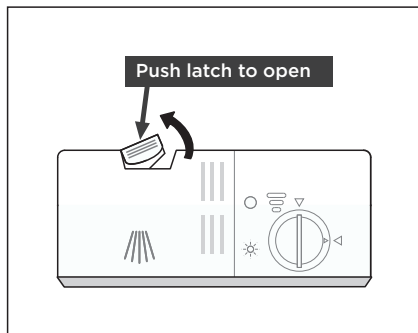

2. Add detergent into the larger cavity (A) for main wash. For more heavily soiled wash loads, also add some detergent into the smaller cavity (B) for release during pre-wash.

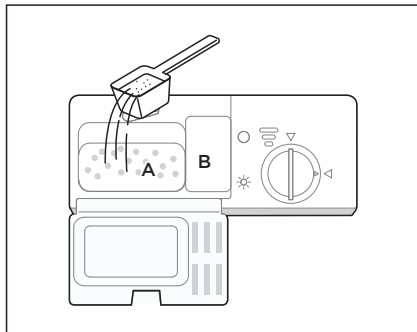

3. Close the cover and press on it until it locks into place.

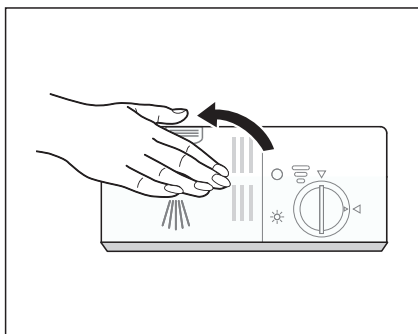

### NOTE

Please observe the manufacturer's recommendations on the detergent packaging.

## Saving Energy

1. Pre-rinsing of tableware items leads to increased water and energy consumption and is not recommended.
2. Washing tableware in a household dishwasher usually consumes less energy and water in the use phase than hand dishwashing when the household dishwasher is used according to the instructions.

## Starting A Program

1. Draw out the lower and upper basket, load the dishes and push them back. It is commended to load the lower basket first, then the upper one.
2. Pour in the detergent.
3. Insert the plug into the socket. The power supply refer to last page "Product fiche". Make sure that the water supply is turned on to full pressure.
4. Close the door, press the Power button.
5. Choose a program, the response light will turn on. Then press the Start/Pause button, the dishwasher will start its cycle after a few seconds.

## Changing The Program Mid-cycle

A program can only be changed if it has been running only for a short period of time, otherwise the detergent may have already been released or the the wash water with detergent has already been drained. If this is the case, the dishwasher needs to be reset and the detergent dispenser must be refilled. To reset the dishwasher, follow the instructions below:

1. Press the Start/Pause button to pause the washing.
2. Press Program button more than three seconds the machine will be in program selection mode.
3. You can change the program to the desired cycle setting.
4. Press the Start/Pause button , the dishwasher will start.

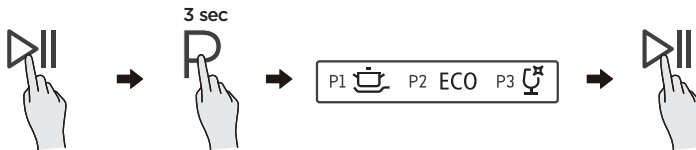

## Forget To Add A Dish?

A forgotten dish can be added any time before the detergent dispenser opens. If this is the case, follow the instructions below:

1. Press the Start/Pause button to pause the washing.
2. After the spray arms stopped working, you can open the door completely.
3. Add the forgotten dishes.
4. Close the door.
5. Press the Start/Pause button, the dishwasher will continued to run.

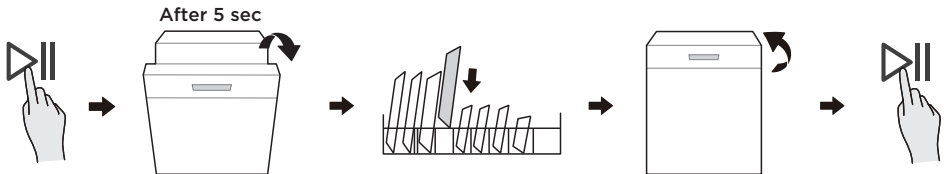

### **⚠ WARNING**

**It is dangerous to open the door mid-cycle, as hot steam may scald you.**

# CLEANING AND MAINTENANCE

## External Care

### The door and the door seal

Clean the door seals regularly with a soft damp cloth to remove food deposits. When the dishwasher is being loaded, food and drink residues may drip onto the sides of the dishwasher door. These surfaces are outside the wash cabinet and are not accessed by water from the spray arms. Any deposits should be wiped off before the door is closed.

### The control panel

If cleaning is required, the control panel should be wiped with a soft damp cloth only.

### **⚠ WARNING**

To avoid penetration of water into the door lock and electrical components, do not use a spray cleaner of any kind.

Never use abrasive cleaners or scouring pads on the outer surfaces because they may scratch the finish. Some paper towels may also scratch or leave marks on the surface.

## Internal Care

### Filtering system

The filtering system in the base of the wash cabinet retains coarse debris from the washing cycle, including foreign objects such as tooth picks or shards. The collected coarse debris may cause the filters to clog. Check the condition of the filters regularly, carefully remove foreign objects and clean the parts of the filtering system if necessary with water. Follow the steps below to clean the filter.

### **⚠ WARNING**

Pictures are only for reference, different models of the filtering system and spray arms may be different.

1. Hold the coarse filter and rotate it anticlockwise to unlock the filter. Lift the filter upwards and out of the dishwasher.

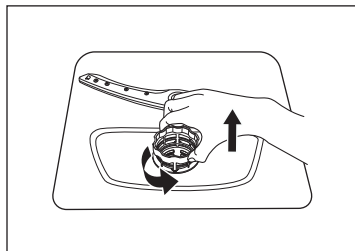

2. The fine filter can be pulled off the bottom of the filter assembly. The coarse filter can be detached from the main filter by gently squeezing the tabs at the top and pulling it away.

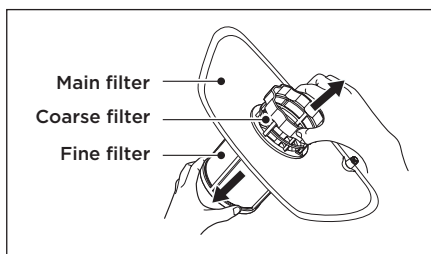

3. Larger food remnants can be cleaned by rinsing the filter under running water. For a more thorough clean, use a soft cleaning brush.

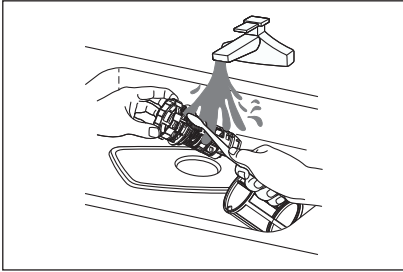

4. Reassemble the filters in the reverse order of the disassembly, replace the filter insert, and rotate clockwise to the close arrow.

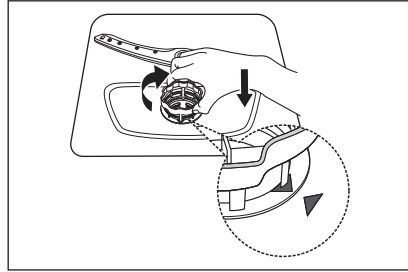

### **▲ WARNING**

Do not over tighten the filters. Put the filters back in sequence securely, otherwise coarse debris could get into the system and cause a blockage. Never use the dishwasher without filters in place. Improper replacement of the filter may reduce the performance level of the appliance and damage dishes and utensils.

## **Spray arms**

It is necessary to clean the spray arms regularly for hard water chemicals will clog the spray arm jets and bearings.

To clean the spray arms, follow the instructions below:

1. To remove the upper spray arm, hold the nut, rotate the arm clockwise to remove it.
2. To remove the lower spray arm, pull out the spray arm upward.

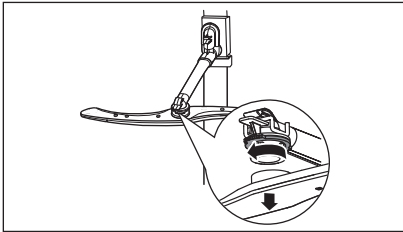

3. Wash the arms in soapy and warm water and use a soft brush to clean the jets. Replace them after rinsing them thoroughly.

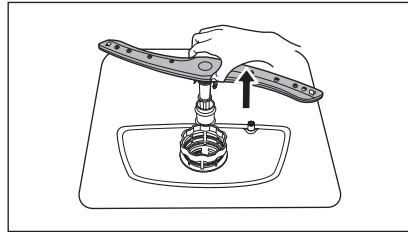
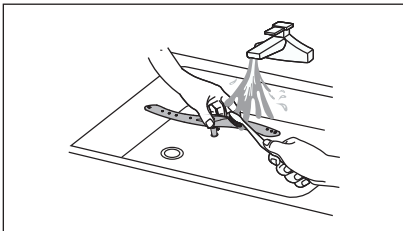

## **Caring For The Dishwasher**

### **Frost precaution**

Please take frost protection measures on the dishwasher in winter. Every time after washing cycles, please operate as follows:

1. Cut off the electrical power to the dishwasher at the supply source.
2. Turn off the water supply and disconnect the water inlet pipe from the water valve.
3. Drain the water from the inlet pipe and water valve. (Use a pan to gather the water)
4. Reconnect the water inlet pipe to the water valve.
5. Remove the filter at the bottom of the tub and use a sponge to soak up water in the sump.

### **After every wash**

After every wash, turn off the water supply to the appliance and leave the door slightly open for a while so that moisture and odors are not trapped inside.

### **Remove the plug**

Before cleaning or performing maintenance, always remove the plug from the socket.

### **No solvents or abrasive cleaning**

To clean the exterior and rubber parts of the dishwasher, do not use solvents or abrasive cleaning products. Only use a cloth with warm soapy water.

To remove spots or stains from the surface of the interior, use a cloth dampened with water and a little vinegar, or a cleaning product made specifically for dishwashers.

### **When not in use for a long time**

It is recommended that you run a wash cycle with the dishwasher empty and then remove the plug from the socket, turn off the water supply and leave the door of the appliance slightly open. This will help the door seals to last longer and prevent odors from forming within the appliance.

### **Moving the appliance**

If the appliance must be moved, try to keep it in the vertical position. If absolutely necessary, it can be positioned on its back.

### **Seals**

One of the factors that cause odours to form in the dishwasher is food that remains trapped in the seals. Periodic cleaning with a damp sponge will prevent this from occurring.

# TROUBLESHOOTING

## Before Calling For Service

Reviewing the charts on the following pages may save you from calling for service.

Problem	Possible reason	Solution
Dishwasher doesn't start	<ul style="list-style-type: none"> <li>Fuse blown, or the circuit break tripped.</li> </ul>	Replace fuse or reset circuit breaker. Remove any other appliances sharing the same circuit with the dishwasher.
	<ul style="list-style-type: none"> <li>Power supply is not turned on.</li> </ul>	Make sure the dishwasher is turned on and the door is closed securely. Make sure the power cord is properly plugged into the wall socket.
	<ul style="list-style-type: none"> <li>Water pressure is low</li> </ul>	Check that the water supply is connected properly and the water is turned on.
	<ul style="list-style-type: none"> <li>Door of dishwasher not properly closed.</li> </ul>	Make sure to close the door properly and latch it.
Water not pumped form dishwasher	<ul style="list-style-type: none"> <li>Twisted or trapped drain hose.</li> </ul>	Check the drain hose.
	<ul style="list-style-type: none"> <li>Filter clogged.</li> </ul>	Check the filter system.
	<ul style="list-style-type: none"> <li>Kitchen sink clogged.</li> </ul>	Check the kitchen sink to make sure it is draining well. If the problem is the kitchen sink that is not draining , you may need a plumber rather than a serviceman for dishwashers.
Foam in the tub	<ul style="list-style-type: none"> <li>Wrong detergent.</li> </ul>	Use only the special dishwasher detergent to avoid suds. If this occurs, open the dishwasher and let suds evaporate. Add 1 liter of cold water to the bottom of the dishwasher. Close the dishwasher door, then select any cycle. Initially, the dishwasher will drain out the water. Open the door after draining stage is complete and check if the suds have disappeared. Repeat if necessary.
Stained tub interior	<ul style="list-style-type: none"> <li>Spilled rinse aid.</li> </ul>	Always wipe up rinse aid spills immediately.
	<ul style="list-style-type: none"> <li>Detergent with colourant may have been used.</li> </ul>	Make sure that the detergent has no colourant.

Problem	Possible reason	Solution
There are rust stains on cutlery	<ul style="list-style-type: none"> <li>The affected items are not corrosion resistant.</li> </ul>	Avoid washing items that are not corrosion resistant in the dishwasher.
	<ul style="list-style-type: none"> <li>A program was not run after dishwasher salt was added. Traces of salt have gotten into the wash cycle.</li> </ul>	Always run a wash program without any crockery after adding salt. Do not select the Turbo function (if present), after adding dishwasher salt.
	<ul style="list-style-type: none"> <li>The lid of the softer is loose.</li> </ul>	Check the softener lid is secure.
Knocking noise in the dishwasher	<ul style="list-style-type: none"> <li>A spray arm is knocking against an item in a basket</li> </ul>	Interrupt the program and rearrange the items which are obstructing the spray arm.
Rattling noise in the dishwasher	<ul style="list-style-type: none"> <li>Items of crockery are loose in the dishwasher.</li> </ul>	Interrupt the program and rearrange the items of crockery.
Knocking noise in the water pipes	<ul style="list-style-type: none"> <li>This may be caused by on-site installation or the cross-section of the piping.</li> </ul>	This has no influence on the dishwasher function. If in doubt, contact a qualified plumber.
The dishes are not clean	<ul style="list-style-type: none"> <li>The dishes were not loaded correctly.</li> <li>The program was not powerful enough.</li> </ul>	See the "Preparing And Loading Dishes".  Select a more intensive program.
	<ul style="list-style-type: none"> <li>Not enough detergent was dispensed.</li> </ul>	Use more detergent, or change your detergent.
	<ul style="list-style-type: none"> <li>Items are blocking the movement of the spray arms.</li> </ul>	Rearrange the items so that the spray can rotate freely.
	<ul style="list-style-type: none"> <li>The filter combination is not clean or is not correctly fitted in the base of wash cabinet. This may cause the spray arm jets to get blocked.</li> </ul>	Clean and/or fit the filter correctly. Clean the spray arm jets.
Cloudiness on glassware.	<ul style="list-style-type: none"> <li>Combination of soft water and too much detergent.</li> </ul>	Use less detergent if you have soft water and select a shorter cycle to wash the glassware and to get them clean.
White spots appear on dishes and glasses.	<ul style="list-style-type: none"> <li>Hard water area can cause limescale deposits.</li> </ul>	Check water softener settings or fill status of salt container.

Problem	Possible reason	Solution
Black or grey marks on dishes	<ul style="list-style-type: none"> <li>Aluminium utensils have rubbed against dishes</li> </ul>	Use a mild abrasive cleaner to eliminate those marks.
Detergent left in dispenser	<ul style="list-style-type: none"> <li>Dishes block detergent dispenser</li> </ul>	Re-loading the dishes properly.
The dishes aren't drying	<ul style="list-style-type: none"> <li>Improper loading</li> </ul>	Use gloves if detergent residue can be found on dishes to avoid skin irritations.
	<ul style="list-style-type: none"> <li>Dishes are removed too soon</li> </ul>	Do not empty your dishwasher immediately after washing. Open the door slightly so that the steam can come out. Take out the dishes until the inside temperature is safe to touch. Unload the lower basket first to prevent the dropping water from the upper basket.
	<ul style="list-style-type: none"> <li>Wrong program has been selected.</li> </ul>	With a short program, the washing temperature is lower, decreasing cleaning performance. Choose a program with a long washing time.
	<ul style="list-style-type: none"> <li>Use of cutlery with a low-quality coating.</li> </ul>	Water drainage is more difficult with these items. Cutlery or dishes of this type are not suitable for washing in the dishwasher.

## WARNING

Self-repair or non-professional repair may cause serious risks to the safety of the user of the appliance and impact warranty.

## Availability Of Spare Parts

- Seven years after placing the last unit of the model on the market:  
Motor, circulation and drain pump, heaters and heating elements, including heat pumps (separately or bundled), piping and related equipment including all hoses, valves, filters and aqua stops, structural and interior parts related to door assemblies (separately or bundled), printed circuit boards, electronic displays, pressure switches, thermostats and sensors, software and firmware including reset software.
- Ten years after placing the last unit of the model on the market:  
Door hinge and seals, other seals, spray arms, drain filters, interior racks and plastic peripherals such as baskets and lids.

## ERROR CODES

If there is a malfunction the dishwasher will display an error code. The following table shows possible error codes and their causes.

Problem	Possible reason	Solution
E1	<ul style="list-style-type: none"><li>• Longer inlet time.</li></ul>	Faucets is not opened, or water intake is restricted, or water pressure is too low.
E3	<ul style="list-style-type: none"><li>• Not reaching required temperature.</li></ul>	Malfunction of heating element.
E4	<ul style="list-style-type: none"><li>• Overflow.</li></ul>	Some element of dishwasher leaks.
Ed	<ul style="list-style-type: none"><li>• Failure of communication between main circuit board with display circuit board.</li></ul>	Open circuit or break wiring for the communication

### WARNING

- If overflow occurs, turn off the main water supply before calling a service.
- If there is water in the base pan because of an overfill or small leak, the water should be removed before restarting the dishwasher.
- If there is an error code that cannot be solved, please request professional assistance.

# TRADEMARKS, COPYRIGHTS AND LEGAL STATEMENT

 Midea logo, word marks, trade name, trade dress and all versions thereof are valuable assets of Midea Group and/or its affiliates (“Midea”), to which Midea owns trademarks, copyrights and other intellectual property rights, and all goodwill derived from using any part of an Midea trademark. Use of Midea trademark for commercial purposes without the prior written consent of Midea may constitute trademark infringement or unfair competition in violation of relevant laws.

This manual is created by Midea and Midea reserves all copyrights thereof. No entity or individual may use, duplicate, modify, distribute in whole or in part this manual, or bundle or sell with other products without the prior written consent of Midea.

All the described functions and instructions were up to date at the time of printing this manual. However, the actual product may vary due to improved functions and designs.

# DISPOSAL AND RECYCLING

## Important instructions for environment

Compliance with the WEEE Directive and Disposing of the Waster Product:  
This product complies with EU WEEE Directive (2012/19/EU). This product bears a classification symbol for waster electrical and electronic equipment (WEEE).

This symbol indicates that this product shall not be disposed with other household wastes at the end of its service life. Used device must be returned to official collection point for recycling of electrical electronic devices. To find these collection systems please contact to your local authorities or retailer where the product was purchased. Each household performs important role in recovering and recycling of old appliance. Appropriate disposal of used appliance helps prevent potential negative consequences for the environment and human health.

## Compliance with RoHS Directive

The product you have purchased complies with EU RoHS Directive (2011/65/EU). It does not contain harmful and prohibited materials specified in the Directive.

## Package information

Packaging materials of the product are manufactured from recyclable materials in accordance with our National Environment Regulations. Do not dispose of the packaging materials together with the domestic or other wastes. Take them to the packaging material collection points designated by the local authorities.

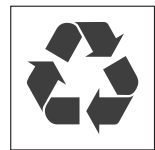

# DATA PROTECTION NOTICE

For the provision of the services agreed with the customer, we agree to comply without restriction with all stipulations of applicable data protection law, in line with agreed countries within which services to the customer will be delivered, as well as, where applicable, the EU General Data Protection Regulation (GDPR).

Generally, our data processing is to fulfil our obligation under contract with you and for product safety reasons, to safeguard your rights in connection with warranty and product registration questions. In some cases, but only if appropriate data protection is ensured, personal data might be transferred to recipients located outside of the European Economic Area.

Further information are provided on request. You can contact our Data Protection Officer via **MideaDPO@midea.com**. To exercise your rights such as right to object your personal data being processed for direct marketing purposes, please contact us via **MideaDPO@midea.com**. To find further information, please follow the QR Code.



*make yourself at home*



[www.midea.com](http://www.midea.com)



此红框内丝印此用户手册对应的14位物料编码生成的128码 红色框不需印刷  
字体为Gotham-Book 8pt 位置大小严格按图纸操作