



**CHI Q**

**CHI Q**

# ▶ **USER MANUAL**

Customer Service

**1300 796 688**

[www.chiq.com.au](http://www.chiq.com.au)

MODEL

**U75QM10**

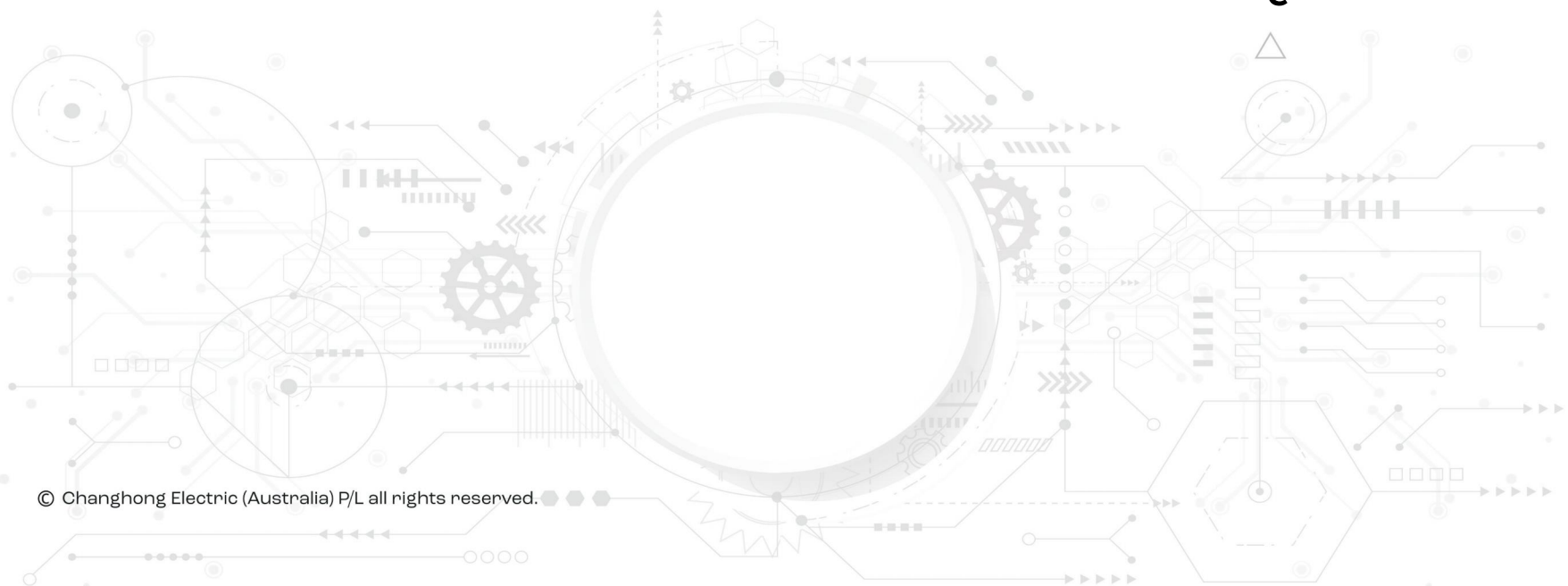

© Changhong Electric (Australia) P/L all rights reserved.



# Table of contents

Table of contents .....	1
Stability Hazard .....	1
Safety instructions .....	5
After use .....	7
Getting started.....	8
Controls and connections .....	10
Connecting antenna, Internet and external devices .....	12
Initial Setup .....	14
Basic TV instructions .....	15
Accessing Smart TV Homepage .....	16
Help function .....	17
USB FUNCTION (Media Player) .....	17
PVR(Personal Video Recorder) .....	18
Bluetooth Function .....	18
Google Assistant .....	19
Chromecast Built-in .....	19
Trouble-shooting .....	21
Wall-mounting .....	23

## Stability Hazard

The television set may fall, causing serious personal injury or death. Never place a television set in an unstable location, A television set may fall, causing serious personal injury or death. Many injuries, particularly to children, can be avoided by taking simple precautions such as:

- ALWAYS use cabinets or stands or mounting methods recommended by the manufacturer of the television set.
- ALWAYS use furniture that can safely support the television set.
- ALWAYS ensure the television set is not overhanging the edge of the supporting furniture.
- ALWAYS educate children about the dangers of climbing on furniture to reach the television set or its controls.
- ALWAYS route cords and cables connected to your television so they cannot be tripped over, pulled or grabbed.
- NEVER place a television set in an unstable location.
- NEVER place the television set on tall furniture (for example, cupboards or bookcases) without anchoring both the furniture and the television set to a suitable support.
- NEVER place the television set on cloth or other materials that may be located between the television set and supporting furniture.
- NEVER place items that might tempt children to climb, such as toys and remote controls, on the top of the television or furniture on which the television is placed.

If your existing television set is being retained and relocated. The same consider actions as above should be applied.

To prevent injury, this television set must be securely attached to the floor/wall in accordance with the installation instructions.

**NOTE:** The power consumption might increase if TV is turned into standby when it is in Apps or network function mode. It will be stabilized in 30 minutes. Alternatively press and hold power button on remote for 3 seconds, TV will go into fully standby and close all functions.

# Warning

## DEAR CUSTOMER:

Before operating, please read all these safety and operating instructions completely and then retain this manual for future reference. Always comply with the following precautions to avoid dangerous situations and ensure peak performance of your product.



### WARNING:

TO REDUCE THE RISK OF ELECTRIC SHOCK DO NOT REMOVE COVER (OR BACK). NO USER SERVICEABLE PARTS INSIDE. REFER TO QUALIFIED SERVICE PERSONNEL.



The lightning flash with arrowhead symbol, within an equilateral triangle is intended to alert the user to the presence of uninsulated “dangerous voltage” within the products enclosure that may be of sufficient magnitude to constitute a risk of electric shock.



The exclamation point within an equilateral triangle is intended to alert the user to the presence of important operating and maintenance (servicing) instructions in the literature accompanying the appliance.

## REGULATORY INFORMATION

This equipment generates uses and can radiate radio frequency energy and, if not installed and used in accordance with the instructions, may cause harmful interference to radio communication. However, there is no guarantee that interference will not occur in a particular installation. If this equipment does cause harmful interference to radio or television reception, which can be determined by turning the equipment off and on, the user is encouraged to try to correct the interference by one or more of the following measures:

- a. Relocate the receiving antenna.
- b. Increase the separation between the equipment and receiver.
- c. Connect the equipment into an outlet on a circuit different from that to which the receiver is connected.
- d. Consult the dealer or experienced radio/TV technician for help.

### CAUTION

※ **Do not attempt to modify this product in any way without written authorization from supplier. Unauthorized modification could void the user's authority to operate this product.**

※ **Figures and illustrations in this User Manual are provided for reference only and may differ from actual product appearance. Product design and specifications may be changed without notice.**

# Warning

## IMPORTANT WARNINGS AND CAUTIONS!

Electrical energy can perform many useful functions, but it can also cause personal injuries and property damage if improperly handled. This product has been engineered and manufactured with the highest priority on safety. BUT IMPROPER USE CAN RESULT IN POTENTIAL ELECTRICAL SHOCK OR FIRE HAZARD. In order to prevent potential danger, please observe the following instructions when installing, operating and cleaning the product.

- 1. Attachments** --- Only use attachments/accessories specified by the manufacturer. Do not use attachments not recommended by the manufacturer. Use of improper attachments can result in accidents.
- 2. Water** --- To reduce the risk of fire or electric shock, do not expose this apparatus to rain or moisture. The apparatus shall not be exposed to dripping or splashing and that objects filled with liquids, such as vases, shall not be placed on apparatus.
- 3. Fire or explosion** --- Do not use or store flammable or combustible materials near the unit. Doing so may result in fire or explosion. Do not place any naked flame sources, such as lit candles, cigarettes or incense sticks on top of the TV set.  
**Warning:** To prevent the spread of fire, keep candles or other open flames away from this product at all times.
- 4. Ventilation** --- When you install your TV, maintain a distance of at least 4 inches between the TV and other objects (walls, cabinet sides, etc.) to ensure proper ventilation. Failing to maintain proper ventilation may result in a fire or a problem with the product caused by an increase in its internal temperature.
- 5.**  This equipment is a Class II or double insulated electrical appliance. It has been designed in such a way that it does not require a safety connection to electrical earth.
- 6. Power source** --- This product is intended to be supplied by a listed power supply indicated on the marking label. If you are not sure of the type of power supply to your home, consult your product dealer or local power company.
- 7. Overloading** --- Do not overload wall outlets, extension cables, or convenience receptacles on other equipment as this can result in a risk of fire or electric shock.
- 8. Voltage** --- Before installing this TV set, make sure your outlet voltage corresponds to the voltage stated on the appliance rating label.
- 9. Power plug** --- Do not defeat the safety purpose of the polarized or grounding-type plug. Most appliances recommend they be placed upon a dedicated circuit; that is, a single outlet circuit which powers only that appliance and has no additional outlets or branch circuits.
- 10.** The MAINS plug of the apparatus is used as the disconnect device, the disconnect device shall remain readily operable. Keep you AC powersocket close to you TV for easy plugging and unplugging.

# Warning

- 11. Wall mounting** --- When mounting the product on a wall, be sure to install the product according to the method recommended by the manufacturer. This is a safety feature.
- 12. Stand** --- Do not place the product on an unstable trolley, stand, tripod or table. Placing the product on an unstable base can cause the product to fall, resulting in serious personal injuries as well as damage to the product. Always place the TV on furniture that can safely support the TV. Make sure the ends of the TV do not overhang the edge of the supporting furniture.
- 13. Entering of objects and liquids** --- Never insert an object into the product through vents or openings. High voltage flows in the product, and inserting an object can cause electric shock and/or short internal parts. For the same reason, do not spill water or liquid on the product.
- 14. Damage requiring service** --- This unit should only be serviced by an authorized and properly trained technician. Opening the cover or other attempts by the user to service this unit may result in serious injury or death from electrical shock, and may increase the risk of fire.
- 15. Replacement parts**---In case the product needs replacement parts, make sure that the service person uses replacement parts specified by the manufacturer, or those with the same characteristics and performance as the original parts. Use of unauthorized parts can result in fire, electric shock and/or other danger.
- 16. Safety checks** --- Upon completion of service or repair work, request the service technician to perform safety checks to ensure that the product is in proper operating condition.
- 17. Children** --- Do not allow young children to play with the plastic bag that came with the television when you unpacked it. Failure to do so can result in suffocation, causing injury.
- 18. Batteries** --- The batteries (battery pack or batteries installed) shall not be exposed to excessive heat such as sunshine, fire or the like.  
Do not dispose of any batteries in with the domestic waste. Return them to a collection point for old batteries.
- 19. Antenna** --- Install the antenna away from high-voltage power lines and communication cables and make sure it is installed securely. If the antenna touches a power line, contact with the antenna could result in fire, electric shock or serious injury.
- 20. Panel protection** --- The panel used in this product is made of glass. Therefore, it can break when the product is dropped or impacted upon by other objects. Be careful not to be injured by broken glass pieces in case the panel breaks.
- 21. Operating Temperature:** 5°C to 45°C    **Operating Humidity:** ≤80%  
**Storage Temperature:** -15°C to 45°C    **Storage Humidity:** ≤90%

# Safety Instructions

## IMPORTANT SAFETY INSTRUCTIONS

1. Read these instructions.
2. Keep these instructions.
3. Heed all warnings.
4. Follow all instructions.
7. Do not block any ventilation openings. Install in accordance with the manufacturer's instructions.

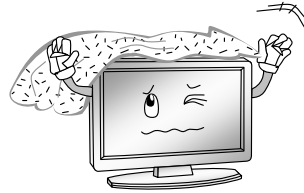
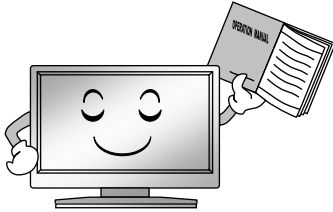

5. Do not use this apparatus near water.

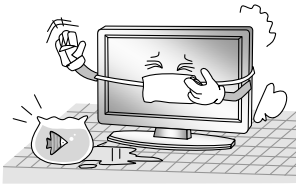

8. Do not install near any heat source such as radiators, heat registers, stoves, or other apparatus (including amplifiers) that produce heat.

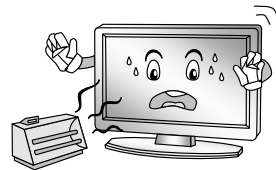

6. Clean only with a dry cloth.

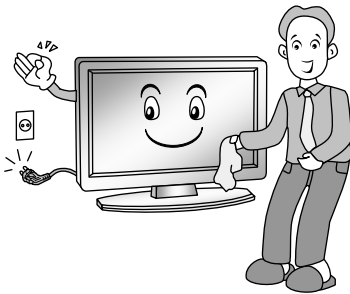

9. Do not defeat the safety purpose of the polarized or grounding type plug. A polarized plug has two blades with one wider than other. A grounding type plug has two blades and a third grounding prong. The wide blade or the third prong is provided for your safety. When the provided plug does not fit into your outlet, consult an electrician for replacement of the obsolete outlet.

# Safety Instructions

10. Protect the power cord from being walked on or pinched particularly at plugs, convenience receptacles, and the point where they exit from the apparatus.



13. Unplug this apparatus during lightning storms or when unused for long periods of time.



11. Only use the attachments / accessories specified by the manufacturer.

12. Use only with a cart, stand, tripod, bracket, or table specified by the manufacturer, or sold with the apparatus. When a cart is used, use caution when moving the cart/apparatus combination to avoid injury from tip.



14. Refer all servicing to qualified service personnel. Servicing is required when the apparatus has been damaged in any way, such as power supply cord or plug is damaged, liquid has been spilled or objects have fallen into the apparatus, the apparatus has been exposed to rain or moisture, does not operate normally, or has been dropped.



## NOTE:

- ◆ Disposal of this product must be carried out in accordance to the regulations of your local authority. Do not dispose of this product with general household waste disposal.
- ◆ Occasionally, a few non-active pixels may appear on the screen as a fixed point of blue, green or red. Please note that this does not affect the performance of your product.
- ◆ Avoid touching the screen or holding your finger(s) against it for long periods of time. Doing so may produce some temporary distortion effect on the screen.
- ◆ It is not recommended to keep a certain still image displayed on the screen for a long time as well as displaying extremely bright images on screen, reduce the 'brightness' and 'contrast' when displaying still images.

## Intended use of the product

This is a consumer electronics device. It is used to receive TV via an antenna or cable TV network and to play back multimedia files from the Internet and USB mass storage devices. It may only be used for private purposes and not for industrial or commercial applications. It is not intended for medical, life-saving or life-preserving applications.

Only use connecting cables and external devices which are compatible with the product in terms of safety, electromagnetic compatibility and shielding.

Only use accessories recommended by the manufacturer. Do not use this device for purposes other than those indicated and do not modify it in any way. Always comply with the regulations and laws of the country in which you are operating the device.

NOTE:

The range of power input for the TV is 100-240V~ 50/60Hz; do not connect the TV power input port with the power cable out of the above range.

Please hold the insulated part of the plug when you are unplugging the power cable, do not touch directly the metallic part of the cable.

Before connecting to an external device, please firstly make sure that the TV set and the external device have been turned off. When connecting, please make reference to the interface name and the interface color to connect the signal cable.

NOTE:

No matter in what circumstances, please keep the TV panel vertically placed, if any tilt, the tilt angle between panel and vertical plane must not exceed 15° (the rule applies to frameless series product).

## Explanation of other symbols



Dolby, Dolby Vision, Dolby Atmos, and the double-D symbol are registered trademarks of Dolby Laboratories Licensing Corporation. Manufactured under license from Dolby Laboratories. Confidential unpublished works. Copyright © 2012 –2022 Dolby Laboratories. All rights reserved.

~: It Indicates alternating current.

⇨: It Indicates direct current.

## After use

### Cleaning



**Warning:** Make sure the device is unplugged from the mains power before cleaning. Otherwise, there is a risk of electrocution!

Never spill or spray any type of liquid into the unit. Only use a clean, dry cloth for cleaning the casing. Never use aggressive liquids. When very dirty, use a slightly dampened cloth.

Clean the screen with a special cleaning cloth for screens.



**Caution:** when you clean the screen, hold the device steady with one hand and carefully clean the screen with the other. Otherwise, the device could tip over and get damaged or cause injuries.

## Storage when not in use

If you do not plan to use the device for an extended period of time, ensure you follow the below steps

### Powering off

To power the TV off, press and hold the  button on the remote control until the TV shows a message on the screen asking for your confirmation to Power Off. Press OK to close all the open apps and shut down the TV.

Then unplug the power cord from the socket and remove the batteries from the remote control. Make sure that the storage temperature is between -15 °C and 45 °C and the relative humidity does not exceed 90%.

## Transport

If you wish to move the device a short distance, proceed as follows to transport the device:

1. Disconnect the device from the mains.
2. Remove all cables connected to the device.
3. If you wish to move the device outside your building, demount the base and the optional side supports or the mounted wall bracket by reversing the procedure.
4. Pack the TV set up carefully. Take special care to ensure the corners of the casing and the screen are well protected.
5. Take the TV set and its accessories to its new location and recommission it.

## Disposal of old electrical appliances



Old household electrical appliances must not be disposed of in the normal unsorted municipal waste stream. Old appliances must be collected separately in order to optimize the recovery and recycling of the materials they contain, and reduce the impact on human health and the environment.

The crossed out “wheeled bin” symbol on the product reminds you of your obligation, that when you dispose of the appliance, it must be separately collected.

Consumers should contact their local authority or retailer for information concerning the correct disposal of their old appliance.

## Getting started

### Fitting the stand

Before you can install your TV set, you need to fit the stand. Alternatively, you can mount it on the wall. A Phillips screwdriver is needed to perform the installation. Please check stand installation guide in accessory bag.

### Setting up the TV set

Place your TV set on a flat, stable surface (e.g. a table or a specially designed TV stand). Make sure that all cables are laid simply and safely and do not represent a trip hazard. The device must be connected to a mains socket using the mains cable.

This mains socket must be easily accessible so that the mains plug can be removed immediately in the event of an emergency.

## **Fitting the batteries into the remote control**

1. Turn the remote control over with the back facing upwards, put thumb on the top of the battery cover where it has a triangle sign. Push down gently and pull down the cover out of the position.

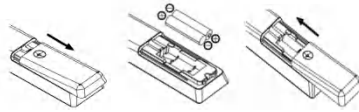

2. Insert the batteries supplied into the remote control. Make sure that you insert the batteries correctly with the polarity as shown inside the battery compartment.
3. Replace the battery compartment cover and push in the opposite direction to the arrow until it clicks into place.

## **Notes on Using Batteries:**

The use of the wrong type of batteries may cause chemical leakage and/or explosion. Please note the following:

Always ensure that the batteries are inserted with the + and - terminals in the correct direction as shown in the battery compartment.

Different types of batteries have different characteristics. Do not mix different types.

Do not mix old and new batteries. Mixing old and new batteries will shorten battery life and/or cause chemical leakage. Replace batteries as soon as they do not work.

Chemicals which leak from batteries may cause skin irritation. If any chemical matter seeps out of the batteries, wipe it up immediately with a dry cloth.

The batteries may have a shorter life expectancy due to storage conditions.

Remove the batteries whenever you anticipate that the remote control will not be used for an extended period.

The batteries (battery pack or batteries installed) shall not be exposed to excessive heat such as sunshine, fire or the like.

## **CAUTION:**

It may result in an explosion if batteries are replaced incorrectly.

Only replace batteries with the same or equivalent type.

# Controls and connections



**Caution:** Before connecting or disconnecting any cables, switch off all related devices (also the TV). Otherwise you could damage the devices.

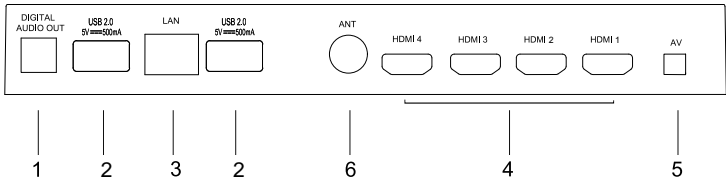
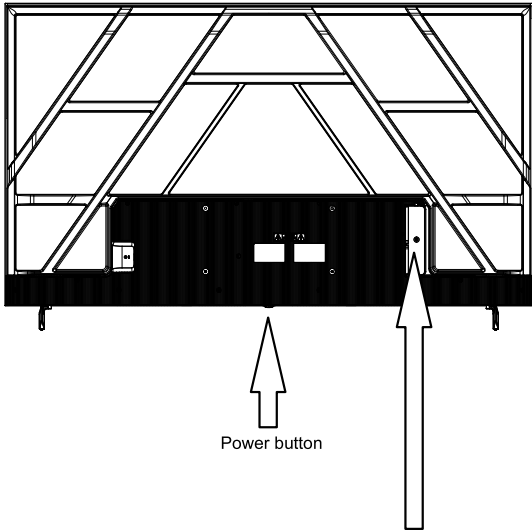

- 1. Digital audio out
- 2. USB 2.0 port
- 3. LAN: Network port
- 4. HDMI ports (HDMI2 supports eARC/ARC function)
- 5. AV
- 6. Antenna socket

## Remote control

Definition of the buttons on remote control:

Buttons	Description
<b>Power</b>	Turn on/off TV
<b>Source</b>	Select signal source
<b>Number</b>	Number buttons
<b>Menu</b>	Display main menu, while on any external input source
<b>Subtitle</b>	Select subtitle.
<b>Account</b>	Switch account
<b>Voice</b>	Activate Voice command Function/Google assist
<b>Dashboard</b>	Displays dashboard Menu
<b>Direction/OK</b>	Press the direction buttons to select menu options or settings. Press OK to select or confirm menu item.
<b>Back</b>	Return to previous menu or setting
<b>Home</b>	Open Google TV Homepage
<b>EPG</b>	Launch Electronic Program Guide
<b>Volume</b>	Adjust the volume
<b>Program</b>	Select programs in ascending or descending order
<b>Mute</b>	Mute or restore sound
<b>Live TV</b>	Access to Live TV channels
<b>NETFLIX</b>	Open NETFLIX App
<b>YouTube</b>	Open YouTube App
<b>Prime video</b>	Open prime video App
<b>APPS</b>	Display all installed applications
<b>USB</b>	Switches to the USB source.
<b>: fYY \ch Ym</b>	7i gha lnYUg Udd g' cflW hg' cf gng'ha Z bWlcb g' cflW hg'
<b>Info</b>	Display program information
<b>Audio</b>	Select audio languages and Audio channels
<b>TTX</b>	Show or hide Teletext
<b>REC</b>	Press ● button to start recording(In DTV mode)
<b>Color</b>	Use in accordance with the Operation interface instructions

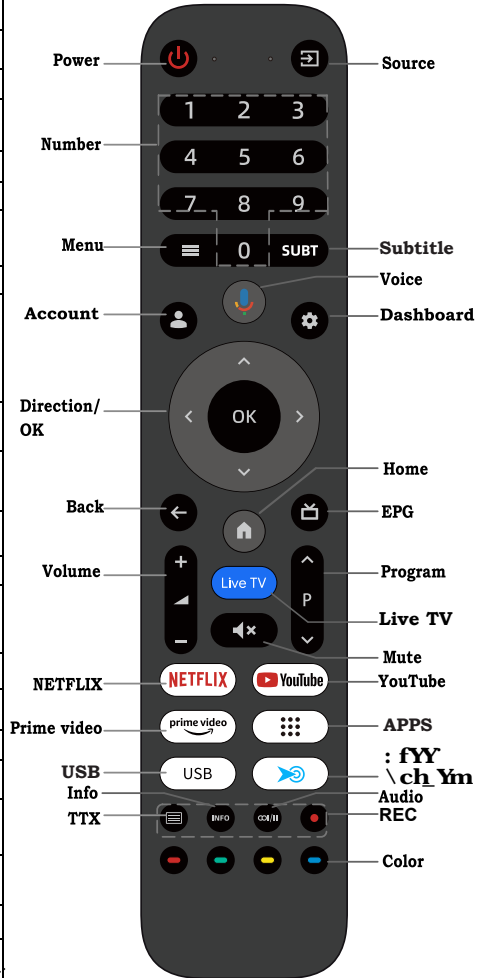

# Connecting antenna, Internet and external devices

## Connecting the TV antenna or cable TV

You can connect the cable from your indoor or outdoor antenna or cable TV to the antenna socket.

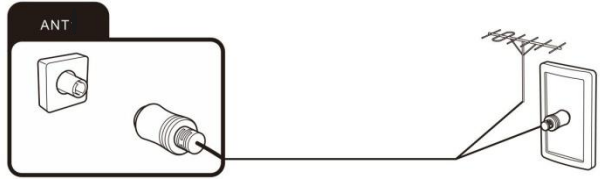

## Connecting the network cable (LAN connection)



You can also establish an internet connection via WiFi.

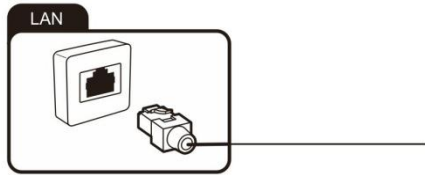

## Connecting external equipment with HDMI interface

HDMI is the abbreviation for "High Definition Multimedia" and allows the digital transmission of both audio video signals over the same cable.

Press **source** button  and select the signal source "HDMI1/2/3/4" accordingly.

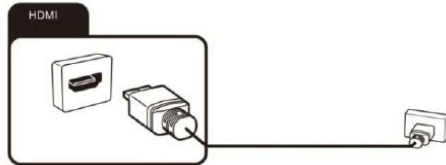

## 120Hz DLG

In DLG working mode, the TV can be compatible with 1080P 120Hz refresh rate display. The open method is:

Enter the corresponding HDMI channel -->setting-- >picture---->advance video-- >DLG mode.

Notes:

- 120Hz DLG is only available at resolution up to 2K(1920 x1080). 4K resolution will only support 60Hz.
- A compatible games console or PC is required, please refer to games console or PC instructions for further information.

## Connecting an external device with AV output

Connect external devices via the AV IN jack directly to TV by using a Mini AV cable.

In order to play the audio and video signal fed in from the external device on the TV,

Press **source** button  and select the signal source "AV".

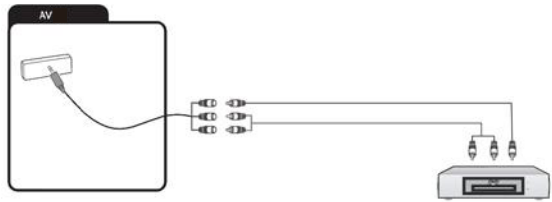

## Connecting a digital audio system

You can connect your TV set to a digital audio system.

Sending the TV's digital audio signal to external audio equipment via the digital audio output port

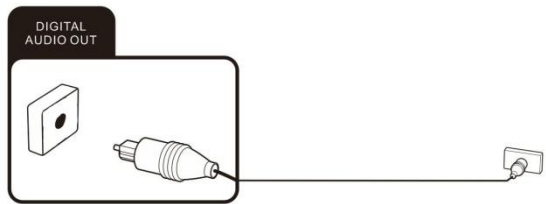

## Connecting USB device

The TV has USB 2.0 ports for connection with appropriate mass storage devices.



## Powering the TV set on and off

### Powering on

Check that the TV is in standby mode. This means the power cable must be connected to a working power point. Then press the power button on the device or the  button on the remote control to turn on the TV.

### Stand-by mode

To put the TV into the stand-by mode, either press the Power button on the back of the TV or press the  button on the remote control.

Note : TV won't be completely switching off in this mode. NOT RECOMMENDED FOR PROLONGED NON-USE.

### Powering off

To power the TV off, press and hold the  button on the remote control, The TV will shut down directly.

**NOTE:It is recommended to watch the TV in HOME mode,The picture mode is Energy Saving,Select "Home"mode under Select TV mode in the boot guide ,you can also press in Settings -> Display and Sound -> Picture ->Picture Mode -> Energy Saving.**

## **Initial Setup**

The first time you switch on the TV, the Welcome screen appears, which guides you through the initial setup process. Follow the on-screen instructions to finish the initial setup process such as selecting the correct language, connecting to the network, country, scanning channels, and more. Some of the initial setup steps are optional and you can choose to 'Skip' them if you wish. If you skip a step, you can perform the setup later from the settings menu.

When TV comes up a message to setup a password (for parental lock purpose), please note the password **only accept digits**, not letters. Press the number button on remote or number symbol on the screen keyboard to do so.

**Note: Choosing the correct country selection is vital to tuning the TV successfully. Wrong country selection may result the TV missing the channels completely or partially. When scan the channels, please set up scan mode to "Antenna".**

If the channel search retrieved no channel or only some channels it could be caused by poor broadcasting or antenna reception isn't strong enough. Manufacturers cannot be held responsible for poor broadcasting in some areas or antenna reception issue. Please contact your local antenna technician if it is a reception issue.

If TV is turned into standby mode during initial installation setup, it might cause higher standby power consumption.



## **Network Connection**



Your TV will require an internet connection to operate all functions. Data usage charges may apply. Please refer to your Internet Service Provider (ISP) for additional information. To access the internet, you must subscribe to high speed broadband internet service from your internet service provider.

Your TV can be connected to your home network in two ways:

- Wired, using the RJ45 (LAN) connector on the back panel.
- Wireless, using the internal wireless or external wireless USB adapter and your home wireless network. Please get WIFI password ready if it has one. Please contact ISP or technician who set up the router.



## **Watching Connected Devices**

Press  on the remote control to display the source list. Press  to select TV or other input sources and press OK to confirm.

You can also press  home page button on the remote control to display the homepage, press arrow key to move to the Dashboard on the top right hand side, then press arrow key to move to the  to select the input source.

## **Accessing Channels**



Using the numeric buttons: press the corresponding numeric buttons on the remote control to access the channels.

Using the P  /  buttons on the remote control to change channels.

Press OK button in TV mode to bring up channel LIST, use  and OK to select channels.

## Adjusting Volume

Volume control: press  +/- buttons on the remote control to increase or decrease the volume.



Sound mute: press the  button to temporarily mute the sound. Press this button again or the + button to restore the sound.

## Basic TV instructions

### Installing Channels

This section describes how to search and store channels automatically. This may be done in any of the cases below:

- you have skipped the channel installation step in the initial setup;
- you are prompted that there are no channels in TV mode;
- you want to update channels list.

1. Press the  **Inputs button** to enter the Inputs menu is set to **Live TV**.
2. In TV mode, press  **Dashboard button** on the remote control and select **All Settings >Channels and Inputs**.
3. Go into **Channels** and select **Channel Scan**, press **OK** button to start.
4. The channel scan may take a few minutes. After the automatic search, channels are arranged in a preset order. You can also **skip, move or swap** channels, press the  button-> Setup -> Channel edit.

### Using EPG (Electronic Program Guide)

EPG is an on-screen guide that displays scheduled digital TV program. You can navigate, select and view programs.

Note: The DTV EPG does not require an internet connection.

-To use the DTV EPG, Press EPG button on the remote control, the Program Guide menu will appear, which allows you to get information about the current or future program playing on each channel. Navigate through the different programs using the arrow button on the remote control.

-It might have no information to be displayed. Please change channel first and TV can get proper EPG information from TV signal when the channel is on.

### Using Subtitles

You can enable subtitles for each TV channel. Subtitles are broadcast via DVB-T digital broadcasts. With digital broadcast, you have the additional option of selecting a preferred subtitle language.

#### Access subtitle menu

In TV mode, press  **Menu button** then select **Setup**, press the > button select Subtitle and press OK to enter. You can set up subtitle language, 2nd Digital subtitle language and subtitle type via the menu.

# Accessing Smart TV Homepage

-Press **home** button on the remote control to display the homepage.

-To **quit** homepage, press **input source** button to access TV and other input mode.

The homepage allows you to enjoy Internet Applications (Apps) and specially adapted Internet websites, and perform system settings for your TV. You can make controlling with the TV remote control.

-Press **^/√/</>** and OK to enter the desired Apps, functions or settings.

-To change the Favorites apps order, select an app, press OK button and hold, a menu will appear and you can press **^/√** to change.

-Press **←** return button to return to the homepage.

**Live**  
The content of h YHl WUbbY recommended by Google

**Apps**  
Access the App Centre to display all installed apps.

**Library**  
View records, manage watch list.

**Text search**  
Enter text manually to search TV apps.

**Dashboard**  
Dashboard contains user account, settings page, input source list, etc.

**For you**  
Displays Application fYWa a YbXUjcbz YdlgcXYg cZH YXU] m Wi fhcca gdlb!cZ fYg a YZhd d]Wg Zf nei zhour apps.

**Notification**  
Advertising, New Arrivals, K Ufb]b[ g UbX Legal Statements, and System Messages.

**Your apps**  
Customizable for quick access.

The screenshot shows the Smart TV homepage interface. At the top, there are navigation tabs: 'For you', 'Live', 'Apps', and 'Library'. Below these is a large featured area for 'max Chimp Crazy' with a gorilla image and 'All episodes available'. Underneath are 'Top picks for you' with several app thumbnails. At the bottom, there is a row of 'Your apps' including LiveTV, Netflix, prime video, Disney, hulu, vudu, YouTube, Free TV, and TV. Blue lines connect the text callouts to their respective elements on the screen.

## Note

The layout and functionality of the homepage will change dynamically with the version of the launcher. All images in the user manual are for reference only.

-Apps can be downloaded via google play store, google service account is required. Please sign in or create a new account before starting the service.

## Delete an app or game

From the TV Home screen, press **Dashboard** button and select " All Setting".

-Under "Settings", Select Apps.

-Under "Apps" select "see all apps" and choose the app you want to remove.

-Select Uninstall.

According to circumstances of the content provider, an application's updates or the application itself may be discontinued.

Changes in application content may be made without prior notice by service provider.

## Notes:

- Configure the network settings before using Smart TV applications.
- Slow responses and/or interruptions may occur, depending on your network conditions.
- If you experience a problem using an application, please contact the content provider.

Since the connection with Internet takes time, it's recommended that you wait a few minutes to use the Smart TV feature after activation of TV from standby.

## Help function

The Help function offers a lot of information about your TV operation.

To use the Help function, Press **⬆** home button and then use the arrow and OK buttons to select and enter "Apps" to select **Help app**.

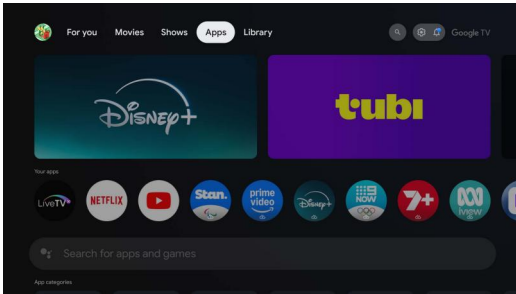

This Help function explains how to use this TV. Additionally, you can also refer to the Setup Guide for descriptions about TV installation, and the Reference Guide for parts descriptions and specifications of this TV.

## USB FUNCTION (Media Player)

Press **⬆** home button and then use the arrow and OK buttons to select and enter "Apps" to select **Media**.

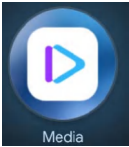

You can enjoy photos/music/movies stored on a USB device on the TV screen.

Select Device on the media player main menu.

Select folder from the menu that is displayed, browse the files and select the desired files to playback.

When play the file, press OK button to check the file information and other functions.

You can press **☰** menu button to set up play mode and other settings.

The formats supported

Audio Format:

.MPEG1/2 Layer 1, .MPEG1/2 Layer 2, .MPEG1/2/2.5 Layer 3, .AC3(DD),  
.EAC3(DDP), .AAC-LC, .FLAC.

Video Format:

.VP9, .HEVC/H.265, .MPEG1/2, .MPEG4, .Sorenson H.263, .H.263, .H.264,  
.VC1, .VP8, .AV1.

image Format:

.jpg/ .jpeg, .bmp, .png, .Gif.



## **eARC (Enhanced Audio Return Channel)**

If you want to use eARC function, Please set EDID version to EDID version 2.1 (Settings-> Channels and Inputs-> Inputs->select HDMI port -> HDMI EDID Version ) In addition, the eARC switch needs to be turned on (Settings->Display and Sound->Sound->eARC).

## **Google Assistant**

-The remote needs to be paired already to be able to use this function. To pair the remote, press “Volume – key” and “arrow pointing to the left” simultaneously, while keeping the remote close to the TV and pointing to the stand-by light.

-Quickly find and play your favorite shows, get answers and control your home. Your Assistant is now ready to help on eligible Android TV devices.

-Press  google assistant button on your remote to get started.

-An introduction will appear on your TV screen, follow the steps to get started.

-When Give a command or ask a question, please close the top remote to your mouth to get better reception.

### **Note:**

The remote has Bluetooth function, please pair remote to TV if you skip it on Initial Setup. Google sign in is required for the service.

## **Chromecast Built-in**

Chromecast built-in delivers multi-screen TV and audio experiences with speakers. Casting is as simple as pressing a button from your favorite app. Watch your favorites on the TV while switching to another app.

Listen to your top tunes while taking a phone call or sending a text, all without interrupting what’s playing on the speakers.

With Chromecast built-in, your phone is your personalized remote control that you can use to browse, play, pause, and even make playlists.

### **How to cast**

To set up your Chromecast built-in, visit [chromecast.com/built-in/setup](https://chromecast.com/built-in/setup)

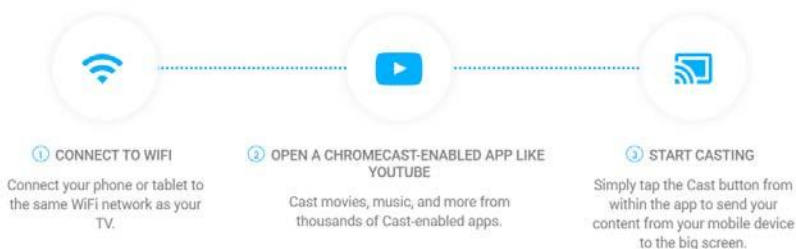



Press the  Dashboard button, enter the Sound menu, and select dbx-tv Total Sonics.

Your TV will configure many of the audio settings to suit that mode. You can then change other settings (like Bass/Treble, and dbx-tv Audio Enhancements), to suit your listening preferences. You're probably already familiar with Bass and Treble, but this TV includes dbx-tv's Total Technology, which adds some very useful additional features, as follows:

- **Total Technology:** Delivers the best possible audio experience from your TV.
- **Total Sonics:** Optimizes overall sound quality by increasing bass, making dialog clear and natural, and widening the sound field.
- **Total Volume:** Maintains consistent loudness levels despite loud commercials and channel or input changes.
- **Total Surround:** Creates an immersive surround sound experience making sounds appear beside, behind and above you. Use with Total Sonics.

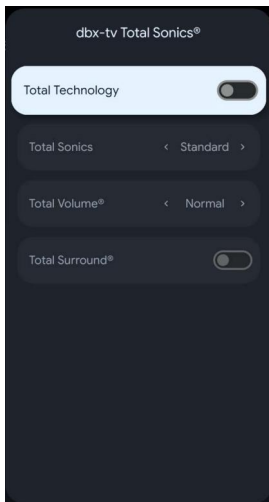

Manufactured under license from THAT Corporation. THAT Corporation and dbx-tv are registered trademarks of THAT Corporation. Total Technology, Total Sonics, Total Surround and Total Volume are trademarks of THAT Corporation.

## **Trouble-shooting**

You can solve most common problems yourself using the solutions below. If the problem persists after checking the suggested solutions, please contact CHIQ customer care **1300796688**.

### **General problems**

#### **The TV set will not switch on or stop responding.**

- Plug the power cable of the TV set into a working mains socket.
- Replace the batteries in the remote control.
- Unplug the plug of the power cable from the mains socket, wait approx. 30 seconds and plug the power cable back in. The device should then work normally.

#### **The remote control does not work**

- Is there an obstruction between the remote control and the sensor on the TV?
- Replace the batteries.
- Make sure that the remote control sensor is not exposed to direct sunlight.

If the above doesn't resolve the problem, you may have to do a 'Power Reset' procedure on your TV. You need to switch off the TV at the wall socket and take the batteries out of remote control. Wait for 30 minutes , then put the batteries back into the remote and try again.

#### **How to reset the TV.**

- CHIq TV runs the Android™ OS, which is also used in many smartphones and tablets. As with these devices, resetting your Google TV is an effective method to resolve some issues such as "the TV is too sluggish and slow", "the remote control does not work", or "the App is extremely slow." etc.
- IMPORTANT: Be aware that if you perform a factory reset, all of the TV's data and settings (Wi-Fi and wired network setting information, Google account and other login information, Google Play and other installed applications, etc.) will be erased, and the TV will return to how it was at the time of purchase.
- Press the menu button, settings, device preferences, reset.

## **TV reception problems**



### **No picture / No Signal!**

- Did you select 'Australia' as the country while setting up? If not, you may have to do a factory reset on the TV by making sure correct country selection is made this time.
- Is the antenna plugged in properly? Is the antenna cable damaged?
- Is the antenna cable plug firmly connected?
- Have you selected the correct signal source on the TV set?
- Have you already executed a channel search at your present location?
- Are all the connection cables to external signal sources properly connected?
- Is the connection cable to the external signal source damaged?
- Have you selected the correct signal source on the TV set?

### **One or group Channels disappears by itself.**

- Please rescan the channel again.
- In Tv mode, press menu button, settings, channel, then turn off the "auto channel update".

### **No sound**

- Is the sound muted? Press the  button .
- Is the volume turned down? Press the + button .

### **No colour**

- Adjust the colour settings
- Reset the picture settings  
Press  button, go to picture , select reset to default
- Check the programme is broadcast in colour.
- Check that the channel is tuned properly.

## **Multimedia playback problems**

### **File is not played back**

- Check that the USB mass storage device contains compatible files.

### **Problems with playback from external devices**

#### **No sound**

- Check that the audio cable is properly connected or damaged.
- Make sure that you have selected the correct signal source on your TV set.

#### **Sound is distorted or humming**

- Clean the connector plugs.
- Replace the connection cable to the external device.

## Problems with online services (Smart TV)

### If you are using a cable network connection (LAN)

- Check that the network cable is properly connected.
- Check whether the network cable is damaged.
- Check whether you can access the internet from another device on the network.
- It is possible that the server for the selected service is temporarily down.
- Check the network settings on the TV set.

### If you are using a wireless network

- Check whether you can access the internet from another device on the wireless network.
- It is possible that the server for the selected service is temporarily down.
- Check the network settings on the TV set.

## Wall-mounting

Please ensure your kit is compatible with one of the following VESA Standards: 400 x 200 mm. The kit is not included in the package. To do this, dismount the stand as follows:

1. Power the device off and unplug all cables and connectors. For the following steps you will need a conventional Phillips screwdriver.
2. Lie a soft cloth on an empty, level table and carefully place the TV screen side down on it.
3. Undo the fastening screws on the stand. See also the Installation Guide of Base Stand (supplied). The stand is now removable.
4. Install the VESA wall mount on the back of the monitor. Follow the installation instructions that came with your wall mount kit.



**Warning:** Make sure that the rawlplugs and screws you use to fit the device to the wall are strong enough to support the weight of the device. Also make sure that the material of the wall itself is strong enough.



**Warning:** It is recommended not to use the product in places where there is oil smoke or steam that may damage the material of this product.



Keep the base, the stand and the screws in a safe place in case you need to reassemble the base again. If necessary, you can also disassemble the base so it takes up less space.

## Restraining Device (Optional)

### Step 1

Align the bolts with the the screw hole on the upper backof the TV and screw it in in partially.(as picture 1)

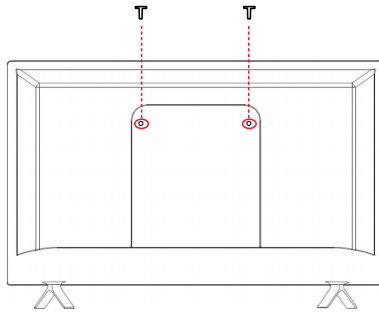

### Step 2

Screw the bolts on to the wall and leave some space for hanging the steel wire. (as picture 2)

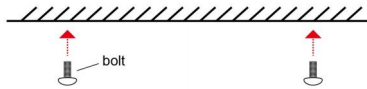

### Step 3

Wrap the steel wire around the bolts of the wall and TV back to fix the TV. (as picture 3)

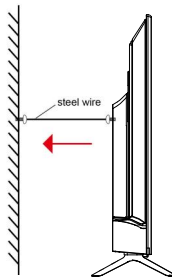

### Note:

**All the pictures in this user manual are for illustrative purposes only and may be used for reference. Depending on the model, the actual product shall prevail.**

