



Register your
new device on
MyBosch now and
get free benefits:
[bosch-home.com/
welcome](https://bosch-home.com/welcome)



Fridge-freezer

KFD96..

[en] Information for Use



**You can find additional information and explanations online.
Scan the QR code on the title page.**



Table of contents

1 Safety	3	6.5 Fruit and vegetable container with humidity control	16
1.1 General information	3	6.6 Butter and cheese compart- ment	16
1.2 Intended use	4	6.7 Door tray	16
1.3 Restriction on user group	4	6.8 Ice storage container	16
1.4 Safe transport	4	6.9 Accessories	17
1.5 Safe installation	4	7 Basic operation	17
1.6 Safe use	5	7.1 Switching on the appliance	17
1.7 Damaged appliance	7	7.2 Operating tips	18
2 Preventing material damage	8	7.3 Switching off the appliance	18
3 Environmental protection and saving energy	9	7.4 Setting the temperature unit ...	18
3.1 Disposing of packaging	9	7.5 Setting the temperature	18
3.2 Saving energy	9	7.6 Keylock	18
4 Installation and connection	10	8 Additional functions	19
4.1 Scope of delivery	10	8.1 Super cooling	19
4.2 Criteria for the installation loca- tion	10	8.2 Automatic Super freezing	19
4.3 Installing the appliance	10	8.3 Manual Super freezing	20
4.4 Preparing the appliance for the first time	10	8.4 Rest mode	20
4.5 Connecting the appliance to the drinking water connec- tion	11	8.5 Filter change notification	20
4.6 Connecting the appliance to the electricity supply	11	9 Alarm	21
5 Familiarising yourself with your appliance	12	9.1 Door alarm	21
5.1 Appliance	12	9.2 Temperature alarm	21
5.2 Control panel	13	10 Home Connect	21
5.3 Control panel (submenu)	14	10.1 Setting up the Home Connect app	22
5.4 Control elements (ice and wa- ter dispenser)	15	10.2 Setting up Home Connect	22
6 Features	15	10.3 Switching on the connection to the WLAN home network (Wi-Fi)	22
6.1 Shelf	15	10.4 Switching off the connection to the WLAN home network (Wi-Fi)	22
6.2 Bottle shelf	15	10.5 Installing updates for the Home Connect software	22
6.3 Freezer tray	15	10.6 Resetting Home Connect set- tings	22
6.4 Storage container	16		

10.7 Remote diagnostics	23	15 Cleaning and servicing	29
10.8 Data protection	23	15.1 Preparing the appliance for cleaning	29
11 Refrigerator compartment	23	15.2 Cleaning the appliance	29
11.1 Tips for storing food in the re- frigerator compartment	23	15.3 Removing the fittings	30
11.2 Chill zones in the refrigerator compartment	24	15.4 Removing appliance com- ponents	31
12 Freezer compartment	24	16 Troubleshooting	32
12.1 Freezing capacity	24	16.1 Power failure	37
12.2 Fully utilising the freezer compartment volume	24	16.2 Conducting an appliance self-test	37
12.3 Tips for storing food in the freezer compartment	24	17 Storage and disposal	38
12.4 Tips for freezing fresh food ...	24	17.1 Taking the appliance out of operation	38
12.5 Shelf life of frozen food at -18 °C (0 °F)	25	17.2 Disposing of old appliance ...	38
12.6 Defrosting methods for frozen food	25	18 Customer Service	39
13 Water system	25	18.1 Product number (E-Nr.), pro- duction number (FD) and consecutive numbering (Z- Nr.)	39
13.1 Water filter	25	19 Technical data	39
13.2 Ice and water dispenser	27	19.1 Information regarding Free and Open Source Software ..	40
14 Defrosting	29	20 Declaration of Conformity	40
14.1 Defrosting in the refrigerator compartment	29	20.1 Statement of Compliance for Great Britain	41
14.2 Defrosting in the freezer com- partment	29		

1 Safety

Observe the following safety instructions.

1.1 General information

- Read this instruction manual carefully.
- Keep the instruction manual and the product information safe for future reference or for the next owner.
- Do not connect the appliance if it has been damaged in transit.

1.2 Intended use

Only use this appliance:

- for chilling and freezing food, for dispensing ice and water.
- in private households and in enclosed spaces in a domestic environment.
- Up to an altitude of 2000 m above sea level.

1.3 Restriction on user group

This appliance may be used by children aged 8 or over and by people who have reduced physical, sensory or mental abilities or inadequate experience and/or knowledge, provided that they are supervised or have been instructed on how to use the appliance safely and have understood the resulting dangers.

Do not let children play with the appliance.

Cleaning and user maintenance must not be performed by children unless they are being supervised.

Children above the age of three years old and younger than eight years old may load and unload the the fridge-freezer.

1.4 Safe transport

WARNING – Risk of injury!

The heavy weight of the appliance may result in injury when lifted.

- ▶ Do not lift the appliance on your own.

1.5 Safe installation

WARNING – Risk of electric shock!

Incorrect installation is dangerous.

- ▶ Connect and operate the appliance only in accordance with the specifications on the rating plate.
- ▶ Connect the appliance to a power supply with alternating current only via a properly installed socket with earthing.
- ▶ The protective conductor system of the domestic electrical installation must be properly installed.
- ▶ Never equip the appliance with an external switching device, e.g. a timer or remote control.
- ▶ When the appliance is installed, the mains plug of the power cord must be freely accessible. If free access is not possible, an

isolating switch must be integrated into the permanent electrical installation according to the installation regulations.

- ▶ When installing the appliance, check that the power cable is not trapped or damaged.

If the insulation of the power cord is damaged, this is dangerous.

- ▶ Never let the power cord come into contact with heat sources.

⚠ WARNING – Risk of explosion!

If the appliance's ventilation openings are closed off, a leak in the refrigeration circuit may result in a flammable mixture of gas and air.

- ▶ Keep ventilation openings in the appliance casing or in the integrated casing clear of obstruction.

⚠ WARNING – Risk of fire!

It is dangerous to use an extended power cord and non-approved adapters.

- ▶ Do not use extension cables or multiple socket strips.
- ▶ Only use adapters and power cords approved by the manufacturer.
- ▶ If the power cord is too short and a longer one is not available, please contact an electrician to have the domestic installation adapted.

Portable multiple socket strips or portable power supply units may overheat and cause a fire.

- ▶ Do not place portable multiple socket strips or power supply units on the back of the appliance.

1.6 Safe use

⚠ WARNING – Risk of electric shock!

An ingress of moisture can cause an electric shock.

- ▶ Only use the appliance in enclosed spaces.
- ▶ Never expose the appliance to intense heat or humidity.
- ▶ Do not use steam- or high-pressure cleaners to clean the appliance.

⚠ WARNING – Risk of suffocation!

Children may put packaging material over their heads or wrap themselves up in it and suffocate.

- ▶ Keep packaging material away from children.

▶ Do not let children play with packaging material. Children may breathe in or swallow small parts, causing them to suffocate.

- ▶ Keep small parts away from children.
- ▶ Do not let children play with small parts.

⚠ WARNING – Risk of explosion!

If the cooling circuit is damaged, flammable refrigerant may escape and explode.

- ▶ To accelerate the defrosting process, do not use any other mechanical devices or means other than those recommended by the manufacturer.
- ▶ If food is stuck to the freezer compartment, loosen it with a blunt object such as the handle of a wooden spoon.

Products which contain flammable propellants and explosive substances may explode, e.g. spray cans.

- ▶ Do not store products which contain flammable propellants (e.g. spray cans) or explosive substances in the appliance.

⚠ WARNING – Risk of fire!

Electrical devices within the appliance may cause a fire, e.g. heaters or electric ice makers.

- ▶ Do not operate electrical devices within the appliance.

⚠ WARNING – Risk of injury!

Containers that contain carbonated drinks may burst.

- ▶ Do not store containers that contain carbonated drinks in the freezer compartment.

Injury to the eyes caused by escaping flammable refrigerant and hazardous gases.

- ▶ Do not damage the tubes of the refrigerant circuit or the insulation.

The appliance may tip.

- ▶ Do not stand or support yourself on the base, runners or doors.

⚠ WARNING – Risk of cold burns!

Contact with frozen food and cold surfaces may cause burns by refrigeration.

- ▶ Never put frozen food straight from the freezer compartment into your mouth.

- ▶ Avoid prolonged contact of the skin with frozen food, ice and surfaces in the freezer compartment.

⚠ CAUTION – Risk of harm to health!

To prevent food from being contaminated, you must observe the following instructions.

- ▶ If the door is open for an extended period of time, this may lead to a considerable temperature increase in the compartments of the appliance.
- ▶ Regularly clean the surfaces that may come into contact with food and accessible drain systems.
- ▶ Flush the water system if water has not been drawn for five days.
- ▶ Store raw meat and fish in suitable containers in the refrigerator so that they do not touch or drip on other food.
- ▶ If the fridge/freezer is empty for an extended period of time, switch off the appliance, defrost it, clean it and leave the door open to prevent the formation of mould.

Metal or metal-style parts in the appliance may contain aluminium. If acidic food comes into contact with aluminium in the appliance, aluminium foil ions may pass into the food.

- ▶ Do not consume soiled food.

1.7 Damaged appliance

⚠ WARNING – Risk of electric shock!

If the appliance or the power cord is damaged, this is dangerous.

- ▶ Never operate a damaged appliance.
- ▶ Never pull on the power cord to unplug the appliance. Always unplug the appliance at the mains.
- ▶ If the appliance or the power cord is damaged, immediately unplug the power cord or switch off the fuse in the fuse box and turn off the water tap.
- ▶ Call customer service. → *Page 39*

Improper repairs are dangerous.

- ▶ Repairs to the appliance should only be carried out by trained specialist staff.
- ▶ Only use genuine spare parts when repairing the appliance.
- ▶ If the power cord or the appliance power cable of this appliance is damaged, it must be replaced with a special power cord or

special appliance power cable, which is available from the manufacturer or its Customer Service.

⚠ WARNING – Risk of fire!



If the tubes are damaged, flammable refrigerant and harmful gases may escape and ignite.

- ▶ Keep naked flames and ignition sources away from the appliance.
- ▶ Ventilate the room.
- ▶ Switch off the appliance. → *Page 18*
- ▶ Unplug the mains plug from the mains or switch off the circuit breaker in the fuse box.
- ▶ Call customer service. → *Page 39*

2 Preventing material damage

ATTENTION

The high weight of the appliance or, if not rolling freely, the appliance's castors may damage the floor when the appliance is moved.

- ▶ Transport the appliance using a sack truck.
- ▶ Use floor protection when moving the appliance, and do not move it in a zigzag fashion.

When the appliance door is closed, an open door pillar may damage the appliance.

- ▶ Never open the door pillar manually.
- ▶ If the door pillar has been opened, close it before closing the appliance door.

Using the appliance, base, runners or doors as a seat or climbing surface may damage the appliance.

- ▶ Do not stand or lean on the appliance, base, runners or doors.

If the water pressure is too high or too low, the appliance may not be able to operate properly.

- ▶ Make sure that the water pressure in the water supply system is at least 200 kPa (2 bar) and max. 800 kPa (8 bar).
- ▶ If the water pressure exceeds the maximum value specified, a pressure-reducing valve must be installed between the drinking water connection and the hose set of the appliance.

Modified or damaged water hoses may result in material damage and damage to the appliance.

- ▶ Never kink, crush, modify or cut through water hoses.
- ▶ Only use the water hoses supplied with the appliance or genuine spare hoses.
- ▶ Never re-use water hoses that have been used before.
- ▶ Never pull on the water hose on the rear panel of the appliance.

Contamination with oil or fat may cause plastic parts and door seals to become porous.

- ▶ Keep plastic parts and door seals free of oil and grease.

Metal or metal-style parts in the appliance may contain aluminium. When aluminium comes into contact with acidic foods, it corrodes and discolours.

- ▶ Only store packaged food in the appliance.

If you clean fittings and accessories in the dishwasher, this may cause them to become deformed or discoloured.

- ▶ Never clean fittings and accessory in the dishwasher.

3 Environmental protection and saving energy

3.1 Disposing of packaging

The packaging materials are environmentally compatible and can be recycled.

- ▶ Sort the individual components by type and dispose of them separately.

3.2 Saving energy

If you follow these instructions, your appliance will use less power.

Selecting the installation location

- Keep the appliance out of direct sunlight.
- Install the appliance as far away as possible from heating elements, cookers and other heat sources:
 - Maintain a 30 mm clearance to electric or gas cookers.
 - Maintain a 300 mm clearance to oil or solid-fuel cookers.

- Never cover or block the external ventilation openings.

Saving energy during use

Note: The arrangement of the fittings does not affect the energy consumption of the appliance.

- Open the appliance only briefly and then close it carefully.
- Never cover or block the interior ventilation openings or the exterior ventilation openings.
- Transport purchased food in a cool bag and place in the appliance quickly.
- Allow warm food and drinks to cool down before storing them.
- Thaw frozen food in the refrigerator compartment to utilise the low temperature of the food.
- Always leave some space between the food and to the back panel.
- Vacuum the external ventilation grilles when they are dusty.

Control panel energy-saving mode

If the appliance is not being used, the control panel automatically switches to control panel energy-saving mode.

In control panel energy-saving mode, the selection option for the ice and water dispenser is shown with reduced brightness.

Notes

- If Super cooling is switched on, "super" (Refrigerator compartment) lights up.
- If Super freezing is switched on, "super" (Freezer compartment) lights up.

Control panel energy-saving mode is deactivated as soon as you operate the control panel, press the dispensing button or open the door.

4 Installation and connection

4.1 Scope of delivery

After unpacking all parts, check for any transport damage and for completeness of delivery.

If you have any complaints, contact your dealer or our after-sales service → *Page 39*.

The delivery consists of the following:

- Free-standing appliance
- Equipment and accessories¹
- Installation material
- Installation instructions
- User manual
- Customer service directory
- Warranty enclosure²
- Energy label
- Information on energy consumption and noises
- Information about Home Connect

4.2 Criteria for the installation location

WARNING **Risk of explosion!**

If the appliance is in a space that is too small, a leak in the refrigeration circuit may result in a flammable mixture of gas and air.

- ▶ Only install the appliance in a space with a volume of at least 1 m³ per 8 g refrigerant. The volume of refrigerant is indicated on the rating plate.

→ "Appliance", Fig. **1/9**
Page 13

The weight of the appliance ex works may be up to 155 kg depending on the model.

The subfloor must be sufficiently stable to bear the weight of the appliance.

The surface must be level.

This refrigerator is intended for use at ambient temperatures of 10 °C to 43 °C.

The appliance is fully functional within the permitted room temperature.

If the appliance is operated at colder room temperatures, the appliance will not be damaged up to a room temperature of 5 °C.

Over-and-under and side-by-side installation

If you want to install 2 refrigerating appliances one over the other or side by side, you must maintain a clearance of at least 150 mm between the appliances. Selected appliances can be installed without a minimum clearance. Ask your dealer or kitchen planner about this.

4.3 Installing the appliance

- ▶ Install the appliance in accordance with the enclosed installation instructions.

4.4 Preparing the appliance for the first time

1. Remove the informative material.
2. Remove the protective foil and transit bolts, e.g. remove the adhesive strips and carton.
3. Clean the appliance for the first time. → *Page 29*

¹ Depending on the appliance specifications

² Not in all countries

4.5 Connecting the appliance to the drinking water connection

Requirements

- A corner valve must be installed on the water connection and be freely accessible following installation of the appliance.
 - The water connection is checked and is of drinking water quality.
1. Draw mains water from the domestic drinking water connection until the water is no longer cloudy and contains no deposits. If the drinking water is still cloudy or contains deposits, install an external water filter system.
 2. Install the water hose according to the enclosed installation instructions on the appliance.

4.6 Connecting the appliance to the electricity supply

1. Insert the appliance plug of the power cord into the appliance.
2. Insert the mains plug of the appliance's power cable in a socket nearby.
The connection data of the appliance can be found on the rating plate.
→ "Appliance", Fig. **1**/**9**
Page 13
3. Check the mains plug is inserted properly.
 - ✓ The control panel shows an animation and is locked.
 - ✓ The appliance is ready to use once the animation has ended and the temperature displays light up.

5 Familiarising yourself with your appliance

5.1 Appliance

You can find an overview of the parts of your appliance here.

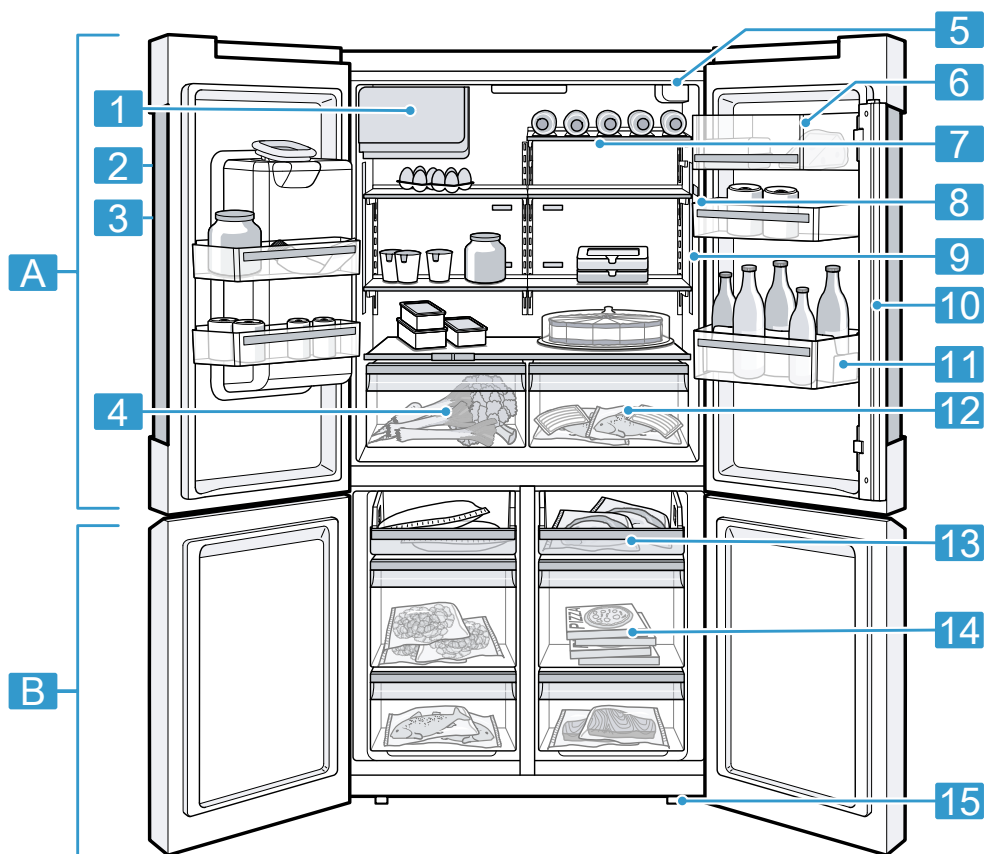

1

Deviations between your appliance and the diagrams may differ with regard to their features and size.

A Refrigerator compartment
→ Page 23

B Freezer compartment
→ Page 24

1 Ice cube container

2 Control panel → Page 13

3	Ice and water dispenser → <i>Page 27</i>
4	Fruit and vegetable container with humidity control → <i>Page 16</i>
5	Water filter → <i>Page 25</i>
6	Butter and cheese compartment → <i>Page 16</i>
7	Bottle shelf → <i>Page 15</i>
8	Lighting

9	Rating plate → <i>Page 39</i>
10	Door pillar with condensation protection → <i>Page 8</i>
11	Door tray for large bottles → <i>Page 16</i>
12	Storage container → <i>Page 16</i>
13	Freezer tray → <i>Page 15</i>
14	Frozen food container → <i>Page 31</i>
15	Screw foot





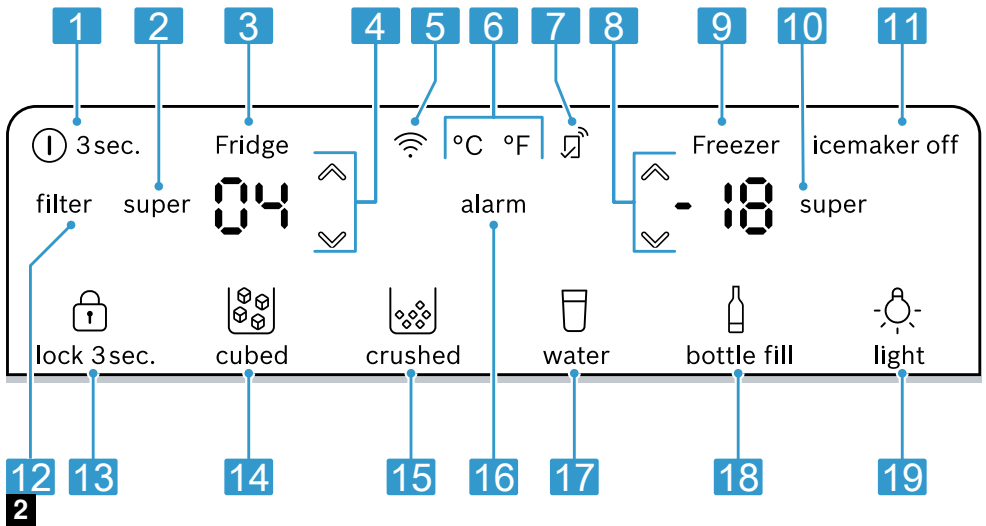







5.2 Control panel

You can use the control panel to configure all functions of your appliance and to obtain information about the operating status.



- 1** ① 3 sec. switches the appliance on or off.
- 2** super (Refrigerator compartment) switches Super cooling on or off.
- 3** Displays the set temperature for the refrigerator compartment in °F or °C.

- 4** ∇/∧ (Refrigerator compartment) sets the temperature of the refrigerator compartment.
- 5** 📶 switches the connection to the WLAN home network (Wi-Fi) on or off.
- 6** °C/°F converts the temperature unit.

-
- 7**  lights up if user-defined settings have been set via the Home Connect app. You can find more information in the Home Connect app.
-
- 8**  (Freezer compartment) sets the temperature of the freezer compartment.
-
- 9** Displays the set temperature for the freezer compartment in °F or °C.
-
- 10**  super (Freezer compartment) switches Super freezing on or off.
-
- 11**  icemaker off switches ice cube production off or on.
-
- 12**  filter lights up when the filter needs to be replaced.
-
- 13**  lock 3 sec. switches the button lock for the control panel on or off.
-
- 14**  cubed sets dispensing to ice cubes.
-
- 15**  crushed sets dispensing to crushed ice.
-
- 16**  alarm switches the warning signal off.
-
- 17**  water starts water dispensing.
-
- 18**  bottle fill sets dispensing to a specific amount of water.
-
- 19**  light switches the permanent light for the ice and water dispenser on or off.
-

5.3 Control panel (submenu)

You can configure further settings in the submenu.

5.4 Control elements (ice and water dispenser)

You can find an overview of the parts of your ice and water dispenser here.

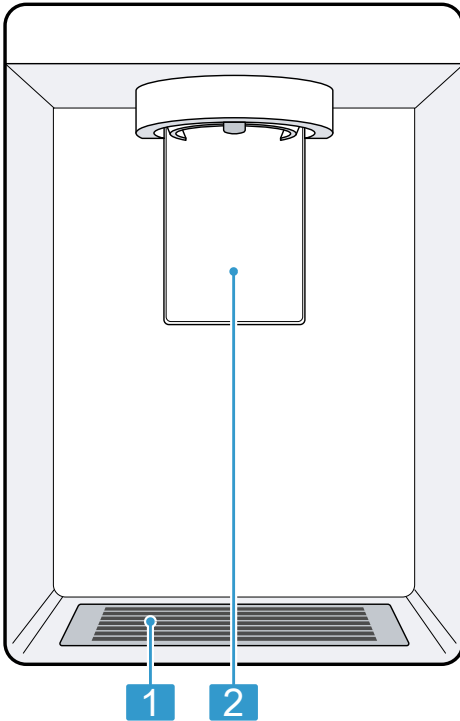

3

1 Drip grate

2 Dispensing button

6 Features

The features of your appliance depend on the model.

6.1 Shelf

ATTENTION

If fitted at an angle, the hooks on the shelf can scratch the rear panel of the refrigerator compartment.

- ▶ Ensure that the shelf is horizontal and that the hooks are properly fitted in place.

To vary the shelf as required, you can remove the shelf and re-insert it elsewhere.

→ "Removing the shelf", Page 30

Note: To avoid impeding the circulation of air, do not cover the inner ventilation openings.

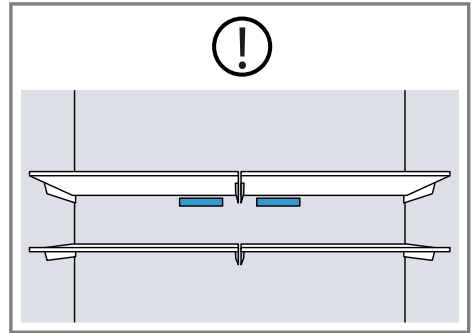

6.2 Bottle shelf

Store bottles securely on the bottle shelf.

To vary the bottle shelf as required, you can remove the bottle shelf and re-insert it elsewhere.

→ "Removing the shelf", Page 30

6.3 Freezer tray

You can freeze smaller quantities of food quickly on the freezer tray, e.g. berries, pieces of fruit, herbs and vegetables.

Distribute the frozen items evenly on the freezer tray and leave to freeze for approx. 10 to 12 hours. Then place in a freezer bag or a freezer box.

6.4 Storage container

The temperatures in the storage container are lower than in the refrigerator compartment. Temperatures below 0 °C (32 °F) may occur occasionally.

In order to reach temperatures close to 0 °C (32 °F) in the storage container, set the refrigerator compartment temperature to 2 °C (34 °F).

→ *Page 18*

Use the lower temperatures in the storage container to store highly perishable food, e.g. fish, meat and sausages.

6.5 Fruit and vegetable container with humidity control

Store fresh fruit and vegetables loose in the fruit and vegetable container. Cover any chopped fruit and vegetables, or store in air-tight packaging. You can adjust the humidity in the fruit and vegetable container using the humidity controller and a special seal. This allows fresh fruit and vegetables to be stored for up to twice as long as with conventional storage.

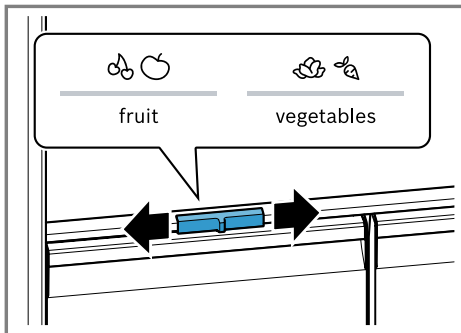

The air humidity in the fruit and vegetable container can be set according to the type and amount of food to be

stored by moving the humidity controller:

- Move to the left for low humidity ☁☁ when primarily storing fruit or mixed items, or if the appliance is very full.
- Move to the right for high humidity ☁☁☁ when primarily storing vegetables or when the appliance is not very full.

Condensation may form in the fruit and vegetable container depending on the food and quantity stored. Remove the condensation with a dry cloth and adjust the air humidity to a lower setting using the humidity controller.

To ensure that the quality and aroma are retained, store fruit and vegetables that are sensitive to cold outside of the appliance at temperatures of approx. 8 °C (46 °F) to 12 °C (54 °F), e.g. pineapple, bananas, citrus fruits, cucumbers, courgettes, peppers, tomatoes and potatoes.

6.6 Butter and cheese compartment

Store butter and hard cheese in the butter and cheese compartment.

6.7 Door tray

To adjust the door tray as required, you can remove the door tray and re-insert elsewhere.

→ *"Removing door tray", Page 30*

6.8 Ice storage container

If the ice and water dispenser is switched on, the ice cubes that are produced are automatically stored in the ice storage container.

⚠ WARNING**Risk of injury!**

Reaching into the dispenser opening of the ice storage container can cause cuts.

- ▶ Never reach into the dispenser opening of the ice storage container.

⚠ WARNING**Risk of cold burns!**

Contact with ice cubes and cold surfaces may cause burns by refrigeration.

- ▶ Avoid prolonged contact between the skin and ice cubes or metal surfaces in the ice storage container.

ATTENTION

The ice and water dispenser may become blocked or damaged by food or objects stored in the ice storage container.

- ▶ Never store food or objects in the ice storage container.
- ▶ Never use the ice storage container to store ice cubes that were not made using the ice cube maker.

Tips

- Remove larger quantities of ice cubes directly from the ice storage container or store these in the freezer tray. → *Page 31*
- Use both hands to pull out the ice storage container as this is heavy when full.

6.9 Accessories

Use original accessories. These have been made especially for your appliance.

The accessories for your appliance depend on the model.

Egg tray

Store eggs safely on the egg tray.

Bottle holder

The bottle holder prevents bottles from falling over when the appliance door is opened and closed.

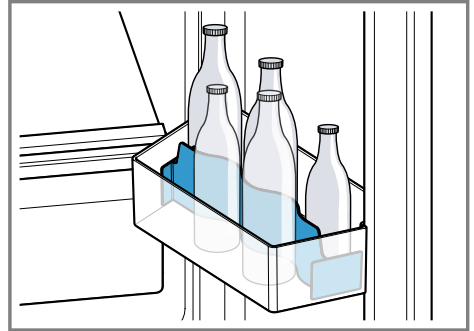
**7 Basic operation****7.1 Switching on the appliance**

1. Electrically connect the appliance.
→ *Page 11*

Note: If the appliance has been previously switched off using the control panel, press and hold **ⓐ 3 sec.** for three seconds.

- ✓ The control panel shows an animation and is locked.
- ✓ The appliance is ready to use once the animation has ended and the temperature displays light up.
- ✓ The motor starts after a delay of up to 5 minutes.
- ✓ The appliance begins to cool.
- ✓ A warning signal sounds and the temperature display (freezer compartment) and "alarm" flash because the freezer compartment is still too warm.

en Basic operation

2. Switch off the warning tone using **alarm**.
- ✓ "alarm" goes out as soon as the set temperature has been reached.
3. Set the required temperature.
→ *Page 18*

7.2 Operating tips

- Once you have switched on the appliance, the set temperature is only reached after several hours. Do not put any food in the appliance until the set temperature has been reached.
- The front and side panels of the housing heat up occasionally. This prevents condensation from forming.
- When closing the door, make sure that the door is not blocked by stored items.
- When you close the door, a vacuum may be created. The door is then difficult to open again. Wait a moment until the vacuum is offset.
- The temperature in the appliance varies due to the following conditions:
 - How often the appliance is opened
 - Load capacity
 - Temperature of newly stored food
 - Ambient temperature
 - Direct sunlight

7.3 Switching off the appliance

1. To activate setting mode, touch the upper area of the control panel.
2. Press and hold  **3 sec.** for 3 seconds.

7.4 Setting the temperature unit

You can choose between the temperature unit °C and °F.

1. To activate setting mode, touch the upper area of the control panel.
2. Press °C/°F.

7.5 Setting the temperature

Setting the refrigerator compartment temperature

1. To activate setting mode, touch the upper area of the control panel.
2. Press  (Refrigerator compartment) repeatedly until the temperature display (refrigerator compartment) shows the required temperature setting.
The recommended temperature in the refrigerator compartment is 4 °C (39 °F).

Setting the freezer compartment temperature



1. To activate setting mode, touch the upper area of the control panel.
2. Press  (Freezer compartment) repeatedly until the temperature display (freezer compartment) shows the required temperature setting.
The recommended temperature in the freezer compartment is -18 °C (0 °F).

7.6 Keylock



The keylock prevents the appliance from being operated accidentally or incorrectly while running.

Switching on the keylock

1. To activate setting mode, touch the lower area of the control panel.

- Press and hold  **lock 3 sec.** for three seconds.
- ✓  "lock 3 sec." lights up.

Switching off the keylock

- ▶ Press and hold  **lock 3 sec.** for three seconds.
- ✓  "lock 3 sec." goes out.

8 Additional functions

Find out which additional functions can be used for your appliance. Additional functions can be set via the Home Connect app.

8.1 Super cooling

With Super cooling, the refrigerator compartment cools as cold as possible.

Switch on Super cooling before placing large quantities of food in the refrigerator compartment.

Note: When Super cooling is switched on, increased noise may occur.

Switching on Super cooling

- To activate setting mode, touch the upper area of the control panel.
- Press **super** (Refrigerator compartment).
- ✓ "super" (Refrigerator compartment) lights up.

Note: After approx. 6 hours, the appliance switches to normal operation.

Switching off Super cooling

- To activate setting mode, touch the upper area of the control panel.
- Press **super**.
- ✓ The previously set temperature is displayed.

8.2 Automatic Super freezing

With automatic Super freezing, the freezer compartment cools down to a much lower temperature than in normal mode. This freezes food more quickly.

The automatic Super freezing switches on if you place fresh food in the bottom frozen food container, starting from the left-hand side.

The automatic Super freezing is activated at the factory. You can deactivate the automatic Super freezing.

If the automatic Super freezing is switched on, "super" (Freezer compartment) lights up and increased noises may occur.

After operation, the appliance switches from automatic Super freezing to normal operation.

Activating automatic Super freezing

- To activate setting mode, touch the upper area of the control panel.
- Press and hold **super** (Refrigerator compartment) for 5 seconds.
- ✓ If 2 audible signals sound, the automatic Super freezing is activated.

Deactivating automatic Super freezing

- To activate setting mode, touch the upper area of the control panel.
- Press and hold **super** (Refrigerator compartment) for 5 seconds.
- ✓ If 3 audible signals sound, the automatic Super freezing is deactivated.

Cancelling automatic Super freezing

- To activate setting mode, touch the upper area of the control panel.

en Additional functions

2. Press **super** (Freezer compartment).
- ✓ The previously set temperature is displayed.

8.3 Manual Super freezing

With Super freezing, the freezer compartment cools as cold as possible. Switch on Super freezing four to six hours before placing food weighing 2 kg or more into the freezer compartment.

Use Super freezing to accelerate ice cube production.

In order to utilise the freezer capacity, use Super freezing.

→ *"Prerequisites for freezing capacity", Page 24*

Note: When Super freezing is switched on, increased noise may occur.

Switching on manual Super freezing

1. To activate setting mode, touch the upper area of the control panel.
 2. Press **super** (Freezer compartment).
- ✓ "super" (Freezer compartment) lights up.

Note: After approx. 54 hours, the appliance switches to normal operation.

Switching off manual Super freezing

1. To activate setting mode, touch the upper area of the control panel.
 2. Press **super** (Freezer compartment).
- ✓ The previously set temperature is displayed.

8.4 Rest mode

The rest mode switches off all non-essential functions.

During rest mode, the following functions are switched off:

- Super cooling
- Automatic Super freezing and manual Super freezing
- Alarm
- Water dispenser
- Ice cube production and ice cube dispensing
- Interior lighting
- Signal tones
- Messages on the control panel

Note: The control panel lighting is switched off during rest mode. "super" (Freezer compartment) lights up at a reduced brightness level.

Switching on rest mode

1. Press ##CP0203SYA##.
2. Press .
3. Press ##CP0206SYB##/
##CP0206SYA## until "ON" lights up.
4. Press ##CP0203SYB##.

Note: After approx. 74 hours, the appliance switches to normal mode.

Switching off rest mode

1. To activate setting mode, touch the upper area of the control panel.
2. Press and hold **super** (Freezer compartment) for 15 seconds until an audible signal sounds.

8.5 Filter change notification

Every six months, the filter change notification is switched on. "filter" lights up.

Note: Increased water consumption switches the filter change notification on sooner.

Switching off the filter change notification

1. Replace the water filter.
The bypass cap does not need to be replaced.
2. Press **filter**.
 - ✓ "filter" goes out.
 - ✓ The filter change status is reset.

9 Alarm

9.1 Door alarm

If the appliance door is open for a while, the door alarm switches on. A warning tone sounds, "alarm" flashes and the set temperature for the affected compartment flashes.

Switching off the door alarm

- ▶ Close the appliance door or press **alarm**.
- ✓ The warning tone is switched off.

9.2 Temperature alarm

If the freezer compartment becomes too warm, the temperature alarm is switched on. A warning tone sounds, "alarm" flashes and the set temperature for the affected compartment flashes.

CAUTION

Risk of harm to health!

During the thawing process, bacteria may multiply and spoil the frozen food.

- ▶ Do not refreeze food after it has been defrosted or started to defrost.
- ▶ Refreeze food only after cooking.
- ▶ These items should no longer be stored for the maximum storage period.

The temperature alarm can be switched on in the following cases:

- The appliance is switched on.
Do not store any food until the appliance has reached the set temperature.
- Large quantities of fresh food are being placed inside.
Switch on Super freezing before placing large quantities of food in the appliance.
- The freezer compartment door is open for too long.
Check whether the frozen food has defrosted or thawed.

Switching off the temperature alarm

- ▶ Press **alarm**.
- ✓ The warning tone is switched off.
- ✓ The temperature display (freezer compartment) briefly indicates the warmest temperature reached in the freezer compartment. The temperature display (freezer compartment) then indicates the set temperature again.
- ✓ From this time on, the warmest temperature is measured again and saved.
- ✓ "alarm" lights up until the set temperature is reached again.

10 Home Connect

This appliance is network-capable. Connect your appliance to a mobile device to control its functions via the Home Connect app.

The Home Connect services are not available in every country. The availability of the Home Connect function depends on the availability of Home Connect services in your country. You can find information about this at: www.home-connect.com.

To be able to use Home Connect, you must first set up the connection to the WLAN home network (Wi-Fi¹) and to the Home Connect app. After switching on the appliance, wait at least 3 minutes until internal device initialisation is complete. Only then should you set up Home Connect. The Home Connect app guides you through the entire login process. Follow the instructions in the Home Connect app to configure the settings.

Tip: Please also follow the instructions in the Home Connect app.

Notes

- Please note the safety precautions in this instruction manual and make sure that they are also observed when operating the appliance via the Home Connect app. → "Safety", Page 3
- Operating the appliance on the appliance itself always takes priority. During this time it is not possible to operate the appliance using the Home Connect app.

10.1 Setting up the Home Connect app

1. Install the Home Connect app on your mobile device.
2. Start the Home Connect app and set up access for Home Connect. The Home Connect app guides you through the entire login process.

10.2 Setting up Home Connect

Requirement: The appliance is receiving signals from the WLAN home network (Wi-Fi) at its installation location.

1. Scan the following QR code.



You can install the Home Connect app and connect your appliance via the QR code.

2. Follow the instructions in the Home Connect app.

10.3 Switching on the connection to the WLAN home network (Wi-Fi)

- ▶ Press .

10.4 Switching off the connection to the WLAN home network (Wi-Fi)

- ▶ Press .

10.5 Installing updates for the Home Connect software

Note: If an update of the Home Connect software is available, a message appears in the Home Connect app.



- ▶ To install the update for the Home Connect software, follow the instructions in the Home Connect app.
- ✓ The control panel is partially locked during the installation.

10.6 Resetting Home Connect settings

If your appliance experiences connection problems with the WLAN

¹ Wi-Fi is a registered trademark of the Wi-Fi Alliance.

home network (Wi-Fi) or your appliance wants to log into a different WLAN home network (Wi-Fi), you can reset the Home Connect settings.

- ▶ Press and hold  for six seconds until  goes out.
- ✓ The Home Connect settings have been reset.

10.7 Remote diagnostics

Customer Service can use Remote Diagnostics to access your appliance if you contact them, have your appliance connected to the Home Connect server and if Remote Diagnostics is available in the country in which you are using the appliance.

Tip: For further information and details about the availability of Remote Diagnostics in your country, please visit the service/support section of your local website: *www.home-connect.com*.

10.8 Data protection

Please see the information on data protection.

The first time your appliance is registered on a home network connected to the Internet, your appliance will transmit the following types of data to the Home Connect server (initial registration):

- Unique appliance identification (consisting of appliance codes as well as the MAC address of the installed Wi-Fi communication module).
- Security certificate of the Wi-Fi communication module (to ensure a secure data connection).
- The current software and hardware version of your appliance.
- Status of any previous resetting to factory settings.

This initial registration prepares the Home Connect functions for use and is only required when you want to use the Home Connect functions for the first time.

Note: Please note that the Home Connect functions can only be utilised with the Home Connect app. Information on data protection can be retrieved in the Home Connect app.

11 Refrigerator compartment

You can keep meat, sausage, fish, dairy products, eggs, prepared meals and pastries in the refrigerator compartment.

The temperature can be set from 2 °C (46 °F) to 8 °C (36 °F).

The refrigerator compartment can also be used to store highly perishable foods in the short to medium term. The lower the selected temperature, the longer the food remains fresh.

11.1 Tips for storing food in the refrigerator compartment

- Only store food when fresh and undamaged.
- Store food covered or in air-tight packaging.
- To avoid impeding the circulation of air and to prevent food from freezing, do not place food in front of the inner ventilation openings or in direct contact with the back wall.
- Allow hot food and drinks to cool down first before placing in the appliance.
- Observe the best-before date or use-by date specified by the manufacturer.

11.2 Chill zones in the refrigerator compartment

The air circulation in the refrigerator compartment creates different chill zones.

Coldest zone

The coldest zone is in the storage container.

Tip: Store highly perishable food such as fish, sausages and meat in the coldest zone.

Warmest zone

The warmest zone is at the very top of the door.

Tip: Store food that does not spoil easily in the warmest zone, e.g. hard cheese and butter. Cheese can then continue to release its aroma and the butter will still be easy to spread.

12 Freezer compartment

You can store frozen food, freeze food and make ice cubes in the freezer compartment.

The temperature can be set from $-16\text{ }^{\circ}\text{C}$ ($3\text{ }^{\circ}\text{F}$) to $-24\text{ }^{\circ}\text{C}$ ($-11\text{ }^{\circ}\text{F}$). Long-term storage of food should be at $-18\text{ }^{\circ}\text{C}$ ($0\text{ }^{\circ}\text{F}$) or lower.

The freezer compartment can be used to store perishable food long-term. The low temperatures slow down or stop the spoilage.

12.1 Freezing capacity

The freezing capacity indicates the quantity of food that can be frozen right through to the centre within a specific period of time. Information on freezing capacity can be found on the rating plate.

→ "Appliance", Fig. **1**/**9** Page 13

Prerequisites for freezing capacity

1. Approx. 24 hours before placing fresh food in the appliance, switch on Super freezing.
→ "Switching on manual Super freezing", Page 20
2. First, place the food on the freezer tray.

12.2 Fully utilising the freezer compartment volume

Learn how to store the maximum amount of frozen food in the freezer compartment.

1. Remove all fittings from the freezer compartment. → Page 30
2. Stack food directly on the floor of the freezer compartment.

12.3 Tips for storing food in the freezer compartment

- Store food in air-tight packaging.
- Do not bring food which is to be frozen into contact with frozen food.
- Place the food over the whole area of the freezer tray or the frozen food containers.
- To ensure that the air can circulate freely in the appliance, push the frozen food containers in as far as they will go.

12.4 Tips for freezing fresh food

- Freeze fresh and undamaged food only.
- Freeze food in portions.
- Cooked food is more suitable than food that can be eaten raw.
- Vegetables: Wash, chop up and blanch before freezing.
- Fruit: Wash, pit and perhaps peel, possibly add sugar or ascorbic acid solution.

- Food that is suitable for freezing includes baked items, fish and seafood, meat, game, poultry, eggs without shells, cheese, butter and quark, ready meals and leftovers.
- Food that is unsuitable for freezing includes lettuce, radishes, eggs in shells, grapes, raw apples and pears, yoghurt, sour cream, crème fraîche and mayonnaise.

Packing frozen food

If you select suitable packaging material and the correct type of packaging, you can determine the product quality and prevent freezer burn.

1. Place the food in the packaging.
2. Squeeze out the air.
3. Pack food airtight to prevent it from losing flavour and drying out.
4. Label the packaging with the contents and the date of freezing.

12.5 Shelf life of frozen food at -18 °C (0 °F)

Food	Storage time
Fish, sausages, prepared meals and baked goods	up to 6 months
Poultry, meat	up to 8 months
Vegetables, fruit	up to 12 months

The imprinted freezer calendar indicates the maximum storage duration in months at a constant temperature of -18 °C (0 °F).

12.6 Defrosting methods for frozen food

CAUTION

Risk of harm to health!

During the thawing process, bacteria may multiply and spoil the frozen food.

- ▶ Do not refreeze food after it has been defrosted or started to defrost.
- ▶ Refreeze food only after cooking.
- ▶ These items should no longer be stored for the maximum storage period.
- Defrost animal-based food, such as fish, meat, cheese, quark, in the refrigerator compartment.
- Defrost bread at room temperature.
- Prepare food for immediate consumption in the microwave, in the oven, or on the hob.

13 Water system

Your appliance is equipped with water-carrying components.

The water system only works if a water filter or a bypass cap is installed. Switch off ice cube production before disconnecting the appliance from the drinking water connection.

13.1 Water filter

The water filter filters particles and the taste of chlorine out of the water. The water filter reduces further contamination, e.g. from chloramines, lead and pharmaceutical products.

Note: The water filter does not filter bacteria or microbes out of the water.

Change the water filter:

- Every 6 months.
- If "filter" lights up.

en Water system

- If the water output has visibly reduced.
- If ice cube production has visibly reduced.

Tips

- A new water filter can be purchased from our customer service, your dealer or our website.
- If you do not want to use a water filter in your appliance or an external water filter system is installed, you can permanently replace the water filter with a bypass cap.
The bypass cap filters only large particles out of the water and can be cleaned as required.
A bypass cap can be purchased from customer service or our website.

Filter change notification

Every six months, the filter change notification is switched on. "filter" lights up.

Note: Increased water consumption switches the filter change notification on sooner.

Switching off the filter change notification

1. Replace the water filter.
The bypass cap does not need to be replaced.
2. Press **filter**.
 - ✓ "filter" goes out.
 - ✓ The filter change status is reset.

Changing the water filter or replacing it with a bypass cap

1. Reach into the recess below the filter cover ①, pull it forwards slightly and move it to the bottom left ②.

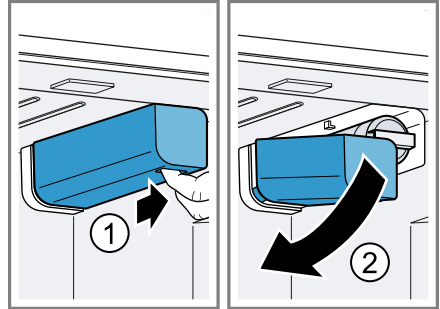

2. Pull the water filter down to the left ①, turn it counterclockwise by 90° ② and remove it ③.
 - ▶ Remove the water filter with care as it is under pressure.

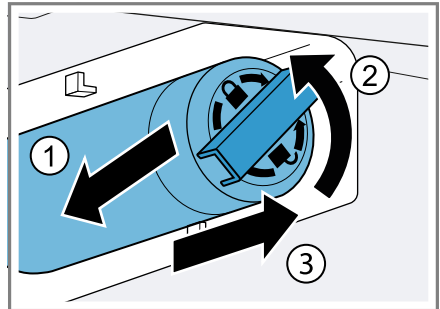

Note: When removing it, a small amount of water may drip out of the water filter. Remove the drips of water with a dry cloth.

Tip: You can dispose of the old water filter with your household waste.

3. Insert the new water filter or the bypass cap all the way into the filter opening, turn it 90° clockwise all the way and fold it up to the right.
4. Move the filter cover up to the right and slide it back as far as it will go.

- Discard the ice cubes produced during the first 24 hours, and dispense water for five minutes and then dispose of this.

13.2 Ice and water dispenser

Use the ice and water dispenser to dispense ice cubes, crushed ice and chilled water.

To achieve maximum ice cube production within a period of 24 hours, empty the ice storage container every 4 hours.

The quantity of ice cubes produced can vary due to the following conditions:

- Regularity with which the appliance is opened
- Amount of food stored
- Ambient temperature and ambient humidity
- Water pressure and condition of the water filter

Note: The ice and water dispenser is locked when the appliance door is open.

Putting the ice and water dispenser into operation

Notes

- Ice cube production starts as soon as the appliance is switched on and the freezer compartment has reached the set temperature.
- As soon as the freezer compartment reaches the set temperature, the first batch of ice cubes will be ready in approximately 4 hours.
- Once the appliance has been connected or a new water filter has been installed, there will be air in the water system.

Requirement: The appliance is connected to the drinking water connection.

- Keep dispensing water until it contains no more air bubbles. Remove any splashes of water with a dry cloth.
- For hygiene reasons, dispense water for 5 minutes and discard.
- For hygiene reasons, discard the ice cubes produced within the first 24 hours.

Dispensing ice or water

- To activate setting mode, touch the lower area of the control panel.
- Press the required selection option ① and press the glass against the dispensing button ②.
 - Flush the water system if water has not been drawn for 5 days. To flush the water system, dispense 2 litres of water.

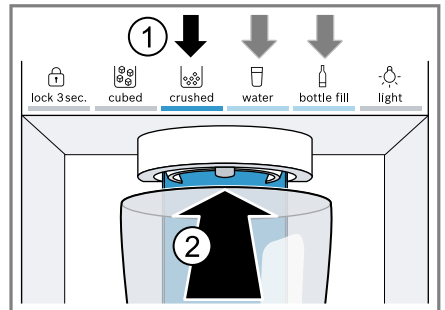



Tip: Hold the glass directly under the dispenser opening.

Notes

- After a while of continuous dispensing, the ice or water stops being dispensed. Wait a few seconds before dispensing ice or water again.
- After ice or water has been dispensed several times consecutively, it stops being dispensed. Wait a few minutes before dispensing ice or water again.
- When changing from **cubed** to **crushed**, a few ice cubes may

be released the next time you dispense.



- When changing from  **crushed** to  **cubed**, a small amount of crushed ice may be released the next time you dispense.

Bottle fill option

You can dispense a specific amount of water with the bottle fill option.

Note: The factory-set amount of water is approx. 500 ml.

Filling a bottle

1. Press  **bottle fill**.
2. Place a bottle or jug under the dispenser opening.
3. Press  **bottle fill**.

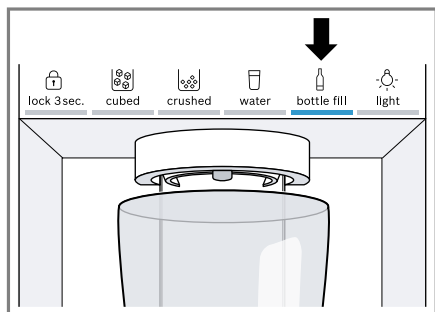

- ✓ The set amount of water is dispensed.

Tips



- To stop dispensing early, press any touch field on the control panel.
- To start dispensing again, press  **bottle fill**.

Note: If you do not fill a bottle for some time, the selection option changes to  **water**.

Setting the amount of water for the bottle fill option

Note: The maximum fill time is 60 seconds.

1. Press  **bottle fill**.



2. Place a bottle or jug under the dispenser opening.
 3. Select one of the options:
 - ▶ Press and hold  **bottle fill** at the same time until the desired amount of water is dispensed.
 - ▶ Press  (Freezer compartment) repeatedly until the temperature display (freezer compartment) shows the required water dispensing time in seconds.
- ✓ The new amount of water is saved and will be dispensed for the bottle fill option.

Permanent light



If you do not dispense ice or water for some time, the light switches itself off.

You can permanently switch on the light on the ice and water dispenser.

Switching on the permanent light

1. To activate setting mode, touch the lower area of the control panel.
 2. Press  **light**.
- ✓  **light** lights up.

Switching off the permanent light

1. To activate setting mode, touch the lower area of the control panel.
 2. Press  **light**.
- ✓  **light** goes out.

Switching on ice cube production

1. To activate setting mode, touch the upper area of the control panel.
 2. Press **icemaker off**.
- ✓ Ice cube production starts and the selection option that was last used lights up.

Switching off ice cube production

1. To activate setting mode, touch the upper area of the control panel.

2. Press **icemaker off**.
 - ✓ The ice dispenser and ice cube production stop.

14 Defrosting

14.1 Defrosting in the refrigerator compartment

The refrigerator compartment in your appliance defrosts automatically.

14.2 Defrosting in the freezer compartment

The fully automatic NoFrost system ensures that the freezer compartment remains frost-free. Defrosting is not required.

15 Cleaning and servicing

To keep your appliance working efficiently for a long time, it is important to clean and maintain it carefully. Customer Service must clean inaccessible points. Cleaning by customer service can give rise to costs.

15.1 Preparing the appliance for cleaning

1. Switch off the appliance.
→ *Page 18*
2. Disconnect the appliance from the power supply.
Unplug the appliance from the mains or switch off the circuit breaker in the fuse box.
3. Take out all of the food and store it in a cool place.
Place ice packs (if available) onto the food.
4. Remove all fittings and accessories from the appliance.
→ *Page 30*

5. Remove the shelf above the fruit and vegetable container.
→ *Page 32*
6. Remove the fruit and vegetable container cover.

15.2 Cleaning the appliance

WARNING

Risk of electric shock!

An ingress of moisture can cause an electric shock.

- ▶ Do not use steam- or high-pressure cleaners to clean the appliance.

Liquid in the lighting or in the controls can be dangerous.

- ▶ The rinsing water must not drip into the lighting or controls.

ATTENTION

Unsuitable cleaning products may damage the surfaces of the appliance.

- ▶ Do not use hard scouring pads or cleaning sponges.
- ▶ Do not use harsh or abrasive detergents.
- ▶ Do not use cleaning products with a high alcohol content.
- ▶ Do not use stainless-steel cleaning agents on the outside of the appliance.

If you clean fittings and accessories in the dishwasher, this may cause them to become deformed or discoloured.

- ▶ Never clean fittings and accessory in the dishwasher.

1. Prepare the appliance for cleaning.
→ *Page 29*
2. Clean the outside of the appliance, the inside of the appliance, the fittings, the accessories and the door seals with a dish cloth, lukewarm water and a little pH-neutral detergent.

en Cleaning and servicing

3. Dry thoroughly with a soft, dry cloth.
4. Insert the fittings and install the removable appliance parts.
5. Electrically connect the appliance.
→ Page 11
6. Putting the food into the appliance.

15.3 Removing the fittings

If you want to clean the fittings thoroughly, remove these from your appliance.

Removing the shelf

- ▶ Lift the shelf ① and remove it ②.

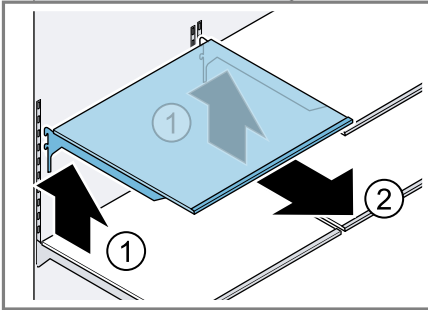

Removing door tray

- ▶ Lift the door tray and remove it.

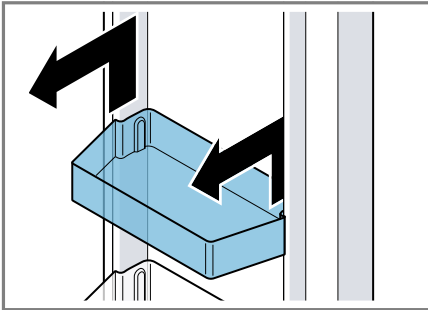

Removing the storage container

1. Pull out the storage container as far as it will go.
2. Lift the storage container at the front ① and remove it ②.

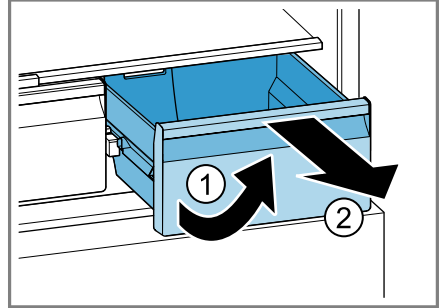

Removing the fruit and vegetable container

1. Pull out the fruit and vegetable container as far as it will go.
2. Lift the fruit and vegetable container at the front ① and remove it ②.

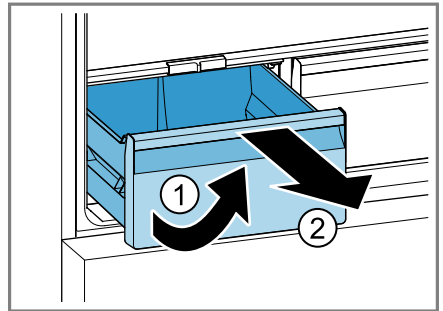

Removing the freezer tray

1. Pull out the freezer tray as far as it will go.

- Lift the freezer tray at the front ① and remove it ②.

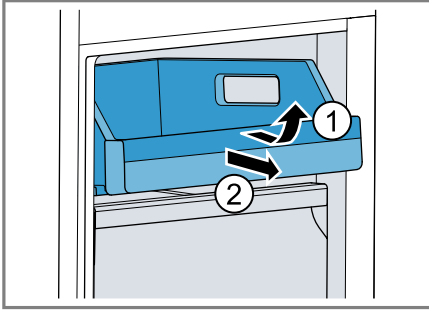

Removing the frozen food container

- Take out the frozen food container as far as it will go.
- Lift the frozen food container at the front ① and remove it ②.

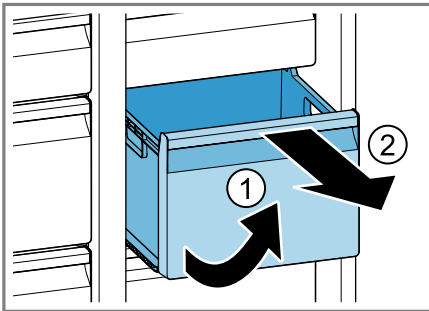

Removing the ice storage container

⚠ WARNING Risk of injury!

Reaching into the dispenser opening of the ice storage container can cause cuts.

- ▶ Never reach into the dispenser opening of the ice storage container.

- ▶ Reach into the left and right recesses below the ice storage container and take it out towards the front.

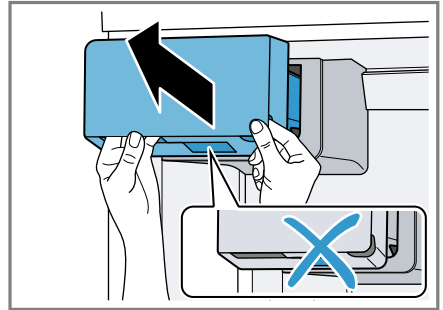

Tips

- If the ice storage container cannot be reinserted, turn the auger on the ice storage container and try again.

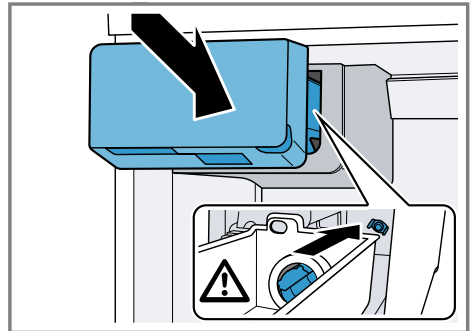

- If, during fitting, the ice storage container is blocked, remove the excess ice cubes from the ice storage container opening.

15.4 Removing appliance components

If you want to clean your appliance thoroughly, you can remove certain components from your appliance.

Removing the shelf above the fruit and vegetable container

- ▶ Lift the shelf above the fruit and vegetable container at the front ① and remove it ②.

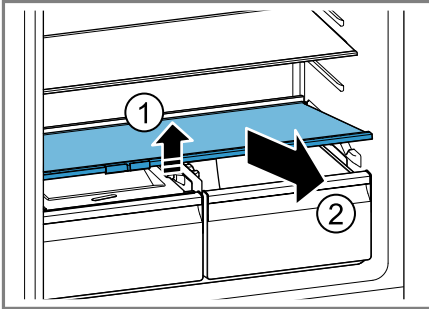

Removing the fruit and vegetable container cover

1. Pull out the fruit and vegetable container as far as it will go.
2. Lift the fruit and vegetable container cover slightly ①, pull it forwards ② and remove it ③.

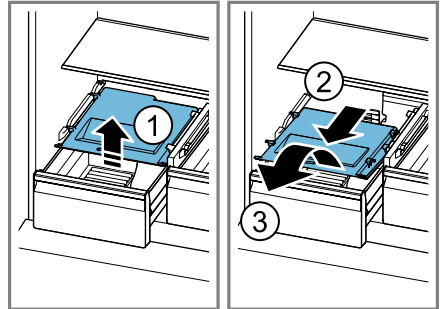

16 Troubleshooting

You can rectify minor faults on your appliance yourself. Read the troubleshooting information before contacting after-sales service. This will avoid unnecessary costs.



⚠ WARNING

Risk of electric shock!

Improper repairs are dangerous.

- ▶ Repairs to the appliance should only be carried out by trained specialist staff.
- ▶ Only use genuine spare parts when repairing the appliance.
- ▶ If the power cord or the appliance power cable of this appliance is damaged, it must be replaced with a special power cord or special appliance power cable, which is available from the manufacturer or its Customer Service.

Fault	Cause and troubleshooting
The appliance is not cooling, the displays and lighting are lit.	<p>Showroom mode is switched on.</p> <ol style="list-style-type: none"> 1. Disconnect the appliance from the mains. Unplug the appliance from the mains or switch off the circuit breaker in the fuse box. 2. Reconnect the appliance after five minutes. 3. Wait at least 30 seconds and then press ##CP0434SYB## for 15 seconds. <p>✓ ⏏ appears briefly on the control panel.</p> <ol style="list-style-type: none"> 4. After a short time, check whether your appliance is cooling.

Fault	Cause and troubleshooting
The LED lighting does not work.	<p>Different causes are possible.</p> <ul style="list-style-type: none"> ▶ Call customer service. The customer service number can be found in the enclosed customer service directory.
The refrigeration unit is switching on more frequently and for longer.	<p>The appliance has been opened frequently.</p> <ul style="list-style-type: none"> ▶ Do not open appliance door unnecessarily. <p>External ventilation openings are covered up.</p> <ul style="list-style-type: none"> ▶ Remove any obstructions from in front of the external ventilation openings.
	<p>Not a fault. Modern refrigeration machines switch on more frequently and have different power levels to cool more efficiently.</p>  <ul style="list-style-type: none"> ▶ Remove any obstructions from in front of the external ventilation openings. ▶ Install the appliance as far away as possible from heating elements, cookers and other heat sources. Avoid prolonged exposure of the appliance to direct sunlight. ▶ Only open the appliance door as briefly as necessary. ▶ Allow hot food and drinks to cool down first before storing in the appliance.
A layer of frost forms on the back wall of the refrigerator compartment.	<p>Not a fault. Modern refrigeration machines ensure a more even temperature in the refrigerator compartment. The back wall of the refrigerator compartment is defrosted automatically at regular intervals.</p>  <ul style="list-style-type: none"> ▶ Only open the appliance door as briefly as necessary. ▶ Pack the food airtight or cover it. ▶ Allow hot food and drinks to cool down first before storing in the appliance. ▶ Always leave some space between the food and the interior walls.
Home Connect is not working properly.	<p>Different causes are possible.</p> <ul style="list-style-type: none"> ▶ Go to www.home-connect.com.

Fault	Cause and troubleshooting
<p>"E" or "d" appears on the temperature display.</p>	<p>The electronics have detected a fault.</p> <ol style="list-style-type: none"> 1. Switch off the appliance. → <i>Page 18</i> 2. Disconnect the appliance from the mains. Unplug the appliance from the mains or switch off the circuit breaker in the fuse box. 3. Reconnect the appliance after five minutes. 4. If the message still appears on the display, call Customer Service. The customer service number can be found in the enclosed customer service directory.
<p>A warning signal sounds and "alarm" flashes. The door alarm is switched on.</p>	<p>The appliance door is open.</p> <ul style="list-style-type: none"> ▶ Close the appliance door.
<p>A warning tone sounds and the temperature display (freezer compartment) and "alarm" flash. The temperature alarm is switched on.</p>	<p>Different causes are possible.</p> <ol style="list-style-type: none"> 1. Press alarm. ✓ The alarm is switched off. 2. After several hours, check whether the set freezer compartment temperature has been reached again. <hr/> <p>External ventilation openings are covered up.</p> <ul style="list-style-type: none"> ▶ Remove any obstructions from in front of the external ventilation openings. <hr/> <p>Larger quantities of fresh food have been put in.</p> <ul style="list-style-type: none"> ▶ Switch on Super freezing before placing a larger amount of food in the appliance. → <i>"Switching on manual Super freezing", Page 20</i>
<p>All temperature displays and "alarm" light up.</p>	<p>A sensor is defective.</p> <ul style="list-style-type: none"> ▶ Call customer service. The customer service number can be found in the enclosed customer service directory.
<p>The temperature differs greatly from the setting.</p>	<p>Different causes are possible.</p> <ol style="list-style-type: none"> 1. Switch off the appliance. → <i>Page 18</i> 2. Switch the appliance back on after five minutes. → <i>Page 17</i> <ul style="list-style-type: none"> ▶ If the temperature is too warm, check the temperature again after a couple of hours. ▶ If the temperature is too cold, check the temperature again on the following day.
<p>Water is leaking out of the appliance.</p>	<p>The water connection or water hose is not leak-tight.</p> <ul style="list-style-type: none"> ▶ Check if the water connections are fastened firmly and the water hose is undamaged. If necessary, replace the water hose.

Fault	Cause and troubleshooting
<p>Water output is reduced.</p>	<p>Low water pressure.</p> <ul style="list-style-type: none"> ▶ Check the water pressure of the water supply system or the external water filter system, e.g. reverse osmosis system. Connect the appliance only to a water connection with sufficient water pressure. → <i>Page 8</i> <hr/> <p>The water filter is blocked.</p> <ul style="list-style-type: none"> ▶ Change the water filter. → <i>Page 26</i>
<p>Water is dripping from the ice and water dispenser.</p>	<p>Air is in the water system.</p> <ul style="list-style-type: none"> ▶ Keep dispensing water until it contains no more air. <hr/> <p>Ice residue is melting in the ice chute.</p> <ul style="list-style-type: none"> ▶ Remove the ice residue from the ice chute, for example using a wooden spoon. <div data-bbox="393 563 736 810" data-label="Image"> <p>The diagram shows a cross-section of an ice dispenser chute. A blue ice cube is positioned at the bottom of the chute. A large black arrow points downwards from the top of the chute towards the ice cube, indicating the direction of ice flow or the location of the residue to be removed.</p> </div>
<p>Condensation forms at the ice storage container's outlet opening and the ice shaft.</p>	<p>The water contained in warm and humid air condenses on the colder surfaces of the appliance.</p> <ul style="list-style-type: none"> ▶ Do not open appliance door unnecessarily. <hr/> <p>Ice residue is melting in the ice chute.</p> <ol style="list-style-type: none"> 1. Wipe away the condensation water with a soft, dry cloth. 2. Open the appliance as briefly as possible. 3. Ensure that the appliance is always closed properly.
<p>Ice cube production is low.</p>	<p>The appliance has only recently been connected.</p> <ul style="list-style-type: none"> ▶ Wait approximately four hours until the first batch of ice cubes is ready. <hr/> <p>The freezer compartment has been opened frequently or for an extended period of time.</p> <ul style="list-style-type: none"> ▶ Check ice cube production after a few hours.
<p></p>	<p>Low water pressure.</p> <ul style="list-style-type: none"> ▶ Check the water pressure of the water supply system or the external water filter system, e.g. reverse osmosis system. Connect the appliance only to a water connection with sufficient water pressure. → <i>Page 8</i>

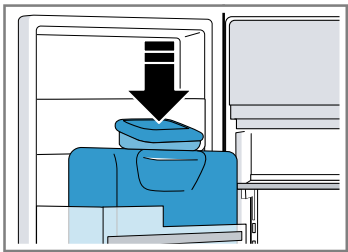
Fault	Cause and troubleshooting
Ice cube production is low.	<p>The water filter is blocked.</p> <ul style="list-style-type: none"> ▶ Change the water filter. → <i>Page 26</i>
The ice and water dispenser is not functioning.	<p>Ice cube production is switched off.</p> <ul style="list-style-type: none"> ▶ Switch on ice cube production. <p>The keylock is switched on</p> <ul style="list-style-type: none"> ▶ Switch off the button lock. → <i>Page 19</i>
	<p>The ice storage container is not fully inserted.</p> <ul style="list-style-type: none"> ▶ Fully insert the ice storage container. → <i>Page 31</i>
	<p>Ice cubes are frozen together in the ice chute.</p> <ul style="list-style-type: none"> ▶ Remove the ice cubes from the ice chute, for example using a wooden spoon.
	
	<p>Low water pressure.</p> <ul style="list-style-type: none"> ▶ Check the water pressure of the water supply system or the external water filter system, e.g. reverse osmosis system. <p>Connect the appliance only to a water connection with sufficient water pressure. → <i>Page 8</i></p>
	<p>The water filter is blocked.</p> <ul style="list-style-type: none"> ▶ Change the water filter. → <i>Page 26</i>
	<p>There is no water supply.</p> <ul style="list-style-type: none"> ▶ Ensure that there is a water supply and that the corner valve on the water connection is open. <p>Contact an installer if necessary.</p>
	<p>Kink in the water hose.</p> <ul style="list-style-type: none"> ▶ Turn off the water supply and straighten the kink in water hose. <p>If necessary, replace the water hose.</p>

Fault	Cause and troubleshooting
<p>The ice and water dispenser is not functioning.</p>	<p>Fault in the ice and water dispenser.</p> <ol style="list-style-type: none"> 1. Switch off the appliance. → <i>Page 18</i> 2. Disconnect the appliance from the mains. Unplug the appliance from the mains or switch off the circuit breaker in the fuse box. 3. Reconnect the appliance after five minutes. 4. If the fault persists, call customer service. The customer service number can be found in the enclosed customer service directory.
<p>The appliance hums, bubbles, buzzes, gargles, clicks, crackles or rumbles.</p>	<p>Not a fault. A motor is running, e.g. refrigerating unit, fan. Refrigerant flows through the pipes. The motor, switches, solenoid valves or water valves are switching on or off. Automatic defrosting is running. Ice cubes fall into the ice storage container. No action required.</p>
<p>The appliance makes noises.</p> 	<p>The appliance is not level.</p> <ul style="list-style-type: none"> ▶ Align the appliance using a spirit level and the screw feet. <hr/> <p>The appliance is not free-standing.</p> <ul style="list-style-type: none"> ▶ Observe the minimum clearances for the appliance. <hr/> <p>Fittings wobble or stick.</p> <ul style="list-style-type: none"> ▶ Check the removable fittings and, if required, replace these. <hr/> <p>Bottles or containers are touching.</p> <ul style="list-style-type: none"> ▶ Move the bottles or containers away from each other. <hr/> <p>Super freezing is switched on. No action required.</p>

16.1 Power failure

During a power failure, the temperature in the appliance rises; this reduces the storage time and the quality of the frozen food.

On the website for your appliance, the technical data provides you with the storage times for frozen food in the event of a fault.

Notes

- Open the appliance as little as possible during a power failure and do not place any other food in the appliance.

- Check the quality of the food immediately after a power failure.
 - Dispose of any frozen food that has defrosted and is hotter than 5 °C.
 - Cook or fry slightly thawed frozen food, and then either consume it or freeze it again.

16.2 Conducting an appliance self-test

Your appliance has an appliance self-test which displays faults that can be eliminated by your customer service.

en Storage and disposal

1. Switch off the appliance.
→ *Page 18*
2. Disconnect the appliance from the power supply.
Unplug the appliance from the mains or switch off the circuit breaker in the fuse box.
3. Electrically reconnect the appliance after 5 minutes. → *Page 11*
- ✓ The control panel shows an animation and is locked.
4. One minute after switching on, press and hold **super** (Refrigerator compartment) for 3 to 5 seconds until an audible signal sounds.
- ✓ The appliance self-test starts.
- ✓ If, at the end of the appliance self-test, 2 audible signals sound and the temperature display indicates the set temperature, the temperature sensors on your appliance are OK. The appliance switches to normal operation.
- ✓ If, at the end of the appliance self-test, 5 audible signals sound, inform customer service.
5. Press **super** (Freezer compartment) so that the appliance skips to normal operation.
- ✓ The temperature displays show the set temperatures → *Page 18*.

17 Storage and disposal

17.1 Taking the appliance out of operation

1. Switch off the appliance.
→ *Page 18*
2. Disconnect the appliance from the power supply.
Unplug the appliance from the mains or switch off the circuit breaker in the fuse box.
3. Disconnect the appliance from the drinking water connection.

4. Remove all of the food.
5. Remove the water filter. → *Page 26*
6. Clean the appliance. → *Page 29*
7. **ATTENTION** – Objects jammed between the door and the housing may damage the door hinge.
 - ▶ Open the door until it remains open by itself.
 - ▶ Do not insert any objects between the door and the housing.

To guarantee the ventilation inside the appliance, leave the appliance open.

17.2 Disposing of old appliance

Valuable raw materials can be re-used by recycling.

WARNING

Risk of harm to health!

Children can lock themselves in the appliance, thereby putting their lives at risk.

- ▶ Leave shelves and containers inside the appliance to prevent children from climbing in.
- ▶ Keep children away from the redundant appliance.

WARNING

Risk of fire!

If the tubes are damaged, flammable refrigerant and harmful gases may escape and ignite.

- ▶ Do not damage the tubes of the refrigerant circuit or the insulation.

1. Unplug the appliance from the mains.
2. Cut through the power cord.
3. Dispose of the appliance in an environmentally friendly manner.
Information about current disposal methods are available from your specialist dealer or local authority.



This appliance is labelled in accordance with European Directive

2012/19/EU concerning used electrical and electronic appliances (waste electrical and electronic equipment - WEEE).

The guideline determines the framework for the return and recycling of used appliances as applicable throughout the EU.

18 Customer Service

Function-relevant genuine spare parts according to the corresponding Eco-design Order can be obtained from Customer Service for a period of at least 10 years from the date on which your appliance was placed on the market within the European Economic Area.

Note: Under the terms of the manufacturer's warranty applicable to the location, the use of Customer Service is free of charge. The minimum duration of the warranty (manufacturer's warranty for private consumers) in the European Economic Area is 2 years according to the terms of warranty applicable to the location. The terms of warranty do not affect other rights or claims held by yourself under local legislation.

Detailed information about the warranty period and the warranty conditions in your country is available via the QR code on the enclosed document on service contacts and war-

ranty conditions, from our customer service or on our website.

If you contact Customer Service, you will require the product number (E-Nr.), the production number (FD) and the consecutive numbering (Z-Nr.) of your appliance.

You can find the contact details for our customer service via the QR code on the enclosed document on service contacts and warranty conditions or on our website.

18.1 Product number (E-Nr.), production number (FD) and consecutive numbering (Z-Nr.)

You can find the product number (E-Nr.), the production number (FD) and the consecutive numbering (Z-Nr.) on the appliance's rating plate.

→ "Appliance", Fig. 1/9 Page 13

Make a note of your appliance's details and the Customer Service telephone number to find them again quickly.

19 Technical data

Refrigerant, cubic capacity and further technical specifications can be found on the rating plate.

→ "Appliance", Fig. 1/9 Page 13

This product contains a second light source from energy efficiency class G. The light source is available as a spare part and should only be replaced by trained specialist staff.

You can find more information about your model online at <https://eprel.ec.europa.eu/>¹. This web address is linked to the official EU

¹ Only applies to countries in the European Economic Area

EPREL product database. Please then follow the instructions on searching for the model. The model identifier is made up of the characters before the slash in the product number (E-Nr.) on the rating plate. Alternatively, you can also find the model identifier in the first line of the EU energy label.

19.1 Information regarding Free and Open Source Software

This product includes software components that are licensed by the copyright holders as free or open source software.

The applicable licence information is stored on your home appliance. You can also access the applicable licence information via your Home Connect app: "Profile -> Legal information -> Licence Information".¹

You can download the licence information on the brand product website. (Please search on the product website for your appliance model and additional documents). Alternatively, you can request the relevant information from oss-request@bshg.com or BSH Hausgeräte GmbH, Carl-Wery-Str. 34, 81739 Munich, Germany.

The source code will be made available to you on request.

Please send your request to oss-request@bshg.com or BSH Hausgeräte GmbH, Carl-Wery-Str.34, 81739 Munich, Germany.

Subject: „OSSREQUEST“

The cost of performing your request will be charged to you. This offer is valid for three years from the date of purchase or at least as long as we offer support and spare parts for the relevant appliance.

20 Declaration of Conformity

BSH Hausgeräte GmbH hereby declares that the appliance with Home Connect functionality conforms to the essential requirements and other relevant provisions of Directive 2014/53/EU.

A detailed RED Declaration of Conformity can be found online at www.bosch-home.com among the additional documents on the product page for your appliance.



Hereby, BSH Hausgeräte GmbH declares that the appliance with Home Connect functionality is in compliance with relevant statutory requirements.²

A detailed Declaration of Conformity can be found online at www.bosch-home.co.uk among the additional documents on the product page for your appliance.²



¹ Depending on the appliance specifications

² Only applies to Great Britain

2.4 GHz band (2400–2483.5 MHz): Max. 100 mW

5-GHz band (5150–5350 MHz + 5470–5725 MHz): max. 150 mW

	BE	BG	CZ	DK	DE	EE	IE	EL	ES
	FR	HR	IT	CY	LI	LV	LT	LU	HU
	MT	NL	AT	PL	PT	RO	SI	SK	FI
	SE	NO	CH	TR	IS	UK (NI)			

5 GHz WLAN (Wi-Fi): For indoor use only.

AL	BA	MD	ME	MK	RS	UK	UA
----	----	----	----	----	----	----	----

5 GHz WLAN (Wi-Fi): For indoor use only.

20.1 Statement of Compliance for Great Britain

The full Statement of Compliance according to the Product Security and Telecommunications Infrastructure (Security Requirements for Relevant Connectable Products) Regulations 2023 can be found online at www.bosch-home.co.uk among the additional documents on the product page for your appliance.

Product type

This statement of compliance covers the products described in this information for use whose model identifier group is seen on the title page. The full model identifier is made up of the characters before the slash in the product number (E no.) which can be found on the rating plate. Alternatively, you can also find the model identifier in the first line of the UK Energy Label.

Name and address of manufacturer

BSH Hausgeräte GmbH, Carl-Wery-Strasse 34, 81739 München, Germany

This statement of compliance is prepared by the manufacturer.

The manufacturer, BSH Hausgeräte GmbH deems that it has complied with

- provision 5.1-1 of ETSI EN 303 645 v2.1.1 and, where relevant, provision 5.1-2 of ETSI EN 303 645 v2.1.1;
- provision 5.2-1 of ETSI EN 303 645 v2.1.1;
- provision 5.3-13 of ETSI EN 303 645 v2.1.1.

Support period

BSH Hausgeräte GmbH will provide security updates that are necessary to maintain the main functions free of charge until at least 28/02/2034.



Thank you for buying a Bosch Home Appliance!

Register your new device on MyBosch now and profit directly from:

- **Expert tips & tricks for your appliance**
- **Warranty extension options**
- **Discounts for accessories & spare-parts**
- **Digital manual and all appliance data at hand**
- **Easy access to Bosch Home Appliances Service**

Free and easy registration – also on mobile phones:

www.bosch-home.com/welcome



Looking for help? You'll find it here.

Expert advice for your Bosch home appliances, help with problems or a repair from Bosch experts.

Find out everything about the many ways Bosch can support you:

www.bosch-home.com/service

Contact data of all countries are listed in the attached service directory.

BSH Hausgeräte GmbH

Carl-Wery-Straße 34
81739 München, GERMANY
www.bosch-home.com

A Bosch Company

Valid within Great Britain:
Imported to Great Britain by
BSH Home Appliances Ltd.
Grand Union House
Old Wolverton Road
Wolverton, Milton Keynes
MK12 5PT
United Kingdom



9001945893 (050506)

en