

## Operating and installation instructions Steam oven with microwave

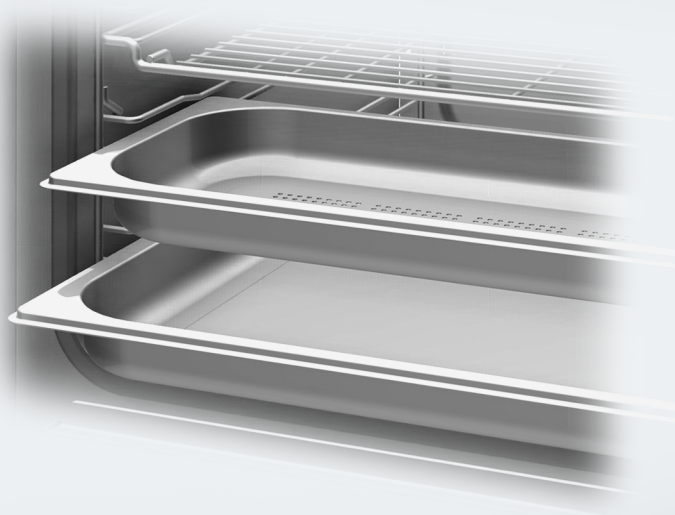

To prevent the risk of accidents or damage to the appliance, it is **essential** to read these instructions before it is installed and used for the first time.

# Contents

---

<b>Warning and Safety instructions</b> .....	6
<b>Caring for the environment</b> .....	18
<b>Overview</b> .....	19
Steam oven .....	19
Accessories supplied .....	20
<b>Controls</b> .....	22
On/Off sensor .....	23
Display.....	23
Sensor controls .....	23
Symbols.....	25
<b>Operating principles</b> .....	26
Selecting a menu option .....	26
Changing a setting in a list.....	26
Changing the setting with a segment bar .....	26
Selecting a function.....	27
Entering numbers .....	27
Entering letters .....	28
Activating MobileStart.....	28
<b>Description of the functions</b> .....	29
Steam cooking function .....	29
Water container .....	29
Temperature .....	29
Duration .....	29
Noises.....	29
Heating-up phase.....	30
Cooking phase .....	30
Steam reduction .....	30
Microwave power .....	31
How it works.....	31
Suitable crockery.....	31
Glass tray .....	36
Oven interior lighting .....	36
<b>Before using for the first time</b> .....	37
Miele@home.....	37
Standard settings .....	38
Cleaning for the first time .....	39
Setting the correct boiling point for water.....	40

<b>Settings</b> .....	41
Settings overview .....	41
Opening the “Settings” menu.....	43
Language  .....	43
Time.....	43
Date .....	44
Lighting.....	44
Display.....	44
Volume.....	45
Units .....	45
Quick MW.....	46
Popcorn.....	46
Keeping warm .....	46
Steam reduction .....	47
Recommended temperatures.....	47
Recommended power levels.....	47
Water hardness .....	48
Safety .....	49
Miele@home.....	50
Remote control.....	51
Activating MobileStart .....	51
Remote update.....	51
Software version.....	52
Showroom programme.....	52
Factory default.....	52
<b>Minute minder</b> .....	53
<b>Main and sub-menus</b> .....	55
<b>Operation</b> .....	57
Changing values and settings for a cooking programme.....	58
Changing the temperature.....	59
Changing the microwave power level .....	59
Setting cooking durations .....	60
Changing the set cooking durations .....	61
Deleting the set cooking durations.....	62
Interrupting the cooking process for functions which use microwave power.....	62
Interrupting the cooking process for functions involving steam .....	63
Cancelling cooking.....	64
<b>Quick MW and Popcorn</b> .....	65
Quick MW.....	65
Popcorn.....	66

# Contents

---

<b>General notes on steam cooking</b> .....	67
The advantages of cooking with steam .....	67
Suitable containers.....	67
Glass tray .....	67
Shelf level .....	68
Frozen .....	68
Temperature .....	68
Duration .....	68
Cooking with liquid.....	68
Your own recipes .....	68
<b>Steam cooking</b> .....	69
Eco Steam cooking .....	69
Notes on the cooking charts .....	69
Vegetables.....	70
Fish.....	73
Meat .....	76
Rice .....	78
Grains .....	79
Pasta/Noodles.....	80
European dumplings .....	81
Dried pulses .....	82
Hen's eggs .....	84
Fruit .....	85
Sausages.....	85
Shellfish .....	86
Mussels .....	87
Menu cooking.....	88
<b>Sous-vide (vacuum) cooking</b> .....	90
<b>Other applications</b> .....	98
Reheat with steam.....	98
Defrost with steam .....	101
Blanch .....	104
Bottling .....	104
Disinfect items .....	107
Prove yeast dough .....	107
Heat damp towels .....	108
Dissolve gelatine .....	108
Decrystallise honey .....	109
Melt chocolate.....	109
Make yoghurt .....	110
Render fat.....	111

---

Sweat onions.....	111
Extracting juice.....	112
Skinning fruit and vegetables.....	113
Preserving apples .....	113
Preparing custard royale .....	113
<b>Rapid steam cooking .....</b>	<b>114</b>
Cooking new potatoes (firm) .....	115
Cooking rice .....	116
<b>Microwave defrosting and reheating.....</b>	<b>117</b>
Defrost.....	118
Reheat .....	122
<b>Automatic programmes .....</b>	<b>127</b>
Categories .....	127
Using Automatic programmes.....	127
<b>User programmes.....</b>	<b>128</b>
<b>Cleaning and care .....</b>	<b>131</b>
Cleaning the steam oven front .....	132
Cleaning the oven compartment.....	132
Cleaning the water container .....	133
Accessories .....	133
Cleaning the shelf runners.....	134
Maintenance.....	134
Descaling the steam oven .....	134
Soak .....	135
<b>Problem solving guide .....</b>	<b>136</b>
<b>Optional accessories .....</b>	<b>141</b>
<b>Service.....</b>	<b>142</b>
Contact in case of fault .....	142
Warranty .....	142
<b>Installation.....</b>	<b>143</b>
Safety instructions for installation .....	143
Building-in dimensions.....	144
Installation in a tall unit.....	144
Installation in a base unit.....	145
Side view .....	146
Connection and ventilation.....	147
Installing the steam oven.....	148
Electrical connection .....	149

## Warning and Safety instructions

---

The steam oven with microwave is referred to in the following instructions as steam oven.

This appliance complies with all current local and national safety requirements. However, inappropriate use can lead to personal injury and damage to property.

Please read these operating and installation instructions carefully before using the steam oven for the first time. They contain important information on safety, installation, use and maintenance of the appliance. This prevents both personal injury and damage to the steam oven.

In accordance with standard IEC 60335-1, Miele expressly and strongly advises that you read and follow the instructions in “Installation”, as well as in the “Warning and Safety instructions”.

Miele cannot be held liable for injury or damage caused by non-compliance with these instructions.

Keep these instructions in a safe place and pass them on to any future owner.

### Correct application

▶ This steam oven is designed for domestic use and for use in similar environments by guests in hotel or motel rooms, bed & breakfasts and other typical living quarters. This does not include common/shared facilities or commercial facilities within hotels, motels or bed & breakfasts.

▶ The steam oven is not suitable for outdoor use.

▶ The steam oven is intended only to steam, defrost, reheat and cook food.

Any other use is not permitted.

▶ Fire hazard due to flammable materials.

If flammable items were dried using microwave power, the moisture in the items would evaporate. This could cause the materials to dry out and possibly self-ignite.

Never use the steam oven to store or dry items which could ignite easily.

▶ This appliance is not intended for use by persons (including children) with reduced physical, sensory or mental capabilities, or lack of experience and knowledge, unless they have been given supervision or instruction concerning its use by a person responsible for their safety, and are able to recognise the dangers of misuse.

▶ The oven compartment is equipped with special lamps to cope with particular conditions (e.g. temperature, moisture, chemical resistance, abrasion resistance and vibration). These special lamps must only be used for the purpose for which they are intended. They are not suitable for room lighting. Replacement lamps may only be fitted by a Miele authorised technician or by Miele.

# Warning and Safety instructions

---

## Safety with children

- ▶ Activate the system lock to ensure that children cannot switch on the steam oven inadvertently.
- ▶ Young children must not be allowed to use this appliance.
- ▶ Older children may only use the appliance if its operation has been clearly explained to them and they are able to use it safely. They must be able to understand and recognise the possible dangers caused by incorrect operation.
- ▶ Cleaning may only be carried out by older children under the supervision of an adult.
- ▶ Please supervise children in the vicinity of the steam oven and do not let them play with it.
- ▶ Risk of suffocation from packaging material. Whilst playing, children may become entangled in packaging material (such as plastic wrapping) or pull it over their head with the risk of suffocation. Keep packaging material away from children.
- ▶ Risk of injury caused by hot surfaces and steam. Children's skin is far more sensitive to high temperatures than that of adults. During operation, steam will escape out of the ventilation outlet. The door glass and control panel of the steam oven heat up. Do not let children touch the steam oven when it is in operation. Keep children well away from the steam oven until it has cooled down and there is no danger of injury.
- ▶ Risk of injury from the open door. The oven door can support a maximum weight of 8 kg. Children could injure themselves on an open door. Do not let children sit on the open door, lean against it or swing on it.

### Technical safety

- ▶ Unauthorised installation, maintenance and repairs (including removal of any cover) can cause considerable danger for the user. Installation, maintenance and repairs must only be carried out by a Miele authorised technician.
- ▶ Radiation by microwaves:  
Service or repairs which necessitate the removal of any casing or the door must only be carried out by a suitably trained service technician.
- ▶ A damaged appliance is dangerous. Check the appliance for any visible damage. Never install or attempt to use a damaged appliance.
- ▶ Check the door and door seal for any sign of damage. If any damage is noticed, the oven should not be used again in any oven function using microwave power until the fault has been rectified by a service technician.
- ▶ Operating a damaged appliance can result in microwave leakage and present a hazard to the user. Do not use the steam oven if:
  - the door is warped,
  - the front of the oven compartment is dented or bowed,
  - the door hinges are loose,
  - holes or cracks are visible in the casing, the door, the door seal or the oven interior walls,
  - there is moisture between the door panes.
- ▶ Reliable and safe operation of this oven can only be assured if it has been connected to the mains electricity supply.

## Warning and Safety instructions

---

- ▶ The electrical safety of this appliance can only be guaranteed when continuity is complete between it and an effective earthing system. It is most important that this basic safety requirement is present and tested regularly and, where there is any doubt, the household wiring system should be inspected by a qualified electrician.
- ▶ Before connecting the appliance to the mains supply, ensure that the connection data on the data plate (voltage and frequency) matches the mains electricity supply. This data must correspond in order to avoid the risk of damage to the appliance. Consult a qualified electrician if in any doubt.
- ▶ Do not connect the appliance to the mains electricity supply by a multi-socket adapter or an extension lead. These do not guarantee the required safety of the appliance (e.g. danger of overheating).
- ▶ For safety reasons, this appliance may only be used after it has been built in.
- ▶ This appliance must not be installed and operated in mobile installations (e.g. on a ship).
- ▶ Tampering with electrical connections or components and mechanical parts is highly dangerous to the user and can cause operational faults. Do not open the outer casing of the appliance.
- ▶ The manufacturer's warranty will be invalidated if the appliance is not repaired by a Miele approved service technician.
- ▶ Faulty components must only be replaced by genuine Miele spare parts. The manufacturer can only guarantee the safety of the appliance when Miele replacement parts are used.
- ▶ If the plug has been removed or the connection cable is not supplied with a plug, the steam oven must be connected to the mains supply by a suitably qualified electrician.

## Warning and Safety instructions

---

- ▶ If the mains connection cable is damaged, it must be replaced with a special mains connection cable (see “Installation – Electrical connection”).
- ▶ During installation, maintenance and repair work, the appliance must be disconnected from the mains electricity supply. It is only completely isolated from the electricity supply when:
  - it is switched off at the mains circuit breaker, or
  - it is switched off at the wall socket and the plug is withdrawn from the socket. Do not pull the mains connection cable but the mains plug to disconnect your appliance from the mains electricity supply.
- ▶ If the steam oven is installed behind a furniture front (e.g. a door), do not close the furniture front while the steam oven is in use. Heat and moisture can build up behind a closed furniture door. This can result in damage to the steam oven, the housing unit and the floor. Leave the furniture door open until the steam oven has cooled down completely.
- ▶ In areas which may be subject to infestation by cockroaches or other vermin, pay particular attention to keeping the appliance and its surroundings clean at all times. Any damage caused by cockroaches or other vermin will not be covered by the warranty.

# Warning and Safety instructions

---

## Correct use



- ▶ Risk of injury caused by hot surfaces and steam. The steam oven gets hot during operation. You could burn yourself on the oven compartment, shelf runners, accessories, food or steam. Wear oven gloves when placing food in the oven or removing it, and when adjusting oven shelves etc. in a hot oven.
- ▶ Risk of injury caused by hot food. Food may spill or splash around when placing it into the oven or removing it. The food can cause burns. When placing cooking containers in the oven or removing them, make sure that the hot food does not spill.
- ▶ Risk of injury due to hot water. At the end of a cooking programme, hot water left in the steam generator is pumped back into the water container. Take care not to tip the water container when taking it out of the appliance.
- ▶ Do not use the steam oven to heat up or bottle food in sealed tins. Pressure will build up inside them and they can explode causing damage to the appliance, as well as the risk of injury and scalding.
- ▶ Plastic dishes which are not heat-resistant and steam-resistant melt at high temperatures and can damage the appliance. Use only heat-resistant (to 100 °C) and steam-resistant plastic dishes for steam cooking. Follow the manufacturer's instructions.
- ▶ Food which is left in the oven compartment can dry out and the moisture released can lead to corrosion damage in the steam oven. Do not leave food in the oven compartment and do not use any cooking containers which are susceptible to corrosion.
- ▶ Risk of injury from the open door. You could bang into the open door or trip over it. Avoid leaving the door open unnecessarily.

## Warning and Safety instructions

---

- ▶ The door can support a maximum load of 8 kg. Do not sit on or lean against an open door, and do not place heavy objects on it. Also make sure that nothing can get trapped between the door and the oven compartment. The steam oven could get damaged.
- ▶ When using a small electrical appliance, e.g. a hand-held blender, near the steam oven, care should be taken that the cable of the appliance cannot get trapped by the steam oven door. The insulation on the cable could become damaged, giving rise to an electric shock hazard.

### Microwave function

- ▶ Please be aware that durations when using microwave power are often considerably shorter when cooking, reheating and defrosting than when using functions without microwave power. Excessively long cooking times can lead to food drying out and burning or could even cause it to catch fire.
- ▶ The Microwave  function is used to reheat food and beverages. Do not use the Microwave  function for drying flowers, herbs, bread or other flammable materials which could catch fire and cause injury by burning.
- ▶ It is important that the temperature in the food being cooked is evenly distributed and sufficiently high. This can be achieved by stirring or turning the food, and observing a sufficiently long standing time (see charts), which should be added to the time needed for reheating, defrosting or cooking. During the standing time, the temperature is distributed evenly in the food.

## Warning and Safety instructions

---

▶ Risk of injury caused by hot food. When heating food up, the heat is created directly in the food itself. For this reason, the crockery will remain cooler than the food (except when using ovenproof stoneware). The crockery is only warmed by the heat of the food. Before serving, always check the temperature of the actual food itself after taking it out of the oven. The temperature of the container is not an indication of the temperature of the food or liquid in it. **This is particularly important when heating food for babies, children, and the elderly or infirm.** After reheating food, especially food for babies and small children, stir the food or shake the container and check that the temperature does not pose any danger of burning. Double check after it has been left to stand.



▶ The Microwave  function is not suitable for cleaning or disinfecting items because it may involve high temperatures. There is a risk of burning when items are removed from the oven.

▶ Risk of injury from increased pressure in sealed containers or bottles. Pressure can build up when reheating food or drinks in sealed containers, jars or bottles, which can cause them to explode. Never cook or reheat food or liquids in sealed containers or bottles. Open containers beforehand. In the case of baby bottles, the screw top and teat must be removed.

▶ When heating food, and in particular liquids, using the Microwave  function, the boiling point may be reached without the production of typical bubbles. Liquids do not boil evenly throughout. This boiling delay can result in the liquid boiling over explosively. Take care when taking the container out of the oven, as the hot liquid can cause severe scalding. Under certain circumstances, the pressure can be so high that the door opens automatically. Stir liquids well before reheating or cooking. After heating, wait at least 20 seconds before removing the container from the oven. In addition, a glass rod or similar item, if available, can be placed in the container during heating.

## Warning and Safety instructions

---

- ▶ Eggs can be cooked without their shells using microwave power only if the yolk membrane has been punctured several times first. The pressure could otherwise cause the egg yolk to explode.
- ▶ Eggs in their shells will explode if cooked with microwave power, even after taking them out of the oven. They can only be cooked in their shells using the Steam cooking  function or in an appropriate Automatic programme. Hard-boiled eggs must not be reheated with microwave power either as they too will explode, even after taking them out of the oven.
- ▶ Food with a thick skin or peel, such as tomatoes, sausage, potatoes and eggplants can burst when heated or cooked. Pierce or score the skin of these types of food several times to allow steam to escape.
- ▶ Do not use the Microwave  function to heat up cushions or pads filled with cherry kernels, wheat grains, lavender or gel, such as those used in aromatherapy. These pads can ignite when heated even after they have been removed from the oven.
- ▶ To avoid fuelling any flames, do not open the oven door if there is smoke inside the steam oven. Interrupt the programme by switching the steam oven off and disconnect it from the mains electricity supply. Do not open the door until the smoke has dispersed.
- ▶ Crockery and lids with hollow handles or knobs can collect moisture in the hollow spaces. When the moisture evaporates, pressure can build up and the item can explode. If the hollow recess is sufficiently ventilated, the item can be used. Do not use crockery with hollow knobs or handles when using the Microwave  function.

## Warning and Safety instructions

---



▶ Non-microwave safe plastic dishes can sustain damage or damage the steam oven if used with the Microwave  function and microwave functions.

Do not use any containers or cutlery made from or containing metal, aluminium foil, lead crystal glassware, temperature-sensitive plastics, wooden utensils or cutlery, metal clips or plastic or paper covered wire ties. Do not use bowls with milled rims, or plastic pots with the foil lid only partially removed (see “Microwave operation - Suitable containers for microwave use”).

▶ Fire hazard due to containers made of flammable materials. Plastic disposable containers must meet the requirements specified for crockery in “Microwave operation - Suitable containers for microwave use”.

Do not leave the steam oven unattended when heating or cooking food in disposable containers made of plastic, paper or other inflammable materials.

▶ Heat-retaining bags usually contain a thin layer of aluminium foil that reflects microwave radiation. Because of this, the paper surrounding the aluminium foil can become so hot that it combusts. Do not use heat-retaining packaging, such as bags for grilled chicken, for warming food with functions that use microwave power.

▶ If the steam oven is used without food or the food is loaded incorrectly when using the Microwave  function or functions that use microwave power, the steam oven can become damaged. Do not use the Microwave  function or functions that use microwave power to pre-heat crockery or to dry herbs. Never start the Microwave  function when the oven compartment is empty.

## Cleaning and care

- ▶ Risk of injury due to electric shock. The steam from a steam cleaning appliance could reach electrical components and cause a short circuit. Never use a steam cleaner for cleaning.
- ▶ Scratches on the door glass can result in the glass breaking. Do not use abrasive cleaners, hard sponges, brushes or sharp metal tools to clean the door glass.
- ▶ The shelf runners can be removed (see “Cleaning and care – Cleaning the shelf runners”). Refit the shelf runners correctly.
- ▶ The shelf runners fit into plastic bushes. Check the bushes carefully for damage. If the bushes are damaged, do not use any microwave functions until the bushes have been replaced.
- ▶ Try to avoid the interior walls being splashed with food or liquids containing salt. If it does happen, wipe these away thoroughly to avoid corrosion on the stainless steel surface.

## Accessories

- ▶ Use only genuine original Miele spare parts. If spare parts or accessories from other manufacturers are used, the warranty will be invalidated, and Miele cannot accept liability.

# Caring for the environment

---

## Disposal of the packing material

The transport and protective packaging has been selected from materials which are environmentally friendly for disposal, and can normally be recycled.

Recycling the packaging reduces the use of raw materials in the manufacturing process and also reduces the amount of waste in landfill sites. Ensure that any plastic wrappings, bags etc. are disposed of safely and kept out of the reach of babies and young children. Danger of suffocation.

## Disposing of your old appliance

Electrical and electronic appliances often contain valuable materials. They also contain specific materials, compounds and components, which were essential for their correct function and safety. These could be hazardous to human health and to the environment if disposed of with your domestic waste or if handled incorrectly. Please do not, therefore, dispose of your old appliance with your household waste.



Please dispose of it at your local community waste collection / recycling centre for electrical and electronic appliances. You are also responsible for deleting any personal data that may be stored on the appliance prior to disposal. Please ensure that your old appliance poses no risk to children while being stored prior to disposal.

## Steam oven

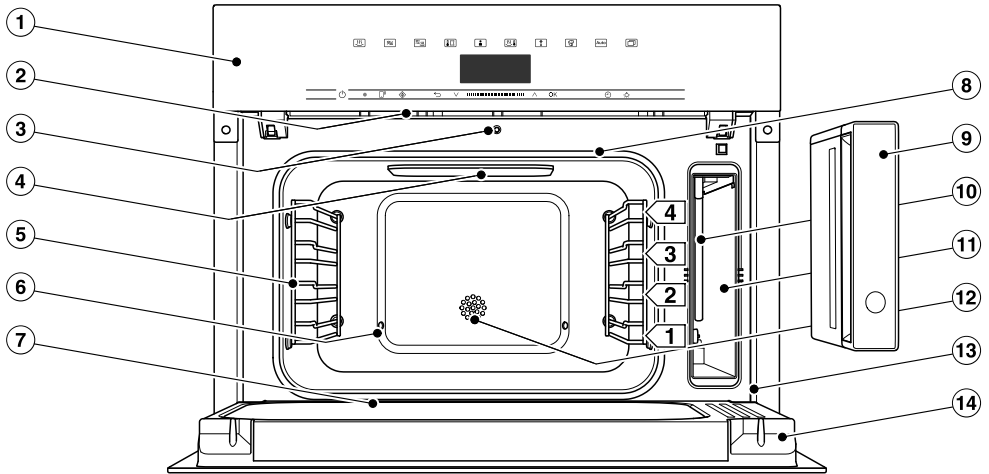

- ① Control panel
- ② Ventilation outlet
- ③ Automatic door release for steam reduction
- ④ LED oven interior lighting
- ⑤ Shelf runners with 4 shelf levels
- ⑥ Steam outlet
- ⑦ Drip channel
- ⑧ Door seal
- ⑨ Water container with removable spill guard
- ⑩ Suction tube
- ⑪ Compartment for water container
- ⑫ Temperature sensor
- ⑬ Front frame with data plate
- ⑭ Door

## Overview

---

A list of the models described in these operating and installation instructions can be found on the back page.

### Data plate

The data plate located on the front frame of the oven is visible when the door is open.

The data plate states the model number, the serial number as well as connection data (voltage, frequency and maximum rated load).

Have this information available if you need to contact Miele so that any issues can be rectified as quickly as possible.

### Accessories supplied

The accessories supplied with your appliance, as well as a range of optional ones, are available to order from Miele (see “Optional accessories”).

#### DMGS 1/1-30L



1 glass tray

The glass tray is suitable for use with all cooking functions.

Use the glass tray to catch dripping liquid when cooking with steam.

In the Microwave  function, **always** use the glass tray as a surface to place containers on.

375 x 394 x 30 mm (WxDxH)

The maximum load for the glass tray is 8 kg.

The glass tray can be damaged by large temperature fluctuations. Do not place the hot glass tray on a cold surface, such as a tiled or granite worktop. Use a suitable mat or pot rest.

The cooking containers provided and the rack are **not** suitable for use in the Microwave  function.

## DGG 1/2-40L

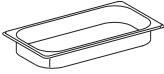

1 solid cooking container  
Gross capacity 2.2 litres /  
Useable capacity 1.6 litres  
375 x 197 x 40 mm (W x D x H)

## DGGL 1/2-40L

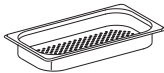

2 perforated cooking containers  
Gross capacity 2.2 litres /  
Useable capacity 1.6 litres  
375 x 197 x 40 mm (W x D x H)

## DMSR 1/1L



1 rack for placing your own cooking containers on

## Descaling tablets

For descaling the appliance.

## Miele steam oven cookbook

A selection of the best recipes from the Miele test kitchen.

## Miele cooking and reheating cookbook

A selection of the best recipes from the Miele test kitchen.

# Controls

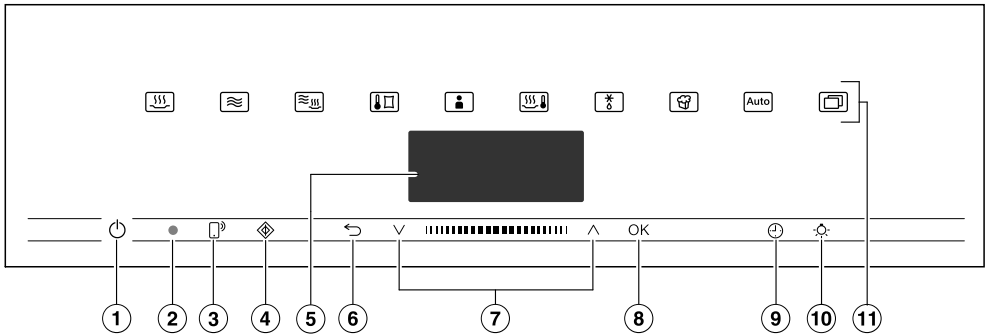

- ① Recessed On/Off  $\text{\textcircled{I}}$  sensor  
For switching the steam oven on and off
- ② Optical interface  
(for Miele service technicians only)
- ③  $\text{\textcircled{P}}$  sensor  
For controlling the steam oven via your mobile device
- ④  $\text{\textcircled{D}}$  sensor  
For starting the Quick MW function
- ⑤ Display  
For displaying the time of day and information on operation
- ⑥  $\text{\textcircled{L}}$  sensor  
For going back a step and for changing menu options during a cooking programme
- ⑦ Navigation area with  $\wedge$  and  $\vee$  arrow sensors  
For scrolling through lists and for changing values
- ⑧ OK sensor  
For calling up functions and saving settings
- ⑨  $\text{\textcircled{R}}$  sensor  
For setting a minute minder, the cooking duration or the start or finish time for the cooking programme
- ⑩  $\text{\textcircled{L}}$  sensor  
For switching the oven interior lighting on and off
- ⑪ Sensor controls  
For selecting functions, Automatic programmes and settings

## On/Off sensor

The On/Off ① sensor is recessed and reacts to touch.

Use this sensor to switch the steam oven on and off.

## Display

The display is used for showing the time of day or information about functions, temperatures, cooking durations, Automatic programmes and settings.

After switching the steam oven on with the On/Off ① sensor, Select function will appear in the main menu.

## Sensor controls

The sensors react to touch. Every touch on the sensors is confirmed by a keypad tone. This keypad tone can be switched off by selecting the Volume | Keypad tone | Off setting.





If you want the sensor controls to respond even when the steam oven is switched off, select the Display | QuickTouch | On setting.



## Sensor controls above the display

For information on the oven functions and further functions, see “Main and sub-menus”, “Settings”, “Automatic programmes” and “Other applications”.

# Controls





## Sensor controls under the display

Sensor	Function
	<p>If you want to control the steam oven from your mobile device, you must have the Miele@home system, switch on the Remote control setting and touch this sensor. The sensor then lights up orange and the MobileStart function is available.</p> <p>As long as this sensor is illuminated, you can control the steam oven via your mobile device (see “Settings – Miele@home”).</p>
	<p>Use this sensor to start the Quick MW function. The cooking programme runs with the maximum power level (1000 W) and a cooking duration of 1 minute (see “Quick MW”). Touching the sensor control repeatedly increases the cooking duration in increments.</p> <p>This function can only be used when no other cooking programmes are in use.</p>
	<p>Depending on which menu you are in, this sensor control will take you back a level or back to the main menu.</p> <p>If a cooking programme is in progress at the same time, use this sensor control to change values and settings such as the temperature or cooking duration for the programme, or to cancel the programme.</p>
	<p>In the navigation area, use the arrow sensors or the area between them to scroll up and down in the selection lists. The menu options will be highlighted one after the other as you scroll through them. The desired menu option must be highlighted before you can select it.</p> <p>You can change the values or settings that are highlighted by using the arrow sensors or the area between them.</p>

Sensor	Function
OK	<p>Functions highlighted in the display can be selected by touching the OK sensor. The selected function can then be changed.</p> <p>Confirm with OK to save changes.</p> <p>If information appears in the display, select OK to confirm the message.</p>
	<p>If no cooking programme is in progress, you can use this sensor to set a minute minder (e.g. when boiling eggs on the cooktop) at any point.</p> <p>While a cooking programme is in progress, you can set a minute minder, the cooking duration and a start or finish time for the programme.</p>
	<p>Select this sensor to switch the oven interior lighting on and off.</p> <p>Depending on the setting selected, the oven interior lighting switches off after 15 seconds or remains constantly switched on or off.</p>

## Symbols

The following symbols may appear in the display:

Symbol	Meaning
	This symbol indicates that there is additional information and advice about using the appliance. Select OK to confirm the information.
	Minute minder
	A tick indicates the option which is currently selected.
	Some settings, e.g. display brightness and signal tone volume, are selected using a segment bar.
	The system lock prevents the steam oven being switched on by mistake (see “Settings – Safety”).

# Operating principles

---

Use the  $\wedge$  and  $\vee$  arrow sensors or the **|||||** area between them in the navigation area to operate the steam oven.

The *OK* sensor lights up orange as soon as a value, setting or prompt needs to be confirmed.

## Selecting a menu option

- Touch the  $\wedge$  or  $\vee$  arrow sensor or swipe to the right or left in the **|||||** area until the desired menu option is highlighted.

**Useful tip:** If you press and hold the arrow sensor, the list continues scrolling automatically until you release the arrow sensor.

- Confirm your selection with *OK*.

## Changing a setting in a list

- Touch the  $\wedge$  or  $\vee$  arrow sensor or swipe to the right or left in the **|||||** area until you reach the desired value or the desired setting is highlighted.

**Useful tip:** A  $\checkmark$  tick will appear beside the current setting.

- Confirm with *OK*.

The setting is now saved. This will take you back to the previous menu.

## Changing the setting with a segment bar

Some settings are represented by a **■■■■■□□□** bar with seven segments. If all of the segments are illuminated, the maximum value is selected.

If none or only one of the segments is illuminated, the minimum value is selected or the setting is switched off altogether (e.g. volume).

- Touch the  $\wedge$  or  $\vee$  arrow sensor or swipe to the right or left in the **|||||** area until you reach the desired setting.

- Confirm your selection with *OK*.

The setting is now saved. This will take you back to the previous menu.

## Selecting a function

The sensor controls for the functions are located above the display (see “Operation” and “Settings”).

- Touch the sensor for the desired function.

The sensor on the control panel will light up orange.

- Under Other , scroll through the lists until the desired menu option is highlighted.
- Set the values for the cooking programme.
- Confirm with *OK*.

## Changing the function

You can change to another function during a cooking programme.

The sensor for the previously selected function lights up orange.

- Touch the sensor for the new function.
- Select *Change function? | Yes* and confirm with *OK*, if required.

The new function appears in the display with its corresponding recommended values.

The sensor for the new function lights up orange.

Under Other , scroll through the lists until you reach the desired menu option.

## Entering numbers

Numbers that can be changed are highlighted.

- Touch the  $\wedge$  or  $\vee$  arrow sensor or swipe to the right or left in the  area until the desired number is highlighted.

**Useful tip:** If you press and hold an arrow sensor, the numbers continue scrolling automatically until you release the arrow sensor.

- Confirm with *OK*.

The changed number is now saved. This will take you back to the previous menu.

# Operating principles

---

## Entering letters

Letters are entered via the navigation area. It is best to select short, memorable names.

- Touch the  $\wedge$  or  $\vee$  arrow sensor or swipe to the right or left in the **||||** area until the desired character is highlighted.

The character you have selected will appear in the top line of the display.

**Useful tip:** A maximum of 10 characters can be used.

You can delete the characters one at a time with  $\leftarrow$ .

- Select further characters.
- Once you have entered the name, select  $\checkmark$ .
- Confirm with *OK*.

The name is now saved.

## Activating MobileStart

- Select the  sensor to activate MobileStart.

The  sensor lights up. You can operate your steam oven remotely with the Miele@mobile App.

Directly operating the steam oven via the touch display takes priority over operating it via the remote control function on the App.

You can use MobileStart as long as the  sensor is lit up.

## Steam cooking function

### Water container

The maximum filling volume is 1.5 litres and the minimum is 0.5 litre. There are markings on the water container. The upper marking must never be exceeded.

Water consumption depends on the type of food and the cooking duration. The water may need to be topped up during cooking. Water consumption is increased if the door is opened during cooking.

The water container is removed using a push/pull system: push gently on the water container to remove it.

At the end of a cooking programme, hot water left in the steam generator is pumped back into the water container. The water container must be emptied after each use involving steam.

### Temperature

Some functions are allocated with a recommended temperature. The recommended temperature can be altered within the given range for an individual cooking programme or programme stage, or for every time that programme is used. You can alter the recommended temperature in 5 °C increments, or 1 °C increments in sous-vide cooking (see “Settings – Recommended temperatures”).

### Duration

You can set the cooking duration from 1 minute (00:01) to 10 hours (10:00). If the cooking duration exceeds 59 minutes, you have to enter it in hours and minutes. Example: Cooking duration 80 minutes = 1:20.

During steam cooking, the cooking duration does not begin until the set temperature is reached.

### Noises

You will hear a pumping sound when the appliance is switched on, during use and after switching it off. This is the sound of water being pumped through the system and is quite normal.

When the steam oven is in use, you will hear a fan noise.

# Description of the functions

---

## Heating-up phase

During the heating-up phase the display will show Heating up and the temperature in the oven compartment as it rises.

The duration of the heating-up phase with steam cooking will depend on the quantity and temperature of the food. In general, the heating-up phase will take approx. 7 minutes. It will be longer if you are cooking refrigerated or frozen food. The heating-up phase may also take longer when cooking at lower temperatures and when cooking with the Sous-vide  function.

## Cooking phase

The cooking phase begins when the set temperature is reached. During the cooking phase, the duration remaining will be shown in the display.

## Steam reduction

If you are cooking at a temperature above approx. 80 °C, the steam oven door will automatically open a little shortly before the end of the cooking duration to allow some of the steam to escape. Steam reduction appears in the display. The door will then close automatically.

Steam reduction can be switched off (see “Settings - Steam reduction”). When steam reduction is switched off, a large amount of steam will escape when the door is opened.

## Microwave power

### How it works

The steam oven contains a magnetron that converts electrical energy into electromagnetic waves (microwaves). These microwaves are distributed evenly throughout the oven compartment and are reflected off the metal appliance walls.

The microwaves penetrate the food from all sides. Food consists of many molecules. When subjected to microwave energy, these molecules (particularly the water molecules) start to oscillate. This heats the food from the outside to the inside. The more water a food contains, the faster it is heated or cooked.

### Advantages of the microwave oven

- Food can generally be cooked with little or no liquid or cooking oil.
- The times for defrosting, reheating or cooking are shorter than with a cooktop or oven.



## Suitable crockery

In order for microwaves to reach the food, they must be able to penetrate the crockery being used. Microwaves can pass through porcelain, glass, cardboard and plastics, but not metal. Therefore, do not use metal containers or crockery that contains metal. Metal reflects the microwaves which can create sparks and the microwaves are not absorbed by the metal.

 Risk of injury from increased pressure in sealed containers or bottles.

Pressure can build up when reheating food or drinks in sealed containers, jars or bottles, which can cause them to explode.

Never cook or reheat solid or liquid food in sealed containers or bottles. Open containers beforehand. In the case of baby bottles, the screw top and teat must be removed.

 Fire hazard due to using unsuitable crockery in the Microwave  function.

Non-microwave safe dishes used in microwave mode can suffer damage or cause damage to the steam oven. Only use microwave safe crockery in the Microwave  function.

The material and shape of containers used affect cooking results and times. Heat distribution is more even in round and oval shaped flat containers than in rectangular containers, providing better results.

# Description of the functions

## Suitable containers

 Fire hazard due to inflammable materials.

Disposable containers made out of plastic, paper or other inflammable materials can ignite, causing damage to the steam oven.

Do not leave the steam oven unattended when reheating or cooking food in disposable containers made of plastic, paper or other inflammable materials.

You can use the following crockery and material:

- Heat-resistant glass and ceramic glass  
Exception: crystal glass as it contains lead and may crack.
- Porcelain
  - Without metallic decoration  
Metallic decoration (e.g. gold rims or cobalt blue) can cause sparking.
  - Without hollow knobs and handles  
Moisture can gather in the hollow knobs and handles. When the moisture evaporates, pressure can build up and the item can explode.
- Unpainted stoneware and stoneware with underglaze paints

 Risk of injury caused by hot crockery.

Earthenware can get very hot and may crack.

Wear oven gloves when using stoneware.

- Plastic containers and plastic disposable containers with the Microwave  function

**Useful tip:** To protect the environment, avoid the use of disposable containers.

Plastic dishes and bags that are not heat-resistant may deform and fuse with the food inside.

Only use plastic containers or bags that are heat-resistant. The plastic containers and bags must be able to withstand temperatures of at least 110 °C.

- Microwave safe plastic containers  
Special plastic containers designed for use in microwave ovens are available from retail outlets.
- Styrofoam containers  
For briefly heating food.
- Plastic boiling bags  
For cooking and reheating. They should be pierced beforehand. The holes allow the steam to escape. This prevents a build-up of pressure from forming and the bag from bursting. There are also special bags available for steam cooking which do not need to be pierced. Please follow the instructions given on the packet.
- Roasting bags and tubes  
Please follow the manufacturer's instructions.

# Description of the functions

 Fire hazard due to metal parts.

Metal parts such as metal clips or plastic and paper ties that have wire running through them can heat inflammable materials until they burn. Do not use metal clips, or plastic and paper ties containing wire.

- The **rack** and **cooking containers** supplied are **only suitable** for cooking programmes in the Rapid steam cooking  function and in functions that do not use microwave power.
- Aluminium foil trays without lids for defrosting and reheating ready meals. The food is only heated from the top. If you remove the food from the aluminium foil container and transfer it to crockery suitable for use in a microwave oven, the heat distribution will generally be more even.

Using aluminium foil trays and aluminium foil can cause crackling and sparks.

Place aluminium foil trays on the glass tray.

Aluminium foil and aluminium foil trays must not touch the oven compartment walls and must remain at least 2 cm from the walls at all times.



- Metal meat skewers or clamps  
The size of the cut of meat must be much larger than the metal skewers and clamps.

## Unsuitable containers

Crockery and lids with hollow handles or knobs can collect moisture in the hollow spaces. When the moisture evaporates, pressure can build up and the item can explode. If the hollow recess is sufficiently ventilated, the item can be used.

Do not use crockery with hollow knobs or handles for cooking.

Do **not** use the following crockery and material:

- Metal racks (including the supplied rack) are **not** suitable for use with the Microwave  function.
- Containers made from metal and stainless steel (including the cooking containers supplied) are **not** suitable for use with the Microwave  function.
- Aluminium foil  
Exception: for even defrosting, reheating or cooking unevenly shaped cuts of meat, e.g. poultry, small pieces of aluminium foil may be used to cover thin parts for the last few minutes of the programme.
- Metal clips, plastic or paper ties containing wire
- Plastic containers where the aluminium lid has not been completely removed
- Crystal glass
- Cutlery and crockery with metallic decoration (e.g. gold rims, cobalt blue)

## Description of the functions

---

- Crockery with hollow handles
- Plasticware made of melamine  
Melamine absorbs microwave energy and gets hot.  
When purchasing plasticware, make sure that it is suitable for use in a microwave oven.
- Non-heat-resistant plastic containers and bags
- Wooden dishes  
Water contained in wood evaporates during the cooking programme. This causes the wood to dry and crack.

### Placing a dish in the oven

- Place the glass tray on shelf level 1.
- The dish containing the food should be placed in the middle of the glass tray.

Placing the food directly on the floor of the oven would give unsatisfactory and uneven results as the microwaves would not be able to reach the food from below.

### Cover

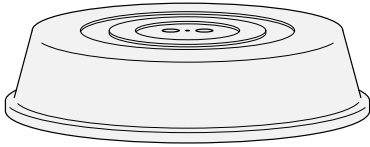

**Useful tip:** Covers are available from retail outlets.

- A cover prevents too much steam escaping, especially when cooking foods which need longer to cook.
  - It speeds up the heating process of the food.
  - It prevents food from drying out.
  - It helps keep the oven interior clean.
- Use a glass or plastic cover suitable for microwave use for cooking programmes with the Microwave  function.

Alternatively, use a cling film suitable for use in a microwave oven. Heat can cause normal cling film to distort and fuse with the food.

The cover should not form a seal with the container. If the container has a narrow diameter, the steam may not be able to escape. The cover could get too hot and start to melt.

Use containers with a sufficiently large diameter.

- Do **not** use a cover for reheating the following types of food:
  - Food coated in breadcrumbs
  - Food that needs to be heated or cooked using the Rapid steam cooking  function

# Description of the functions

---

## Glass tray

Functions/Applications involving steam:  
When using perforated containers, place the glass tray on shelf level 1. This collects any drops of liquid and allows it to be removed easily.

The condensate cannot evaporate properly if the glass tray is on the floor of the steam oven.

Place the glass tray on shelf level 1.

Microwave  function:

**Always** use the glass tray on shelf level 1 as a surface to place containers on.

## Oven interior lighting

For energy saving reasons, the oven interior lighting has been set at the factory to go out after the programme has begun.

If you want the lighting to remain on during cooking, the relevant setting needs to be changed (see “Settings - Lighting”).

If the door is left open at the end of a cooking programme, the oven lighting will switch off automatically after 5 minutes.

The lighting can be switched on for 15 seconds by pressing the  button on the control panel.

# Before using for the first time

## Miele@home

Your steam oven is equipped with an integrated Wi-Fi module.

In order to use it, you need:

- a Wi-Fi network
- the Miele@mobile App
- a Miele user account. The user account can be created via the Miele@mobile App.

The Miele@mobile App will guide you as you connect your steam oven to your home Wi-Fi network.

Once your steam oven is connected to your Wi-Fi network, you can use the App for a number of actions, including the following:

- Call up information on the operating status of your steam oven
- Retrieve information on cooking processes that are in progress
- End cooking programmes that are in progress

Connecting your steam oven to your Wi-Fi network will increase energy consumption, even when the steam oven is switched off.

Make sure that the signal of your Wi-Fi network is sufficiently strong in the place where your steam oven is installed.

## Availability of the Wi-Fi connection

The Wi-Fi connection shares a frequency range with other appliances (including microwave ovens and remote control toys). This may result in sporadic or even complete connection failures. Therefore, a constant availability of featured functions cannot be guaranteed.

## Miele@home availability

The ability to use the Miele@mobile App depends on the availability of the Miele@home service in your country.

The Miele@home service is not available in every country.

For information about availability, please visit [www.miele.com](http://www.miele.com).

## Miele@mobile App

You can download the Miele@mobile App from the Apple App Store® or the Google Play Store™ free of charge (only functional in selected countries).



# Before using for the first time

---

## Standard settings

The following settings must be made before starting up for the first time. You can change these settings again at a later time (see “Settings”).

 Risk of injury caused by hot surfaces.

The steam oven gets hot during operation.

For safety reasons, the steam oven may only be used when it has been fully installed.

The steam oven will switch on automatically when it is connected to the electricity supply.

## Setting the language

- Select the language you want.
- Confirm with *OK*.

If you have accidentally selected a language that you don't understand, proceed as described in “Settings – Language ”.

## Setting the country

- Select the country you want.
- Confirm with *OK*.

## Setting up Miele@home

Set up Miele@home appears in the display.

- To set up Miele@home immediately, select *Continue* and confirm with *OK*.
- To set it up at a later date, select *Skip* and confirm with *OK*.  
See “Settings – Miele@home” for information on setting up at a later date.
- To set up Miele@home immediately, select the desired connection method.

You will then be guided by the display and the Miele@mobile App.

## Setting the date

- Set the year, then the month, and finally the day.
- Confirm with *OK*.

## Setting the time of day

- Set the time of day in hours and minutes.
- Confirm with *OK*.

# Before using for the first time

## Setting the water hardness level

Contact your local water supplier to find out your local water hardness range if necessary.

See the “Settings - Water hardness” for more information.

- Set the water hardness level for your area.
- Confirm with *OK*.

## Completing the commissioning process

- Follow any further instructions in the display.

The appliance is now ready for use.

## Cleaning for the first time

- Remove any protective foil and stickers, except the data plate, from the oven and accessories.

The appliance has undergone a function test in the factory. Residual water from this testing may have trickled back into the cabinet during transportation.

## Cleaning the water container

- Remove the water container.
- Remove the spill guard.
- Rinse the water container by hand.

## Cleaning the accessories/oven compartment

- Take all accessories out of the oven compartment.
- Wash the accessories in a mild solution of washing-up liquid and hot water or in the dishwasher.

The interior of the steam oven has been treated at the factory with a conditioning agent.

- To remove this, clean the oven interior with a mild solution of washing-up liquid and warm water applied with a soft sponge, and then dry thoroughly with a soft cloth.

## Before using for the first time

---

### Setting the correct boiling point for water

Before cooking food for the first time, you must adjust the boiling temperature of the water, which varies depending on the altitude of where the steam oven is located. This procedure also flushes out the waterways.

This procedure **must** be carried out to ensure efficient functioning of your appliance.

Distilled or carbonated water or other liquids could damage the steam oven.





**Only use cold, fresh tap water** (below 20 °C).

- Remove the water container and fill it up to the maximum marker.
- Push the water container into the appliance.
- Run the steam oven for 15 minutes using the Steam cooking  function (100 °C). Proceed as described in “Operation”.

### Setting the correct boiling point for water following a house move

If you move house, the boiling point for the water in the steam oven will need to be reset for the new altitude if this differs from the old one by 300 m or more. To do this, descale the appliance (see “Cleaning and care – Descaling the steam oven”).

## Settings overview

Menu option	Available settings
Language 	...   deutsch   english   ... Country
Time	Show On*   Off   Night dimming Clock format 12 h   24 h* Set
Date	
Lighting	On On for 15 seconds* Off
Display	Brightness  * QuickTouch On   Off*
Volume	Buzzer tones Melodies  * Solo tone  * Keypad tone  * Welcome melody On*   Off
Units	Weight g*   lb/oz   lb Temperature °C*   °F
Quick MW	Power level Duration
Popcorn	Duration
Keeping warm	Steam cooking On   Off* Microwave On   Off*
Steam reduction	On* Off



\* Factory settings

# Settings

Menu option	Available settings
Recommended temperatures	
Recommended power levels	
Water hardness	1° dH   ...   15° dH*   ...   70° dH
Safety	Sensor lock On   Off* System lock  On   Off*
Miele@home	Activate   Deactivate Connection status Set up again Reset Set up
Remote control	On* Off
Remote update	On* Off
Software version	
Showroom programme	Demo mode On   Off*
Factory default	Appliance settings User programmes Rec. power levels Recommended temps

\* Factory settings

## Opening the “Settings” menu

In the Other  | Settings  menu, you can personalise your steam oven by adapting the factory default settings to suit your requirements.

- Select Other .
- Select Settings .
- Select the desired setting.



You can check settings or change them.

Settings cannot be altered while a cooking programme is in progress.

## Language

You can set the language and the country.

After selecting and confirming your choice, the language you have selected will appear in the display.

**Useful tip:** If you have selected the wrong language by mistake, select the  sensor. Follow the  symbol to get back to the Language  sub-menu.

## Time

### Show

Select how you want the time of day to appear in the display when the steam oven is switched off:

- On  
The time is always visible in the display.  
If you also select the Display | QuickTouch | On setting, all sensors react to touch as normal.  
If you also select the Display | QuickTouch | Off setting, the steam oven has to be switched on before it can be used.
- Off  
The display is dark to save energy.  
The steam oven has to be switched on before you can use it.
- Night dimming  
To save energy, the time is only visible in the display between 5:00 am and 11:00 pm. The display remains dark at all other times.

# Settings

---

## Clock format

The time of day can be displayed in the 24 or 12-hour format (24 h or 12 h).

### Set

Set the hours and then the minutes.



If there is a power cut, the current time of day will reappear once power has been restored. The time of day is saved for approx. 150 hours.

If the steam oven has been connected to a Wi-Fi network and signed into the Miele@mobile App, the time will be synchronised based on the country setting in the Miele@mobile App.

## Date

Set the date.



## Lighting

- On  
The oven interior lighting is switched on during the entire cooking period.
- On for 15 seconds  
The oven interior lighting switches off 15 seconds after a cooking programme has begun. Press the  sensor to switch the oven interior lighting on again for 15 seconds.
- Off  
The oven interior lighting is switched off. Press the  sensor to switch on the oven interior lighting for 15 seconds.

## Display

### Brightness

The display brightness is represented by a segment bar.

-   
Maximum brightness
-   
Minimum brightness

### QuickTouch

Select how the sensors should respond when the steam oven is switched off:

- On  
If you have also selected the Time | Show | On or Night dimming setting, the sensors will also respond when the steam oven is switched off.
- Off  
Independently of the Time | Show setting, the sensors only respond when the steam oven is switched on, as well as for a certain amount of time after switching it off.

## Volume

### Buzzer tones

If buzzers are switched on, a buzzer will sound when the set temperature is reached and at the end of a set time.

### Melodies

At the end of a process, a melody will sound several times at intervals.

The volume of the melody is represented by a segment bar.

– ■■■■■■■■  
Maximum volume

– □□□□□□  
Melody is switched off

### Solo tone

At the end of a process, a continuous tone will sound for a period of time.

The pitch of this continuous tone is represented by a segment bar.

– ■■■■■■■■■■■■■■■■■■■■  
Maximum pitch

– □□□□□□□□□□□□□□  
Minimum pitch

## Keypad tone

The volume of the tone that sounds each time you touch a sensor is represented by a segment bar.

– ■■■■■■■■  
Maximum volume

– □□□□□□  
Keypad tone is switched off

## Welcome melody

The melody that sounds when you touch the On/Off (ⓘ) sensor can be switched on or off.

## Units

### Weight

For Automatic programmes, you can set the weight of food in grams (g), pounds/ounces (lb/oz) or pounds (lb).

### Temperature

You can set the temperature in degrees Celsius (°C) or degrees Fahrenheit (°F).

# Settings

---

## Quick MW

The maximum microwave power level of 1000 W and the maximum cooking duration of 1 minute are preset for starting the microwave function immediately.

- Power level  
The following microwave power levels can be selected: 80 W, 150 W, 300 W, 450 W, 600 W, 850 W or 1000 W.
- Duration  
The maximum cooking duration that can be set depends on the microwave power level selected:  
80–300 W: maximum 10 minutes  
450–1000 W: maximum 5 minutes

## Popcorn

A microwave power level of 850 W and a cooking duration of 2:50 minutes is preset so that you can start cooking a bag of microwave popcorn immediately. These settings match the manufacturer's instructions on most bags of microwave popcorn.

The maximum cooking duration that can be set is 4 minutes.

The microwave power level is set and cannot be modified.

## Keeping warm

Using the Keeping warm function, you can keep food warm after cooking. Food is kept warm at a preset temperature or microwave power for a maximum of 15 minutes. You can cancel the keeping warm process by opening the door or touching the sensors.

Please note that delicate food, especially fish, can continue cooking whilst being kept warm.

## Steam cooking

- On  
The Keeping warm function is switched on. If a temperature of at least 80 °C is selected, this function will switch on after approx. 5 minutes. The food is kept warm using a temperature of 70 °C.
- Off  
The Keeping warm function is switched off.

## Microwave

- On  
The Keeping warm function is switched on. When a microwave power level of at least 450 W and a cooking duration of at least 10 minutes have been selected, this function will switch on after approx. 5 minutes. The food is kept warm with a microwave power level of 150 W.
- Off  
The Keeping warm function is switched off.

## Steam reduction

- On  
If you have cooked at a temperature above approx. 80 °C, the steam oven door will automatically open a little shortly before the end of the cooking duration. This is to prevent a large amount of steam escaping when the door is opened. The door will then close automatically.
- Off  
If steam reduction is switched off, the Keeping warm function is also automatically switched off. When steam reduction is switched off, a large amount of steam will escape when the door is opened.

## Recommended temperatures

If you frequently cook with different temperatures, it makes sense to change the recommended temperatures.

After selecting this option, a list of oven functions will appear in the display.



- Select the function you want.

The recommended temperature will appear together with the range within which it can be changed.



- Change the recommended temperature.
- Confirm with *OK*.

## Recommended power levels

If you frequently cook with different power levels, it makes sense to change the recommended microwave power levels.

You can change the recommended power levels for the Microwave  function and for the Rapid steam cooking  function combining steam cooking and microwave cooking.

After selecting this option, a list of functions will appear in the display together with their recommended power levels.

- Microwave :  
80 W, 150 W, 300 W, 450 W, 600 W, 850 W, 1000 W
- Rapid steam cooking :  
80 W, 150 W, 300 W

- Select the function you want.
- Change the recommended power level.
- Confirm with *OK*.

# Settings

## Water hardness

To ensure that the steam oven works correctly and to ensure that descaling is carried out at the correct interval, it must be set to the local water hardness level. The harder the water is, the more frequently the steam oven needs to be descaled.

Contact your local water supplier to find out your local water hardness range if necessary.

If you are using bottled drinking water, e.g. mineral water, use non-carbonated water. Select settings according to the calcium content. The calcium content is given on the label of the bottle in mg/l Ca<sup>2+</sup> or ppm (mg Ca<sup>2+</sup>/l).

The degree of hardness can be set between 0.2 mmol/l (1° dH) and 12.5 mmol/l (70° dH). The hardness level is set to 2.7 mmol/l (15 °dH) at the factory.

- Set the water hardness level for your area.
- Confirm with OK.

Water hardness		Calcium content mg/l Ca <sup>2+</sup> or ppm (mg Ca <sup>2+</sup> /l)	Setting
°dH	mmol/l		
1	0.2	7	1
2	0.4	14	2
3	0.5	21	3
4	0.7	29	4
5	0.9	36	5
6	1.1	43	6
7	1.3	50	7
8	1.4	57	8
9	1.6	64	9

Water hardness		Calcium content mg/l Ca <sup>2+</sup> or ppm (mg Ca <sup>2+</sup> /l)	Setting
°dH	mmol/l		
10	1.9	71	10
11	2.0	79	11
12	2.2	86	12
13	2.3	93	13
14	2.5	100	14
15	2.7	107	15
16	2.9	114	16
17	3.1	121	17
18	3.2	129	18
19	3.4	136	19
20	3.6	143	20
21	3.8	150	21
22	4.0	157	22
23	4.1	164	23
24	4.3	171	24
25	4.5	179	25
26	4.7	186	26
27	4.9	193	27
28	5.0	200	28
29	5.2	207	29
30	5.4	214	30
31	5.6	221	31
32	5.8	229	32
33	5.9	236	33
34	6.1	243	34
35	6.3	250	35
36	6.5	257	36
37-45	6.6-8.0	258-321	37-45
46-60	8.2-10.7	322-429	46-60
61-70	10.9-12.5	430-500	61-70

## Safety

### Sensor lock

The sensor lock prevents the cooking programme being switched off by mistake or settings being changed. Apart from the On/Off ① sensor, the activated sensor lock prevents the sensors and fields in the display from working a few seconds after a programme has been started.

- On  
The sensor lock is switched on. Touch the *OK* sensor for at least 6 seconds to deactivate the sensor lock for a short period of time.
- Off  
The sensor lock is deactivated. All sensor controls react to touch as normal.

If you want to switch off the oven with the sensor lock activated, touch the On/Off ① sensor until the oven switches off.

### System lock

The system lock prevents the appliance being switched on by mistake.

The minute minder and the MobileStart function can still be used when the system lock is active.

The system lock will remain activated even after a power failure.

- On  
The system lock is switched on. Before you can use the steam oven, touch the *OK* sensor for at least 6 seconds.
- Off  
The system lock is deactivated. You can use the steam oven as normal.

# Settings

---

## Miele@home

The steam oven is a Miele@home compatible appliance. Your steam oven is fitted ex-works with a Wi-Fi communication module and is suitable for wireless communication.

There are a number of ways of connecting your steam oven to your Wi-Fi network: We recommend connecting your steam oven to your Wi-Fi network with the help of the Miele@mobile App or via WPS.

After installing the Miele@mobile App on a mobile device, you can do the following, depending on your appliance:

- Operate your appliance remotely
- Call up information on the operating status of your appliance
- Call up information on the programme sequence of your appliance
- Set up a Miele@home network with other Wi-Fi enabled Miele appliances

- Activate  
This setting is only visible if Miele@home is deactivated. The Wi-Fi function is reactivated.
- Deactivate  
This setting is only visible if Miele@home is activated. Miele@home remains set up, the Wi-Fi function is switched off.
- Connection status  
This setting is only visible if Miele@home is activated. The display shows information such as the Wi-Fi reception quality, network name and IP address.
- Set up again  
This setting is only visible if a Wi-Fi network has already been set up. Reset the network settings and immediately set up a new network connection.
- Reset  
This setting is only visible if a Wi-Fi network has already been set up. The Wi-Fi function is deactivated and the Wi-Fi network will be reset to the factory default. You must set up a new connection to the Wi-Fi network to be able to use Miele@home.
- Set up  
This setting is only visible if there is no existing Wi-Fi network. You must set up a new connection to the Wi-Fi network to be able to use Miele@home.

## Remote control

If you have installed the Miele@mobile App on your mobile device, have access to the Miele@home system and have activated the remote control function (On), you can use the MobileStart function to retrieve information on steam oven cooking programmes currently in progress or to end a programme in progress.

### Activating MobileStart

- Select the  sensor to activate MobileStart.

The  sensor lights up. You can operate your steam oven remotely with the Miele@mobile App.

Directly operating the steam oven via the touch display takes priority over operating it via the remote control function on the App.

You can use MobileStart as long as the  sensor is lit up.

## Remote update

The Remote update menu option is only displayed and can only be selected if the requirements for using Miele@home have been met (see “Before using for the first time – Miele@home” or “Settings”).

The RemoteUpdate function is used for updating the software in your steam oven. If an update is available for your steam oven, it will automatically download it. Updates will not be installed automatically. They must be initiated manually.

If you do not install an update, you can continue to use your steam oven as usual. However, Miele recommends installing updates.

### Switching on/Switching off

RemoteUpdate is switched on as standard. Available updates will be downloaded automatically and will only be installed if you initiate it.

Switch off RemoteUpdate if you do not wish any updates to be downloaded.

# Settings

---

## Running a RemoteUpdate

Information about the content and scope of an update is provided in the Miele@mobile App.

A message will appear in your steam oven display if a software update is available.

You can install the update immediately or postpone this until later. When the steam oven is switched on again, you will be reminded about the update.

Switch RemoteUpdate off if you do not wish to install updates.

The update can take several minutes.

Please note the following information about the RemoteUpdate function:

- You will only receive a message when an update is available.
- Once an update has been installed, it cannot be undone.
- Do not switch the steam oven off during the update. Otherwise, the update will be aborted and will not be installed.
- Some software updates can only be carried out by a Miele service technician.

## Software version

The software version menu option is for use by Miele service technicians. You do not need this information for domestic use.

## Showroom programme

This function enables the steam oven to be demonstrated in showrooms without heating up. Do not activate this setting for domestic use.

### Demo mode

If you have activated Demo mode, Demo mode is activated. The appliance will not heat up will appear when you switch the steam oven on.

- On  
Touch the OK sensor for at least 4 seconds to activate Demo mode.
- Off  
Touch the OK sensor for at least 4 seconds to deactivate Demo mode. You can use the steam oven as normal.

## Factory default

- Appliance settings  
Any settings that have been altered will be reset to the factory default settings.
- User programmes  
All User programmes will be deleted.
- Rec. power levels  
Microwave power levels which have been changed will be reset to the factory default settings.
- Recommended temps  
Any recommended temperatures that have been changed will be reset to the factory default settings.

## Using the Minute minder function

The  minute minder can be used to time other activities in the kitchen, e.g. boiling eggs on the cooktop.

The minute minder can also be used at the same time as a cooking programme for which the cooking duration start and finish times have been set (e.g. as a reminder to stir the food or add seasoning, etc.).

- The maximum minute minder time that can be set is 59 minutes and 59 seconds.

## Setting the minute minder

If you have selected the **Display | QuickTouch | Off** setting, you will need to switch the steam oven on before setting the minute minder. The minute minder can then be seen counting down in the display when the steam oven is switched off.

Example: You want to boil some eggs and set a minute minder time of 6 minutes and 20 seconds.

- Select the  sensor.
- Select **Minute minder** if a cooking programme is in progress at the same time.

The prompt **Set 00:00 min** will appear.

- Using the navigation area, set **06:20**.
- Confirm with **OK**.

The minute minder duration is now saved.

When the steam oven is switched off, the minute minder time will count down in the display and  will appear instead of the time of day.

If you are cooking at the same time,  and the minute minder time will appear at the bottom of the display.

If you are in a menu, the minute minder will count down in the background.

At the end of the minute minder time  will flash, the time will start counting up and a buzzer will sound.

- Select the  sensor.
- If required, confirm with **OK**.

The buzzer will stop and the symbols in the display will go out.

## Changing the time set for the minute minder

- Select the  sensor.
- Select **Minute minder** if a cooking programme is in progress at the same time.
- Select **Change**.
- Confirm with **OK**.

The minute minder time selected appears.

- Change the time set for the minute minder.
- Confirm with **OK**.

The altered minute minder time is now saved.

# Minute minder











---

## Cancelling the minute minder



- Select the 🕒 sensor.
- Select Minute minder if a cooking programme is in progress at the same time.
- Select Delete.
- Confirm with *OK*.

The minute minder is now cancelled.

## Main and sub-menus

Menu	Recommended value	Range
Oven functions		
Steam cooking 	100 °C	40–100 °C
Microwave 	1000 W	80–1000 W
Rapid steam cooking 	300 W 100 °C	80–300 W 80–100 °C
Sous-vide 	65 °C	45–90 °C
User programmes 		
Reheat 		
Steam cooking	100 °C	80–100 °C
Microwave	450 W	450–1000 W
Defrost 		
Steam cooking	60 °C	50–60 °C
Microwave	150 W	80–150 W
Popcorn 		
Automatic programmes 		
Other 		
Blanch	–	–
Bottling	90 °C	80–100 °C
Disinfect items	–	–
Prove yeast dough	–	–
Eco Steam cooking	100 °C	40–100 °C

# Main and sub-menus

Menu	Recommended value	Range
Other 		
Maintenance		
Descalc		
Soak		
Settings 		

- Switch the steam oven on.

The main menu will appear.

- If you want to cook using a steam function, fill the water container and fit it back in place.

Distilled or carbonated water or other liquids could damage the steam oven.

**Only use cold, fresh tap water** (below 20 °C).

- Place the food in the oven.
- Select the function you want.

The function will appear in the display. Based on the function you have selected, the recommended power level, recommended temperature and cooking duration will appear one after the other on the display.

- Change the recommended values for the cooking programme and set the cooking duration if required.

Using the ↶ sensor, you can change the recommended values later if needed.

- Confirm each entry with *OK*.  
Confirming the temperature starts the cooking process for functions which **do not use** microwave power.

For functions **which use** microwave power, a summary of the settings appears and *Start* is highlighted in the display.

- Use the *OK* sensor to start the cooking process for functions **which use** microwave power.

The set values appear and the cooking duration counts down in the display for all functions.

If you have set a temperature, you will see the temperature increasing. A buzzer will sound when the set temperature is reached for the first time.

The oven stops generating microwave power when you interrupt the cooking programme or open the door. You can continue the programme with the *OK* sensor.

- After cooking, select the sensor for the selected function to end the cooking programme.

 Risk of injury due to hot steam. When using a cooking programme involving steam, a lot of hot steam can escape if the door is opened. The steam can cause burns. Step back and wait until the hot steam has dissipated.

- Take the food out of the oven.
- Switch the steam oven off.

# Operation

---

## Cleaning the steam oven

 Risk of injury due to hot water.  
At the end of a steam cooking programme, hot water left in the steam generator is pumped back into the water container.  
Take care not to tip the water container when taking it out of the appliance.

- Remove the water container as required.
- Remove the spill guard and empty the water container.
- After each use, clean and dry the whole appliance as described in “Cleaning and care”.

Make sure the spill guard engages correctly when installing it.

- Leave the appliance door open until the oven interior is completely dry.

## Refilling the water

If water needs replenishing during the cooking programme, a tone will sound and the display will prompt you to refill the container with fresh water.

- Remove the water container and fill it with fresh tap water.
- Push the water container into the appliance.

The cooking programme will continue.

## Changing values and settings for a cooking programme

Depending on the function, as soon as a cooking programme is in progress, you can use the ↵ sensor to change the values or settings for this programme.

- Select the ↵ sensor.

Depending on the function, the following settings appear:



- Temperature
- Power level
- Duration

## Changing values and settings

- Select the desired value or setting and confirm with *OK*.
- Change the value or setting and confirm with *OK*.

The cooking programme will continue with the new values and settings.



## Changing the temperature



You can permanently reset the recommended temperature to suit your cooking preferences by selecting Other  | Settings  | Recommended temperatures.

- Select the  sensor.
- Select Temperature and confirm with *OK*.
- Change the target temperature via the navigation area.
- Confirm with *OK*.

The cooking programme will restart with the new target temperature.

## Changing the microwave power level

You can change the microwave power level in the Microwave  and Rapid steam cooking  functions.

Select Other  | Settings  | Recommended power levels to permanently set the recommended power level to suit your personal cooking preferences.

- Select the  sensor.
- Select Power level and confirm with *OK*.
- Change the microwave power level via the navigation area.

You can set the microwave power level to 80 W, 150 W, 300 W, 450 W, 600 W, 850 W, 1000 W, depending on the function in question.

- Confirm with *OK*.

Start will be highlighted.

- Select the *OK* sensor.

The process will restart with the new microwave power level.

# Operation

---

## Setting cooking durations



Cooking results can be adversely affected if there is a long delay between the food being placed in the oven and the start of cooking. Fresh food can change colour and even spoil.

Select as short a time as possible until the start of the cooking process.

Example: You have placed the food in the oven compartment, selected a function and the required settings such as the temperature.

By entering Duration, Finish at or Start at via the  sensor, you can automatically switch the cooking programme off or on and off.

- Duration  
Enter the required cooking duration for the food. The heating will switch off automatically once this duration has elapsed. The maximum cooking duration that can be set depends on the function that you have selected.
- Finish at  
Specify when you want the cooking programme to finish. The oven heating will switch off automatically at the time you have set.
- Start at  
This function will only appear in the menu if you have set a Duration or Finish at time. With Start at, you have to specify when you want the cooking programme to start. The oven heating will switch on automatically at the time you have set.

- Select the  sensor.
- Set the required times.
- Confirm with *OK*.
- Touch the  sensor to return to the menu of the selected function.

**Tip:** In functions involving steam, you can also adjust the cooking duration directly using the navigation area.

For cooking programmes involving steam, the cooking duration does not begin until the set temperature is reached.

If you are cooking at a temperature of approx. 80 °C or above, Steam reduction will appear in the display shortly before the end of the cooking duration and the door will automatically open a little. The door will then automatically close.

- Wait until Steam reduction goes out in the display before opening the door and removing the food from the oven.

A new cooking programme can only be started if the automatic door release is retracted into its original position. Do not push it in manually as this could damage it.

## Changing the set cooking durations

- Select the ⌚ sensor.
- Select the time you want.
- Confirm with *OK*.
- Select *Change*.

This menu option does not appear if you want to change the cooking duration for functions **which use** microwave power, as these functions always require a set cooking duration.

The time will be highlighted.

- Change the set time.
- Confirm with *OK*.
- Touch the ↶ sensor to return to the menu of the selected function.
- Use the *OK* sensor to continue the cooking programme for functions **which use** microwave power.

These settings will be deleted in the event of a power failure.

**Useful tip:** You can also change the cooking duration via the navigation area.

# Operation

---

## Deleting the set cooking durations

For a function **which uses** microwave power, you can only delete the set times for Finish at and Start at. The cooking duration must always be set.



- Select the ⌚ sensor.
- Select the time you want.
- Confirm with *OK*.
- Select Delete.
- Confirm with *OK*.
- Touch the ↩ sensor to return to the menu of the selected function.

If you delete Duration for a function which **does not use** microwave power, the set times for Finish at and Start at are also deleted.

If you delete Finish at or Start at, the cooking programme will start using the cooking duration set.

**Useful tip:** In functions involving steam, you can also clear the cooking duration using the navigation area.

## Interrupting the cooking process for functions which use microwave power

You can interrupt cooking when using the Microwave  and Rapid steam cooking  functions and pause the cooking duration.

During the cooking duration, Stop will be highlighted.

- Select the *OK* sensor.

Cooking is interrupted and the cooking duration is paused.

Start will be highlighted.

- Select the *OK* sensor.

The cooking programme resumes and the cooking duration continues to count down.

## Interrupting the cooking process for functions involving steam

In functions involving steam, opening the door will interrupt the cooking programme. The oven heating switches off. Set cooking durations will be saved.

 Risk of injury due to hot steam. A great deal of hot steam can escape when the door is opened. The steam can cause burns. Step back and wait until the hot steam has dissipated.

 Risk of injury caused by hot surfaces and food. The steam oven gets hot during operation. You could burn yourself on the oven compartment, shelf runners, accessories or the food itself. Wear oven gloves when placing food in the oven or removing it and when adjusting oven shelves etc. in a hot oven. When placing cooking containers in the oven or removing them, make sure that the hot food does not spill.

The steam oven will heat up again and the display will show the temperature in the cooking compartment as it rises. Once the set temperature has been reached, the display will show the time left as it counts down.

The cooking process will be ended early if the door is opened in the last minute of cooking time.

The cooking programme will resume when the door is closed.

When the door is closed, the pressure has to equalise, which can cause a whistling sound.

# Operation

---

## Cancelling cooking

You can cancel a cooking programme using the function sensor that lights up orange or using the ↵ sensor.

The oven compartment heating and lighting will then switch off. Any cooking durations set will be deleted.

Touch the function sensor to return to the main menu.

## Cancelling a cooking programme without a set cooking duration

- Touch the sensor for the selected function.

The main menu will appear.

- **Or:** select the ↵ sensor.
- Select *Cancel process*.
- Confirm with *OK*.

## Cancelling a cooking programme with a set cooking duration

- Touch the sensor for the selected function.

*Cancel cooking?* appears in the display.

- Select *Yes*.
- Confirm with *OK*.
- **Or:** select the ↵ sensor.
- Select *Cancel process*.
- Confirm with *OK*.
- Select *Yes*.
- Confirm with *OK*.

These functions can only be used when no other cooking programmes are in use.

Always use the glass tray.

### Quick MW

If you select the  sensor, the oven starts with a set microwave power level and cooking duration, e.g. to reheat a drink.

The maximum power level of 1000 W and a maximum duration of 1 minute are preset.

You can change the microwave power level and the cooking duration. The maximum cooking duration that can be set depends on the microwave power level selected (see “Settings – Quick MW”).

- Select the  sensor.  
Touching it repeatedly increases the cooking duration in increments.

The time left will appear in the display.

You can interrupt and resume the cooking programme at any time by touching the *OK* sensor or cancel it with the  sensor.

At the end of the cooking programme, *Finished* appears in the display and a buzzer sounds.

- Select the  sensor.

The main menu will appear.

# Quick MW and Popcorn

---

## Popcorn

If you select the  sensor, the oven starts with a set microwave power level and cooking duration.

A microwave power level of 850 W and a maximum cooking duration of 2:50 minutes are preset. These settings match the manufacturer's instructions on most bags of microwave popcorn.

The maximum cooking duration that can be set is 4 minutes. The microwave power level is set and cannot be modified (see "Settings – Popcorn").

Follow the manufacturer's instructions regarding the cooking duration on the packaging. Change the preset time if necessary.

- Select the  sensor.

The time left will appear in the display.

You can interrupt and resume the cooking programme at any time by touching the *OK* sensor or cancel it with the  sensor.

Disposable containers made out of paper or other inflammable materials can ignite, causing damage to the steam oven.

Do not leave the steam oven unattended during this programme and make sure you follow the instructions on the packaging.

At the end of the cooking programme, *Finished* appears in the display and a buzzer sounds.

- Select the  sensor.

The main menu will appear.

# General notes on steam cooking

---

This section contains general information. You will find more detailed information about particular foods and how to cook them in the other sections.

## The advantages of cooking with steam

Almost all vitamins and minerals are retained as the food is not immersed in water.

Cooking with steam also retains the true taste of the food better than conventional cooking. We therefore recommend seasoning the food after it has been cooked. Food also retains its fresh, original colour.

## Suitable containers

### Cooking containers

This steam oven is supplied with stainless steel cooking containers. Other containers, in a variety of sizes, both perforated and solid, are available as optional extras (see “Optional accessories”). This enables you to choose the most suitable container for the food you are preparing.

Where possible, it is best to use perforated cooking containers for steam cooking. The steam can reach the food from all sides and the food is cooked evenly.

### Your own containers

You can also use your own containers. However, please note the following:

- Containers must be heat-resistant to 100 °C and able to withstand steam. With plastic containers, please check with the manufacturer that they are suitable for use in a steam oven.
- Thick-sided containers made from porcelain, ceramic, or stoneware are not very suitable for using with steam. Due to their thick sides, they do not conduct heat well and as a result cooking durations will be considerably longer than those given in the charts.
- Place the cooking container on the rack or in a suitable container, and not on the oven floor.
- Ensure that there is a gap between the upper rim of the container and the top of the cooking compartment to allow sufficient steam into the container.

### Glass tray

When using perforated containers, place the glass tray on shelf level 1. This collects any drops of liquid and allows it to be removed easily.

The condensate cannot evaporate properly if the glass tray is on the floor of the steam oven.  
Place the glass tray on shelf level 1.

# General notes on steam cooking

---

## Shelf level

You can select any shelf level for the cooking containers and the rack. You can also cook on several levels at the same time. This will not alter the cooking duration.

When using more than one deep container at the same time for steam cooking, it is best to offset them on their runners and to leave at least one level free in between them.

Always insert cooking containers, the rack and the glass tray between the rails of the shelf runners so that they cannot tip.

## Frozen

The heating-up phase for frozen food is longer than for fresh food. The greater the quantity of frozen food, the longer the heating-up phase.

## Temperature

During steam cooking, the temperature does not exceed 100 °C. Almost all foods can be cooked at this temperature. Some types of food, such as berries, need to be cooked at lower temperatures to prevent them from bursting. See the relevant sections in these operating instructions for more details.

## Duration

During steam cooking, the cooking duration does not begin until the set temperature is reached.

In general, the cooking durations for cooking with steam are the same as for cooking food in a saucepan. More information about any factors which may affect the cooking duration is given in the relevant sections.

The quantity of food does not affect the cooking duration. 1 kg of potatoes will take the same time to cook as 500 g of potatoes.

## Cooking with liquid

When cooking with liquid, only fill the cooking container  $\frac{2}{3}$  full to prevent the liquid spilling when the cooking container is removed from the oven.

## Your own recipes

Food which is cooked in a pot or a pan can also be cooked in the steam oven. The cooking durations in the steam oven will be the same. Please note that food will not be brown or crisp when cooking with steam.

## Eco Steam cooking

You can use the Eco Steam cooking function to save energy during steam cooking. This function is suitable mainly for cooking fish and vegetables.

We recommend using the cooking durations and temperatures given in the chart under “Steam cooking”.

You can cook for longer if necessary.

When cooking starchy foods such as potatoes, rice and pasta, the best function to use is Steam cooking .

## Setting

Other  | Eco Steam cooking

## Notes on the cooking charts

Follow the instructions on cooking durations, temperatures and cooking notes.

### Selecting the cooking duration

The cooking durations given are guidelines only.

- We recommend selecting the shorter duration initially. You can cook for longer if necessary.

# Steam cooking

---

## Vegetables

### Fresh

Prepare fresh vegetables in the usual way, i.e. wash, clean and cut them up.

### Frozen food

Frozen vegetables do not need to be defrosted beforehand. Exception: the vegetables have been frozen together in a block.

Frozen and fresh vegetables which take the same length of time to cook can be cooked together.

If vegetables have frozen together in clumps, break these up before cooking with steam. Follow the manufacturer's instructions on the packaging regarding cooking duration.

### Cooking containers

Food such as peas or asparagus spears, which have little or no space between them, will take longer to cook because the steam has less space to work in. For an even result, it is best to use a shallow container for these types of food, and only fill it about 3 - 5 cm deep. When cooking large quantities, divide the food between 2 or 3 shallow containers rather than using one deep one.

Different types of vegetables which take the same length of time to cook can be cooked together in one cooking container.

Use solid containers for vegetables which are cooked in liquid, e.g. cabbage.

### Shelf level

When cooking vegetables with a distinctive colour (e.g. beetroot) in a perforated container at the same time as cooking other foods in other containers, place the solid tray directly underneath the perforated container to catch any drips and therefore avoid any colour transfer.

### Duration

The cooking duration depends on the size of the food and how well cooked you want it, just as it does with conventional cooking methods.

Example:

Firm potatoes, cut into quarters:  
approx. 12 minutes

Firm potatoes, cut in half:  
approx. 17 minutes

### Settings

Automatic programmes  | Vegetables  
| ... |

or

Steam cooking   
Temperature: 100 °C  
Duration: see chart

## Steam cooking

<b>Vegetables</b>	 [min.]
Artichokes	32–38
Cauliflower, whole	27–28
Cauliflower, florets	8
Beans, green	6–8
Broccoli, florets	2–4
Chantenay carrots, whole	7–8
Chantenay carrots, halved	5–6
Chantenay carrots, chopped	4
Chicory, halved	4–5
Chinese cabbage, chopped	3
Peas	2
Fennel, halved	10–12
Fennel, sliced	4–5
Kale, chopped	23–26
Firm potatoes, peeled whole halved quartered	20–25 15–20 10–15
Fairly firm potatoes, peeled whole halved quartered	23–28 18–23 14–18
Soft potatoes, peeled whole halved quartered	25–30 20–25 15–20
Kohlrabi, cut into batons	6–7
Pumpkin, diced	4–8
Corn on the cob	10–15
Silverbeet, chopped	2–3

## Steam cooking

<b>Vegetables</b>	<b>🕒 [min.]</b>
Capsicum, diced or sliced	2
New potatoes, firm	20–25
Mushrooms	2
Leeks, sliced	2–4
Leeks, halved lengthways	4–6
Romanesco, whole	22–25
Romanesco, florets	5–7
Brussels sprouts	10–12
Beetroot, whole	50–60
Red cabbage, chopped	15–20
Black salsify, whole	9–10
Celeriac, cut into batons	6–7
Asparagus, green	2–4
Asparagus, white	5–10
Carrots, chopped	6
Spinach	1–2
Spring cabbage, chopped	10–11
Celery, chopped	2–5
Turnips, chopped	6–7
White cabbage, chopped	12
Savoy cabbage, chopped	10–11
Zucchini, sliced	2–3
Sugar snap peas	2–3

🕒 Duration

## Fish

### Fresh

Prepare fresh fish in the usual way, i.e. clean, gut and fillet.

### Frozen

Fish does not need to be fully defrosted before cooking. Defrost so that the surface is sufficiently thawed to take herbs and seasoning. Depending on the thickness of the fish, 2–5 minutes should be enough.

### Preparation

Add some lemon or lime juice to fish before cooking. The citric acid helps the flesh stay firm.

It is not necessary to season fish when cooking with steam as this method retains the minerals which give the fish its unique flavour.

### Cooking containers

If using a perforated container, grease it first or line it with baking paper.

### Shelf level

When cooking fish in a perforated container at the same time as cooking other types of food in other containers, place the container with the fish directly above the glass or collecting tray (depending on the model) to catch any liquid and so avoid any transfer of flavours to other food.

### Temperature

#### 85 °C – 90 °C

For gently cooking delicate types of fish, such as flounder.

#### 100 °C

For cooking firmer types of fish, e.g. salmon.  
Also for cooking fish in sauce or stock.

### Duration

The cooking duration depends on the thickness and the texture of the fish, and not on the weight. The thicker the fish, the longer the cooking duration. A 3 cm thick piece of fish weighing 500 g will take longer to cook than a 2 cm thick piece of fish weighing 500 g.

The longer fish cooks, the firmer its flesh will become. Use the cooking durations given in the chart. If you find that the fish is not cooked sufficiently, only cook it for a few minutes more.

When cooking fish in sauce or stock, we recommend that you increase the cooking duration quoted by a few minutes.

# Steam cooking

---

## Useful tips

- Adding herbs and spices, such as dill, will help bring out the full flavour of the fish.
- Cook large fish in the swimming position. To help maintain the structure of the fish, place a small cup or similar upside down in the cooking container. Arrange the fish bellyside down over the cup.
- You can use any fish scraps, e.g. fish heads, bones, tails etc. to make a **fish stock**. Place the fish scraps together with some mixed vegetables in a solid cooking container and add cold water. Cook at 100 °C for 60 to 90 minutes. The longer the cooking duration, the stronger the stock.
- Preparing fish **au bleu** is a method involving cooking the fish in water with vinegar, at different proportions depending on the recipe. It is important not to damage the skin of the fish. This method is suitable for cooking trout, tench, eel and salmon.

## Settings

Automatic programmes  | Fish | ... |

or

Steam cooking 

Temperature: see chart

Duration: see chart

## Steam cooking

Fish	🌡️ [°C]	🕒 [min.]
Eel	100	5–7
Perch fillet	100	3–5
Bream/Snapper fillet	85	3–5
Trout, 250 g	90	8–12
Halibut/Trumpeter fillet	85	4–6
Blue eye trevalla/Ling fillet	100	6
Salmon fillet	100	4–8
Salmon steak	100	8–10
Australian salmon	90	8–10
Basa fillet	85	3
Rosefish fillet	100	6–8
Jackass morwong/Terakihi fillet	100	4–6
Flounder fillet	85	4–5
Stargazer/Monkfish fillet	85	6–8
Sole fillet	85	3
Turbot fillet	85	5–8
Tuna fillet	85	4–8
Pikeperch fillet	85	4

🌡️ Temperature, 🕒 duration

# Steam cooking

---

## Meat

### Fresh

Prepare the meat in the usual way.

### Frozen

Meat should be thoroughly defrosted before cooking in the steam oven (see “Special applications - Defrosting with steam”).

### Preparation

Meat which needs to be seared before being cooked, e.g. stewing steak, should be seared in a pan on the cooktop.

### Duration

The cooking duration depends on the thickness and the texture of the meat, and not on the weight. The thicker the piece of meat, the longer the cooking duration. A piece of meat weighing 500 g which is 10 cm thick will take longer to cook than a piece of meat weighing 500 g which is 5 cm thick.

## Useful tips

- To retain the **flavourings**, use a perforated cooking container. Place an unperforated cooking container underneath in order to collect the concentrate. You can use the concentrate to enhance your sauces or freeze it for later use.
- Boiling chicken, back or top rib and meat bones can be used to make **stock**. Place the meat together with the bones and some mixed vegetables in a cooking container and add cold water. The longer the cooking duration, the stronger the stock.

## Settings

Automatic programmes  | Meat | ... |

or

Steam cooking 

Temperature: 100 °C

Duration: see chart

## Steam cooking

<b>Meat</b>	<b>🕒 [min.]</b>
Beef shin, covered with water	110–120
Pork knuckle	135–140
Chicken breast fillet	8–10
Knuckle	105–115
Beef soup bones	110–120
Veal for stewing	3–4
Gammon steaks	6–8
Lamb stew	12–16
Turkey roulade	12–15
Turkey schnitzel	4–6
Rib of beef, covered with water	130–140
Beef stew	105–115
Boiling chicken, covered with water	80–90
Silverside	110–120

🕒 Duration

# Steam cooking

---

## Rice

Rice swells when cooked and needs to be cooked in liquid. The proportion of rice to liquid will vary depending on the type of rice.

The rice absorbs all the liquid during the cooking process so that none of the nutrients are lost.

## Settings

Automatic programmes  | Rice | ... |

or

Steam cooking 

Temperature: 100 °C

Duration: see chart

	Ratio Rice : Liquid	 [min.]
Basmati rice	1 : 1.5	15
Parboiled rice	1 : 1.5	23–25
Arborio rice		
Milk rice	1 : 2.5	30
Risotto rice	1 : 2.5	18–19
Brown rice	1 : 1.5	26–29
Wild rice	1 : 1.5	26–29

 Duration

## Grains

Grain swells when cooked and needs to be cooked in liquid. The proportion of grain to liquid will vary depending on the type of grain.

Grain can be cooked whole or cracked.

## Settings

Automatic programmes  | Grains | ... |

or

Steam cooking 

Temperature: 100 °C

Duration: see chart

	Ratio Grain : Liquid	 [min.]
Amaranth	1 : 1.5	15–17
Bulgur	1 : 1.5	9
Green spelt, whole	1 : 1	18–20
Green spelt, cracked	1 : 1	7
Oats, whole	1 : 1	18
Oats, cracked	1 : 1	7
Millet	1 : 1.5	10
Polenta	1 : 3	10
Quinoa	1 : 1.5	15
Rye, whole	1 : 1	35
Rye, cracked	1 : 1	10
Wheat, whole	1 : 1	30
Wheat, cracked	1 : 1	8

 Duration

# Steam cooking

---

## Pasta/Noodles

### Dry pasta and noodles

Dry pasta and noodles swell when they are cooked and need to be cooked in liquid. The liquid must cover the pasta or noodles. Using hot liquid gives better results.

Increase the cooking time stated by the manufacturer by approx. 1/3.

### Fresh food

Fresh pasta and noodles, such as those you can buy from the supermarket chilled counter, do not need to absorb water. Cook in a greased, perforated container.

Separate any pieces of pasta or noodles which have stuck together and spread them out in the cooking container.

### Settings

Automatic programmes  | Pasta | ... |

or

Steam cooking 

Temperature: 100 °C

Duration: see chart

<b>Fresh pasta / noodles</b>	 [min.]
Gnocchi	2
Knöpfli	1
Ravioli	2
Spätzle	1
Tortellini	2
<b>Dry pasta / noodles, covered with water</b>	
Flat noodles / Fettuccine	14
Vermicelli	8

 Duration

## European dumplings

Ready-made dumplings in wrappers need to be covered completely with water. Otherwise they will not absorb enough water and will fall apart, even if steeped in water prior to cooking.

Cook fresh dumplings in a greased, perforated container.

### Settings

Automatic programmes  | Pasta | ... |

or

Steam cooking 

Temperature: 100 °C

Duration: see chart

	 [min.]
Steamed dumplings	30
Yeast dumplings	20
Boil-in-the-bag potato dumplings	20
Boil-in-the-bag bread dumplings	18–20

 Duration

# Steam cooking

---

## Dried pulses

Soak pulses for at least 10 hours in cold water before cooking. Soaking makes the pulses more digestible and shortens the cooking duration required. Soaked pulses must be covered with liquid during cooking.

**Lentils** do not need to be soaked before cooking.

With unsoaked pulses a certain ratio of pulses to liquid is required.

## Settings

Automatic programmes  | Pulses | ... |

or

Steam cooking 

Temperature: 100 °C

Duration: see chart

Soaked	
	 [min.]
<b>Beans</b>	
Kidney beans	55–65
Adzuki beans	20–25
Black beans	55–60
Borlotti beans	55–65
Haricot beans	34–36
<b>Peas</b>	
Yellow split peas	40–50
Green peas, shelled	27

 Duration

## Steam cooking

Unsoaked		
	Ratio Pulses : Liquid	⌚ [min.]
<b>Beans</b>		
Kidney beans	1 : 3	130–140
Adzuki beans	1 : 3	95–105
Black beans	1 : 3	100–120
Borlotti beans	1 : 3	115–135
Haricot beans	1 : 3	80–90
<b>Lentils</b>		
Brown lentils	1 : 2	13–14
Red lentils	1 : 2	7
<b>Peas</b>		
Yellow split peas	1 : 3	110–130
Green peas, shelled	1 : 3	60–70

⌚ Duration

# Steam cooking

---

## Hen's eggs

Use a perforated container to prepare boiled eggs in the steam oven.

The eggs do not need to be pierced before cooking as they are gradually warmed during the heating-up phase and so do not burst when they are cooked with steam.

When using a solid container for preparing egg dishes, remember to grease it first.

## Settings

Automatic programmes  | Hen's eggs | ... |

or

Steam cooking 

Temperature: 100 °C

Duration: see chart

	 [min.]
<b>Small (S)</b> soft medium hard	 3 5 9
<b>Medium (M)</b> soft medium hard	 4 6 10
<b>Large (L)</b> soft medium hard	 5 6–7 12
<b>Extra large (XL)</b> soft medium hard	 6 8 13

 Duration

## Fruit

Cook fruit in a solid container so that none of the juice is lost. If you wish to cook fruit in a perforated container, place a solid container directly underneath it to collect the juice.

**Useful tip:** You can use the collected juice to prepare a glaze for a fruit flan.

### Settings

Automatic programmes  | Fruit | ... |

or

Steam cooking 

Temperature: 100 °C

Duration: see chart

	 [min.]
Apple chunks	1–3
Pear chunks	1–3
Cherries	2–4
Mirabelle plums	1–2
Nectarine/Peach chunks	1–2
Plums	1–3
Quinces, diced	6–8
Rhubarb chunks	1–2
Gooseberries	2–3

 Duration

## Sausages

### Settings

Automatic programmes  | Sausages  
| ... |

or

Steam cooking 

Temperature: 90 °C

Duration: see chart

Sausages	 [min.]
Frankfurters	6–8
Sausages	6–8
White sausages	6–8

 Duration

# Steam cooking

---

## Shellfish

### Preparation

Defrost frozen shellfish before cooking with steam.

Peel, remove and discard the intestines, and then wash the shellfish.

### Cooking containers

If using a perforated container, grease it first or line it with baking paper.

### Duration

The longer shellfish are cooked, the tougher they become. Use the cooking durations given in the chart.

When cooking shellfish in sauce or stock, we recommend that you increase the cooking duration quoted by a few minutes.

### Settings



Automatic programmes  | Shellfish | ... |

or

Steam cooking 

Temperature: see chart

Duration: see chart

	 [°C]	 [min.]
Crevettes	90	3
Prawns	90	3
King prawns	90	4
Small shrimps	90	3
Crayfish	95	10–15
Large shrimps	90	3

 Temperature,  duration

## Mussels

### Fresh food

 Danger of food poisoning from spoiled mussels.  
Spoiled mussels can cause food poisoning.  
Only cook mussels which are closed.  
Do not eat mussels which have not opened after being cooked.

Steep fresh mussels in water for a few hours before cooking to rinse out any sand. Then scrub the mussels thoroughly to clean them.

### Frozen

Defrost frozen mussels before cooking.

### Duration

The longer mussels are cooked, the harder they become. Use the cooking durations given in the chart.

### Settings



Automatic programmes  | Mussels and clams | ... |

or

Steam cooking 

Temperature: see chart

Duration: see chart

	 [°C]	 [min.]
Goose barnacles	100	2
Cockles	100	2
Blue mussels	90	12
Scallops	90	3
Razor clams	100	2–4
Vongole	90	2–4

 Temperature,  duration

# Steam cooking

## Menu cooking

Before cooking meals with the manual Menu cooking function, switch off steam reduction (see “Settings – Steam reduction”).

Menu cooking involves cooking various foods with different cooking times in order to serve them all together in one meal, e.g. rosefish fillet with rice and broccoli.

Foods are placed in the steam oven at different times so that they are all ready at the same time.

### Shelf level

Place foods that produce a lot of liquids (e.g. fish) or have a distinctive colour (e.g. beetroot) directly above the glass tray or condensate tray (depending on the model). This avoids any transfer of flavour or colour to other food by preventing liquid dripping onto food below it.

### Temperature

Whole meals should be cooked at a temperature of 100 °C as this is the temperature required to cook the majority of foods.

Do not cook a whole meal at the lowest temperature when different temperatures are required for different types of food, e.g. 85 °C for seabream and 100 °C for potatoes.

If the recommended cooking temperature for the food is 85 °C for example, try cooking it at 100 °C and testing the result. Some delicate types of fish with a soft structure, e.g. flounder will become very firm when cooked at 100 °C.

## Duration

If you increase the recommended temperature, shorten the cooking duration by approx.  $\frac{1}{3}$ .

### Example:

#### Food cooking durations

(see cooking charts in “Steam cooking”)

Parboiled rice	24 minutes
Rosefish fillet	6 minutes
Broccoli	4 minutes

#### Calculation of set cooking durations:

24 minutes minus  
6 minutes = 18 minutes (1st cooking duration: rice)

6 minutes minus 4 minutes = 2 minutes  
(2nd cooking duration: rosefish fillet)

Remaining time = 4 minutes  
(3rd cooking duration: broccoli)

Duration	24 min. – rice		
		6 min. - rosefish fillet	
			4 min. - broccoli
Setting	18 min.	2 min.	4 min.

## Cooking a whole menu

- Place the rice in the oven first.
- Set the first cooking duration:  
18 minutes.
- After the 18 minutes, place the fish in  
the oven.
- Set the second cooking duration:  
2 minutes.
- After the 2 minutes, place the  
broccoli in the oven.
- Set the third cooking duration:  
4 minutes.

## Sous-vide (vacuum) cooking

---

With this gentle cooking method, food is cooked slowly and at a low, constant temperature in vacuum packaging.

With vacuum cooking, no moisture evaporates during cooking and all nutrients and flavours are retained.

The cooking result has an intensive taste and food is cooked evenly.

Use only fresh food which is in a good condition.

Ensure hygienic conditions and that food has not been out of the refrigerator too long, e.g. during transportation.

Use only heat-stable, boiling-resistant vacuum bags.

Do not cook food in the sales packaging, such as vacuum-packed frozen food as it is possible that the packaging used is not suitable for vacuum cooking.

Do not use the vacuum bag more than once.

Vacuum-seal the food in a chamber system vacuum sealer only.

## Sous-vide (vacuum) cooking

---

### Important notes on use

For an optimum cooking result:

- Use herbs and spices more sparingly than with conventional methods because the impact on the taste of the food will be stronger. You can also cook the food unseasoned and add seasoning after cooking.
  - The cooking duration is reduced when salt, sugar, and liquids are added.
  - The food becomes firmer if acidic foods, such as lemon or vinegar are added.
  - Do not use alcohol or garlic as this can cause an unpleasant taste.
  - Only use vacuum sealing bags that match the size of the food. If the vacuum bag is too big, too much air can remain inside.
  - If you want to cook several pieces of food in one vacuum bag, put them side by side in the bag.
  - If you want to cook food in several vacuum sealing bags at once, put the bags side by side on the rack.
  - The cooking durations depend on the thickness of the food.
  - With higher temperatures and/or longer cooking durations, the appliance may run low on water. Check the display from time to time.
- Keep the door closed during the cooking process. Opening the door extends the cooking process and can change the cooking result.
  - Cooking at a lower temperature and for a longer duration can result in increased residual water in the cooking compartment. This does not affect the cooking results.
  - Temperatures and cooking durations from sous-vide recipes cannot always be emulated exactly. Alter the settings to achieve the degree of cooking you want.

# Sous-vide (vacuum) cooking

---

## Useful tips

- In order to reduce cooking times, you can vacuum seal food items 1–2 days before the cooking programme. Store the vacuum-sealed food in the refrigerator at no more than 5 °C. In order to preserve quality and flavour, the food should be cooked no later than 2 days afterwards.
- Freeze liquids such as marinades before vacuum sealing to prevent them from escaping from the bag.
- Fold the edges of the vacuum sealing bag outwards for filling. This will give you clean, perfect weld seams.
- If you do not want to eat the food straight after cooking, put it in iced water immediately and allow it to cool down completely. After this, store the food at temperatures no greater than 5 °C.  
This way, you can retain the food's quality and flavour while keeping it fresh for longer.  
**Exception:** Poultry must be eaten straight after the cooking programme.
- After cooking, cut the vacuum bag on all sides for easier access to the food.
- Briefly fry meat and firm types of fish (such as salmon) before serving. This will help to develop a roasted aroma.
- Use the brine or marinade of vegetables, fish, or meat to make a sauce.
- Serve the food on pre-warmed plates.

## Using the Sous-vide function

- Rinse the food with cold water and dry it.
- Place the food in a vacuum bag and add spices or liquid if desired.
- Vacuum seal the food in a chamber system vacuum sealer.
- Place the glass tray on shelf level 1.
- For the best cooking results, place the rack on shelf level 2.
- Place the vacuum-sealed food on the rack (next to each other if there are several bags).
- Select Sous-vide .
- Change the recommended temperature if necessary.
- Confirm with *OK*.
- Set further settings as necessary (see “Operation”).

## Possible causes for poor results

### The vacuum bag has opened:

- The weld seam was not clean or stable enough and came undone.
- The bag was damaged by a sharp bone.

### The food has an unpleasant or strange taste:

- Incorrect storage of the food; the food was kept out of the refrigerator for too long.
- The food was contaminated with bacteria before it was vacuum sealed.
- Too much of ingredients such as spices were added.
- The bag or weld seam were not in perfect order.
- The vacuum was insufficient.
- The food was not eaten or chilled immediately after cooking.

## Sous-vide (vacuum) cooking

The cooking durations given in the tables are guidelines only. We recommend selecting the shorter duration initially. You can cook for longer if necessary. The cooking duration only begins when the set temperature is reached.

Food	Added in advance		🌡️ [°C]	⌚ [min.]
	Sugar	Salt		
<b>Fish</b>				
Blue eye trevalla/Ling fillet, 2.5 cm thick		x	54	35
Salmon fillet, 2–3 cm thick		x	52	30
Stargazer/Monkfish fillet		x	62	18
Pikeperch fillet, 2 cm thick		x	55	30
<b>Vegetables</b>				
Cauliflower florets, medium to large		x	85	40
Hokkaido pumpkin, sliced		x	85	15
Kohlrabi, sliced		x	85	30
White asparagus, whole	x	x	85	22–27
Sweet potato, sliced		x	85	18
<b>Fruit</b>				
Pineapple, sliced	x		85	75
Apples, sliced	x		80	20
Baby bananas, whole			62	10
Peaches, halved	x		62	25–30
Rhubarb chunks			75	13
Plums, halved	x		70	10–12
<b>Other</b>				
Beans, white, soaked at a 1:2 ratio (beans to liquid)		x	90	240
Prawns, peeled and deveined		x	56	19–21
Hen's egg, whole			65–66	60
Scallops, removed from shell			52	25
Shallots, whole	x	x	85	45–60

🌡️ Temperature, ⌚ duration

## Sous-vide (vacuum) cooking

Food	Added in advance		🌡️ [°C]		🕒 [min.]
	Sugar	Salt	Medium*	Well-done*	
<b>Meat</b>					
Duck breast, whole		x	66	72	35
Saddle of lamb (on the bone)			58	62	50
Beef tenderloin, 4 cm thick			56	61	120
Beef rump steak, 2.5 cm thick			56	–	120
Pork fillet, whole		x	63	67	60

🌡️ Temperature, 🕒 duration

\* Degree of doneness

The “Well-done” degree of doneness has a higher core temperature than “Medium,” but is not cooked through in the classical sense.

# Sous-vide (vacuum) cooking

---

## Reheating

Only reheat brassicas, such as kohlrabi and cauliflower, in combination with a sauce. Without sauce, an unpleasant cabbage-like taste and grey-brown colour may develop.

Foods with a short cooking time and those which have a different degree of doneness when reheated, e.g. fish, are not suited to being reheated.

## Preparation

Immediately after cooking, place the food in ice cold water and leave for approximately one hour. The rapid cooling inhibits continued cooking of the food. This means the ideal degree of doneness of the food remains as it is. Store the food afterwards in the refrigerator at max. 3 °C.

Please note that the quality of food deteriorates the longer it is stored. We recommend storing food in the refrigerator for no longer than five days before reheating it.

## Settings

Sous-vide 

Temperature: see chart

Duration: see chart

# Sous-vide (vacuum) cooking

## Reheating in the Sous-vide function

The durations specified in the chart are guidelines only. You can make the duration longer if necessary. The cooking duration only begins when the set temperature is reached.

Food	🌡️ [°C]		🕒 <sup>2</sup> [min.]
	Medium <sup>1</sup>	Well-done <sup>1</sup>	
<b>Meat</b>			
Saddle of lamb (on the bone)	58	62	30
Beef tenderloin, 4 cm thick	56	61	30
Beef rump steak, 2.5 cm thick	56	–	30
Pork fillet, whole	63	67	30
<b>Vegetables</b>			
Cauliflower florets, medium to large <sup>3</sup>	85		15
Kohlrabi, sliced <sup>3</sup>	85		10
<b>Fruit</b>			
Pineapple, sliced	85		10
<b>Other</b>			
Beans, white, soaked at a 1:2 ratio (beans to liquid)	90		10
Shallots, whole	85		10

🌡️ Temperature, 🕒 duration

<sup>1</sup> Degree of doneness

The “Well-done” degree of doneness has a higher core temperature than “Medium,” but is not cooked through in the classical sense.

<sup>2</sup> The durations apply to vacuum-sealed food with an initial temperature of approx. 5 °C (refrigerator temperature).

<sup>3</sup> Reheat only in sauce.

# Other applications

---

## Reheat with steam

To reheat food which was cooked using the sous-vide method, use the Sous-vide  function (see “Sous-vide – Reheating”).

The steam oven is very effective at reheating food gently, without drying it out or cooking it further. The food reheats evenly and does not need to be stirred during the reheating process.

You can reheat individual dishes or plated meals which have been prepared previously (e.g. meat, vegetables and potatoes).

### Suitable containers

Small quantities can be reheated on a plate, larger quantities should be placed in a cooking container.

### Duration

The number of plates or containers has no bearing on the time.

The times listed in the table relate to an average portion per plate. Increase the duration for larger quantities.

## Useful tips

- Do not reheat large items, such as a joint of roast meat, whole. Divide it into portions and reheat these as plated meals.
- Compact items, such as stuffed capsicum, roulades or dumplings, should be cut in half.
- Reheat sauces separately. Exceptions are dishes such as goulash, which is cooked in sauce.
- Cover food when reheating it. This will avoid steam condensing on the crockery.
- Please note that breaded items, such as schnitzel, will not retain their crispness when they are reheated.

## Heating food

- Cover the food being warmed up with a plate or foil that is resistant to temperatures up to 100 °C and to steam.
- Place the food on the rack or in a cooking container.

## Settings

Reheat  | Steam cooking

or

Steam cooking 

Temperature: 100 °C

Duration: see chart

## Other applications

The durations specified in the chart are guidelines only. We recommend selecting the shorter duration initially. You can make the duration longer if necessary.

Food	🕒* [min.]
<b>Vegetables</b>	
Carrots Cauliflower Kohlrabi Beans	6–7
<b>Side dishes</b>	
Pasta Rice	3–4
Potatoes, halved lengthways	12–14
European dumplings	15–17
<b>Meat and poultry</b>	
Sliced meat, 1.5 cm thick Roulades, sliced Goulash Lamb stew	5–6
Meatballs	13–15
Chicken schnitzel Turkey schnitzel	7–8
<b>Fish</b>	
Fish fillets, 2 cm thick	6–7
Fish fillets, 3 cm thick	7–8
<b>Plated meals</b>	
Spaghetti with tomato sauce	13–15
Roast pork, potatoes, vegetables	12–14
Stuffed capsicum (halved), rice	13–15
Chicken fricassee, rice	7–8
Vegetable soup	2–3
Creamy soup	3–4

## Other applications

---

Food	⌚* [min.]
Consommé	2-3
Casserole	4-5

⌚ Duration

\* These times apply to food heated on a plate and covered with a plate.

## Defrost with steam

It is much quicker to defrost items in the steam oven than at room temperature.

 Risk of infection from bacteria. Bacteria such as salmonella can cause life-threatening food poisoning.

It is particularly important to observe food hygiene rules when defrosting fish and meat, and in particular when defrosting poultry.

Do not use the liquid produced during defrosting.

Process the food as required as soon as it has been defrosted.

## Temperature

60 °C is the best temperature for defrosting.

**Exceptions:** 50 °C for minced meat and game.

## Before and after defrosting

Remove any packaging before defrosting.

**Exceptions:** Leave bread, biscuits and cakes in their packaging as otherwise they will absorb moisture and become soft.

Allow food to stand at room temperature for a few minutes after defrosting. The standing time is necessary to allow the even distribution of heat from the outside to the inside.

## Cooking containers

Use a perforated container with a glass tray or condensate tray (depending on model) underneath it when defrosting food which will drip, such as poultry. This way food will not be lying in defrosted liquid.

Foods which do not drip can be defrosted in a solid cooking container.

## Useful tips

- Fish does not need to be fully defrosted before cooking. Defrost so that the surface is sufficiently thawed to take herbs and seasoning. Depending on the thickness of the fish, 2–5 minutes is generally enough.
- When defrosting food which has frozen together, e.g. berries and meat portions, separate them half-way through the defrosting time.
- Do not refreeze food once it has thawed.
- Defrost frozen ready meals according to the instructions on the packaging.

## Settings

Defrost  | Steam cooking

or

Steam cooking 

Temperature: see chart

Defrosting duration: see chart

Standing time: see chart

## Other applications

The durations specified in the chart are guidelines only. We recommend selecting the shorter defrosting duration initially. You can make the defrosting duration longer if necessary.

Frozen food	Quantity	🌡️ [°C]	🕒 [min.]	⌚ [min.]
<b>Dairy products</b>				
Sliced cheese	125 g	60	15	10
Quark	250 g	60	20–25	10–15
Cream	250 g	60	20–25	10–15
Soft cheese	100 g	60	15	10–15
<b>Fruit</b>				
Apple sauce	250 g	60	20–25	10–15
Apple pieces	250 g	60	20–25	10–15
Apricots	500 g	60	25–28	15–20
Strawberries	300 g	60	8–10	10–12
Raspberries/Red/ Blackcurrants	300 g	60	8	10–12
Cherries	150 g	60	15	10–15
Peaches	500 g	60	25–28	15–20
Plums	250 g	60	20–25	10–15
Gooseberries	250 g	60	20–22	10–15
<b>Vegetables</b>				
Frozen in a block	300 g	60	20–25	10–15
<b>Fish</b>				
Fish fillets	400 g	60	15	10–15
Trout	500 g	60	15–18	10–15
Lobster	300 g	60	25–30	10–15
Small shrimps	300 g	60	4–6	5
<b>Ready meals</b>				
Meat, vegetables, sides / Casserole / Soup	480 g	60	20–25	10–15

## Other applications

Frozen food	Quantity	🌡️ [°C]	🕒 [min.]	⌚ [min.]
<b>Meat</b>				
Roast meat slices	125–150 g each	60	8–10	15–20
Minced meat	250 g	50	15–20	10–15
	500 g	50	20–30	10–15
Stew	500 g	60	30–40	10–15
	1000 g	60	50–60	10–15
Liver	250 g	60	20–25	10–15
Saddle of hare	500 g	50	30–40	10–15
Roebuck saddle	1000 g	50	40–50	10–15
Schnitzel/Chops/Sausages	800 g	60	25–35	15–20
<b>Poultry</b>				
Chicken	1000 g	60	40	15–20
Chicken thighs	150 g	60	20–25	10–15
Chicken fillet	500 g	60	25–30	10–15
Turkey drumsticks	500 g	60	40–45	10–15
<b>Baked goods</b>				
Puff pastries/Yeast buns	–	60	10–12	10–15
Creamed mixture cakes/ biscuits	400 g	60	15	10–15
<b>Bread/Rolls</b>				
Bread rolls	–	60	30	2
Rye bread, sliced	250 g	60	40	15
Whole grain bread, sliced	250 g	60	65	15
White bread, sliced	150 g	60	30	20

🌡️ Temperature 🕒 Defrosting duration ⌚ Standing time

## Other applications

---

### Blanch

Blanch fruit and vegetables before freezing them. Blanching helps maintain the quality of the produce when it is frozen.

Blanching vegetables also helps them retain their original colour.

- Put the prepared vegetables (cleaned, washed, chopped etc.) into a perforated cooking container and place in the steam oven.
- Once blanched, plunge the vegetables into ice cold water to cool them down quickly. Drain them well.

### Settings

Other  | Blanch

or

Steam cooking 

Temperature: 100 °C

Blanching time: 1 minute

### Bottling

Only use unblemished, fresh produce which is in good condition.

### Glass jars

Use clean glass jars and accessories and check them for any defects. Glass jars with twist off lids or glass lids with a rubber seal are suitable.

Make sure that all the glass jars are the same size so that bottling is carried out evenly.

After you have filled the jars with the bottled produce, clean the glass rims with a clean cloth and hot water and then seal the jars.

### Fruit

Sort fruit carefully, rinse it briefly but thoroughly and allow it to drain. Take great care when cleaning soft fruit as it is very delicate and squashes easily.

Remove any peel, stalks, cores or stones. Cut up large fruit. For example, cut apples into slices.

If you are bottling fruit with stones (e.g. plums, apricots) without removing the stones, pierce the fruit several times with a fork or wooden skewer as otherwise it will burst.

### Vegetables

Rinse, clean and cut up vegetables.

Vegetables should be blanched before bottling to help them retain their colour (see “Special applications – Blanching”).

### Fill volume

Fill the glass jars with produce up to no more than 3 cm below the rim. Do not pack it down as this will damage the cell walls of the produce. Tap the jar gently onto a cloth to help distribute the contents evenly. Fill the jars with liquid. The produce must be completely covered.

Use a sugar solution for fruit and a salt or vinegar solution for vegetables.

### Meat and sausages

Briefly fry or cook the meat before bottling. Use the juices with some added water, or the broth in which the meat was cooked, as the liquid content of the jars. Make sure there is no grease on the rim of the jars.

When bottling sausages, only fill the jars to halfway as the meat will rise during the bottling process.



### Useful tips

- Make use of residual heat by leaving the jars in the oven for 30 minutes after it has switched off.
- Then cover the jars with a cloth and allow to cool for approx. 24 hours.

### Bottling food

- Place the rack on shelf level 1.
- Place the closed jars on the rack. The jars must not touch each other.

### Settings

Other  | Bottling  
or  
Steam cooking 

Temperature: see chart

Bottling duration: see chart

## Other applications

Food	🌡️ [°C]	🕒* [min.]
<b>Berries</b>		
Red / Blackcurrants	80	50
Gooseberries	80	55
Cranberries	80	55
<b>Fruit with stones</b>		
Cherries	85	55
Mirabelle plums	85	55
Plums	85	55
Peaches	85	55
Greengage plums	85	55
<b>Fruit with pips</b>		
Apples	90	50
Apple sauce	90	65
Quinces	90	65
<b>Vegetables</b>		
Beans	100	120
Broad beans	100	120
Gherkins	90	55
Beetroot	100	60
<b>Meat</b>		
Pre-cooked	90	90
Roasted	90	90

🌡️ Temperature, 🕒 Duration

\* Bottling durations apply to 1.0 l jars. If using 0.5 l jars, reduce the duration by 15 minutes. If using 0.25 l jars, reduce the duration by 20 minutes.

### Disinfect items

The steam oven will disinfect baby bottles and other containers so that at the end of the programme they are as germ free as they would have been if boiled. Check beforehand that all parts, teats etc. are declared by the manufacturer to be heat resistant to 100 °C and also that they can withstand hot steam.

Dismantle, clean and thoroughly rinse baby bottles. Reassemble the bottles only after they have completely dried. This prevents recontamination.

- Place the individual items on the rack or in a perforated container (on their sides or with the opening facing downwards) ensuring that they do not touch one another. This will allow hot steam to reach them from all sides.

### Settings

Other  | Disinfect items

Duration: 1 minute to 10 hours

or

Steam cooking 

Temperature: 100 °C

Duration: 15 minutes

### Prove yeast dough

- Prepare the dough according to the recipe.
- Place the dough in a bowl on the rack.

### Settings

Other  | Prove yeast dough

Duration: as per recipe instructions

or

Steam cooking 

Temperature: 40 °C

Duration: as per recipe instructions

## Other applications

---

### Heat damp towels

- Moisten towels and then roll them up.
- Place them beside one another in a perforated cooking container.

#### Settings

Automatic programmes  | Special | Heat damp towels

or

Steam cooking 

Temperature: 70 °C

Duration: 2 minutes

### Dissolve gelatine

- Soften **gelatine leaves** by leaving them in a bowl of cold water for 5 minutes. The gelatine leaves have to be fully covered with water. Remove the gelatine leaves from the bowl and squeeze them out. Empty the bowl. Place the squeezed gelatine leaves back in the bowl.
- **Gelatine powder:** Place the gelatine powder in a bowl and add water according to the instructions on the packaging.
- Cover the bowl and place on the rack.

#### Settings

Automatic programmes  | Special | Dissolve gelatine

or

Steam cooking 

Temperature: 90 °C

Cooking duration: 1 minute

### Decrystallise honey

- Loosen the lid and place the jar of honey in a perforated cooking container.
- Stir the honey once during the process.

#### Settings

Automatic programmes  | Special |  
Decrystallise honey

or

Steam cooking 

Temperature: 60 °C

Duration: 90 minutes (irrespective of the size of jar or the amount of honey in the jar)

### Melt chocolate

You can use the steam oven for melting any type of chocolate.

When using a cake glaze, place it in a perforated cooking container, leaving it in its packaging.

- Break the chocolate into small pieces.
- Place large quantities in a solid container and small quantities in a cup or a bowl.
- Cover the container or the dish with a lid or with foil that is resistant to temperatures up to 100 °C and to hot steam.
- Stir large quantities once during cooking.

#### Settings

Automatic programmes  | Special | Melt chocolate

or

Steam cooking 

Temperature: 65 °C

Duration: 20 minutes

## Other applications

---

### Make yoghurt

To prepare yoghurt, you will need milk and live culture or yoghurt starter powder, e.g. from a health food store.

Use natural yogurt with live culture and without additives. Do not use heat-treated yogurt.

The yoghurt must be fresh (short storage time).

You can use either unchilled long-life milk or fresh milk.

Long-life milk can be used as it is – no further preparation is required. Fresh milk must first be heated to 90 °C (do not boil it) and then cooled down to 35 °C. Fresh milk will give a better set than long-life milk.

The yoghurt and milk should have the same percentage fat.

Do not move or shake the jars while the yoghurt is fermenting.

Immediately after preparation, leave the yoghurt to cool in the fridge.

The firmness, fat content and cultures used in the yoghurt starter all affect the consistency of homemade yoghurt. Not all yoghurts are equally suitable as yoghurt starters.

**Useful tip:** If you are using yoghurt starter powder, you can prepare the yoghurt from a mixture of milk and cream. For that, mix  $\frac{3}{4}$  litre milk with  $\frac{1}{4}$  litre cream.

- Mix 100 g yoghurt with 1 litre of milk or make up the mixture with yoghurt enzyme, following the instructions on the packaging.
- Pour the mixture into glass jars and seal the jars.
- Place the sealed jars in a perforated cooking container or on the rack. The jars must not touch each other.
- Straight after the cooking duration has finished, place the jars in the refrigerator. Take care not to shake the jars unnecessarily.

### Settings

Automatic programmes  | Special |  
Make yoghurt

or

Steam cooking 

Temperature: 40 °C

Duration: 5:00 hours

### Possible causes for poor results

#### Yoghurt is not set:

Incorrect storage of the yoghurt starter, too much time out of the refrigerator, packaging was damaged, milk was insufficiently heated.

#### Liquid has not been removed:

Jars were moved, the yoghurt cooled down too slowly.

#### Yoghurt is grainy:

The milk was heated too high, it was not free of imperfections, the milk and yoghurt starter were not stirred evenly.

### Render fat

The bacon will not become brown.

- Place the bacon (diced or rashers) in a solid cooking container.
- Cover the container with foil that is temperature-resistant up to 100 °C and resistant to steam.

### Settings

Automatic programmes  | Special |  
Render fat

or

Steam cooking   
Temperature: 100 °C  
Duration: 4 minutes

### Sweat onions

Sweating means cooking the onions in their own juices, with the addition of a little fat if necessary.

- Cut the onions up into small pieces and place them in a solid cooking container with a little butter.
- Cover the container with foil that is temperature-resistant up to 100 °C and resistant to steam.

### Settings

Automatic programmes  | Special |  
Sweat onions

or

Steam cooking   
Temperature: 100 °C  
Duration: 4 minutes

# Other applications

---

## Extracting juice

This appliance is ideal for extracting juice from soft, firm and hard fruit.

It is best to use overripe fruit, as the riper the fruit, the greater the quantity of juice produced. Very ripe fruit will also produce a more intense flavour.

## Preparation

Sort and rinse the fruit, and cut out any blemishes.

Remove the stalks from grapes and morello cherries as these are bitter. Berries do not need to have their stalks removed.

Dice larger fruit such as apples into approximately 2 cm cubes. The harder the fruit, the smaller the pieces should be.

## Useful tips

- Try experimenting with mild and tart flavours. For example, mix apples with elderberries.
- Adding sugar will increase the quantity of juice produced and improve the flavour. Sprinkle the fruit with sugar and leave to absorb for a few hours before juicing. For 1 kg of sweet fruit add 50–100 g of sugar, and for 1 kg of tart fruit add 100–150 g of sugar.
- If you wish to bottle the juice rather than consume it straight away, pour it whilst hot into hot, sterilised bottles up to the rim, and then seal immediately with sterilised rubber tops.

## Extracting juice from fruit

- Put the prepared fruit (cleaned, washed, chopped etc.) into a perforated cooking container.
- Place a solid container or a glass tray or condensate tray (depending on the model) underneath to catch the juice.

## Settings

Steam cooking 

Temperature: 100 °C

Duration: 40-70 minutes

## Skinning fruit and vegetables

- Cut a cross in the top of tomatoes, nectarines etc. This will allow the skin to be removed more easily.
- Place the fruit/vegetables in a perforated cooking container.
- To blanch almonds, it is important to plunge them into cold water as soon as they are taken out of the oven as otherwise the skin cannot be removed.

### Settings

Steam cooking 

Temperature: 100 °C

Duration: see chart

Produce	 [min.]
Apricots	1
Almonds	1
Nectarines	1
Capsicum	4
Peaches	1
Tomatoes	1

 Duration

## Preserving apples

You can treat homegrown apples in the steam oven to increase the length of time for which you can store them. Once treated, the apples will keep for 5 to 6 months when stored in a dry, cool and well-ventilated place. This method is only suitable for apples and not for other types of fruit.

### Settings

Automatic programmes  | Fruit | Apples | Whole

or

Steam cooking 

Temperature: 50 °C

Preserving time: 5 minutes

## Preparing custard royale

- Stir 6 eggs into 375 ml milk (do not beat into a foam).
- Season the egg/milk mixture and pour into a solid cooking container greased with butter.

### Settings

Steam cooking 

Temperature: 100 °C

Duration: 4 minutes

## Rapid steam cooking

You can defrost, reheat and cook food with a combination of steam and microwave power in the Rapid steam cooking  function.



During the heating-up phase, the oven compartment is initially heated to the set temperature using just steam power. As soon as this temperature is reached, the microwave switches on so that the steam generator and magnetron are both switched on throughout the entire cooking phase.

Just like cooking with steam only, the cooking duration does not begin until the set temperature is reached.

The combined Rapid steam cooking  function has a number of advantages, including the following:

- Food takes less time to cook, as it cooks more quickly than using the steam function alone
- Food will not overcook or dry out as it can with microwave power
- Food can be defrosted and reheated in a single process
- Food does not need to be stirred during the cooking process

### Defrosting and reheating in the Rapid steam cooking function

	 [W]	 [min.]	 [°C]	Container
<b>Reheating plated meals</b> <sup>1, 2</sup>				
Pasta with tomato sauce, 400 g (ratio 5:3)	300	7–8	90	Deep plate
Rissoles with mashed potato and red cabbage, 450 g	300	11	85	Deep plate
<b>Defrosting and reheating</b> <sup>1, 2</sup>				
Frozen casseroles/soups 250 g	300	10–11	95	Bowl
Frozen casseroles/soups 500 g	300	15–16	90	Bowl

 Microwave power,  Duration,  Temperature

<sup>1</sup> Do **not** use a cover.

<sup>2</sup> Place the food in the glass tray on shelf level 1.

## Cooking new potatoes (firm)

- Place the glass tray on shelf level 1.
- Place the washed new potatoes adjacent to each other in a perforated cooking container.

### Settings



Automatic programmes  | Vegetables | Potatoes | New potatoes | Firm | ... | Rapid steam cooking

or

Rapid st. cooking 

Microwave power/Temperature: 80 W + 100 °C

Duration: see chart

Size of potatoes	Quantity	 <sup>4</sup>	 [min.]
Small (40–60 g)	200 g (4)	2	15
	600 g (12)	2	18
	1000 g (20)	2	21
Medium (90–110 g)	200 g (2)	2	18
	600 g (6)	2	21
	1000 g (10)	2	24
Large (140–160 g)	300 g (2)	2	22
	600 g (4)	2	25
	900 g (6)	2	29

<sup>4</sup> Shelf level,  Cooking duration

# Rapid steam cooking

## Cooking rice

Rice swells when cooked and needs to be cooked in liquid. The proportion of rice to liquid will vary depending on the type of rice.

The rice absorbs all the liquid during the cooking process so that none of the nutrients are lost.

- Add the rice with the liquid in a solid cooking container.

## Settings





Automatic programmes  | Rice | ... | Rapid steam cooking

or

Rapid st. cooking 

Microwave power/Temperature: see chart

Duration: see chart

	Ratio Rice : liquid	To add	 4 1	 [W]	 [min.]	 [°C]
Basmati rice	1 : 2	Salt	2	300	9	100
Parboiled rice	1 : 2	Salt	2	150	17	100
Milk rice	1 : 3	Sugar <sup>1</sup>	2	150	21	100

 4  
1 Shelf level,  Microwave power,  Cooking duration,  Temperature

<sup>1</sup> Added after the cooking process.

## Microwave defrosting and reheating

We recommend using the following microwave power levels to defrost or reheat foods:

 [W]	Defrost
80	Very delicate food: butter, cream and butter cream gateaux, cheese
150	All other types of food
Reheat	
450	Food for babies and children
600	Various types of food; frozen ready meals which do not need browning
850	
1000	Drinks

 Microwave power

The time required depends on the nature of the food, its initial temperature and the amount to be cooked. The durations can be found in the charts on the following pages.

# Microwave defrosting and reheating

## Defrost

Gentle defrosting of frozen goods means that the vitamins and minerals are generally retained.

 Risk of infection from bacteria. Bacteria such as salmonella can cause life-threatening food poisoning.

It is particularly important to observe food hygiene rules when defrosting fish and meat, and in particular when defrosting poultry.

Do not use the liquid produced during defrosting.

Process the food as required as soon as it has been defrosted.

## Useful tips

- Place the food to be defrosted on the glass tray without its packaging. For larger food quantities, place the frozen goods in a microwave safe container and place this onto the glass tray.
- Frozen ready meals can be defrosted and then heated at the same time. Follow the instructions on the packaging.

## Defrosting frozen food

Only use heat-resistant containers which are microwave safe.

- Place the frozen food on the glass tray and place on shelf level 1.
- If necessary, cover the frozen food.
- Select Defrost .
- Select Microwave and confirm with *OK*.
- Change the recommended power level, if necessary, and confirm with *OK*.
- Change the defrosting duration, if necessary, and confirm with *OK*.

Start will be highlighted.

- Start the programme using the *OK* sensor.
- During defrosting:  
Stir, turn or rearrange the food once again. Stir the food from the outside towards the middle, as food heats more quickly from the outside.

During the standing time, the temperature is distributed evenly in the food.

- After defrosting, allow the food to stand at room temperature for a few minutes to enable the heat to spread evenly throughout the food.

## Alternative settings

Microwave 

Microwave power: see chart

Defrosting chart: see chart

Standing time: see chart

## Notes on the chart



Take note of the recommended microwave power levels, durations and standing times. These take the consistency, the quantity and the initial temperature of the food into account.

## Selecting durations



- You are generally advised to select a duration in the middle of those given in the chart.

# Microwave defrosting and reheating

## Defrosting in microwave mode

Frozen food	Quantity	 [W]	 [min.]	 [min.]	Stir/Turn/Rearrange	Cover
<b>Dairy products</b>						
Cream	250 ml	80	14	10–15	Every 5 minutes	Yes
Butter	250 g	80	12–14	5–10	At the halfway stage	Yes
Cheese slices	250 g	80	6–7	10–15; Fan out the cheese slices	After 3 minutes	No
Milk	500 ml	150	22–23	5–10	Twice every 7 minutes	Yes
<b>Cakes/Biscuits</b>						
Sand cake (1 slice)	100 g	150	1–2	5–10	–	Yes
Sand cake (1 slice)	300 g	150	3–4	10–15	At the halfway stage	Yes
Fresh fruit cake (3 slices)	3 x 100 g	150	9–10	10–15	After 5 minutes	Yes
Butter cake (3 slices)	3 x 100 g	150	5–6	10–15	At the halfway stage	Yes
Cream cake (1 slice)	100 g	80	3–4	10–15	–	Yes
Cream cake (3 slices)	3 x 100 g	80	5.5–6.5	10–15	At the halfway stage	Yes
Bread rolls (4)	4 x approx. 50 g	150	4–5	5–10	At the halfway stage	No
<b>Fruit</b>						
Strawberries, raspberries	150 g	80	11–12	5–10	At the halfway stage	Yes

## Microwave defrosting and reheating

Frozen food	Quantity	 [W]	 [min.]	 [min.]	Stir/Turn/ Rearrange	Cover
Red / Blackcurrants	250 g	80	13–14	5–10	At the halfway stage	Yes
Plums	500 g	150	13–15	5–10	At the halfway stage	Yes
<b>Meat</b>						
Minced beef	500 g	150 + 80	8–9 + 17–19	10–15	Twice every 10 minutes	No
Chicken	1000 g	150	25–28	10–15	Every 10 minutes	No
<b>Vegetables</b>						
Peas	250 g	150	9–10	5–10	At the halfway stage	Yes
Asparagus	250 g	150	11–12	5–10	After 5 minutes	Yes
Beans	500 g	150	16–17	5–10	Twice every 5 minutes	Yes
Red cabbage (in mini portions)	500 g	150	18–19	5–10	Twice every 5 minutes	Yes
Spinach (in mini portions)	300 g	150	14–15	10–15	Twice every 5 minutes	Yes

 Microwave power level,  Defrosting duration,  Standing time

# Microwave defrosting and reheating

## Reheat

It is essential that “Warning and Safety instructions - Correct use” is observed.

 Risk of injury caused by hot food.

If food for babies and children is heated at too high a temperature, they can burn themselves.

Only heat food for babies and children for 60–90 seconds at 450 W. After heating food, especially food for babies and small children, stir the food or shake the container and taste the food so that children do not get burned.

 Risk of injury from increased pressure in sealed containers or bottles.

Pressure can build up when reheating food or drinks in sealed containers, jars or bottles, which can cause them to explode.

Never cook or reheat food or liquids in sealed containers or bottles. Open containers beforehand. In the case of baby bottles, the screw top and teat must be removed.

Risk of injury caused by hot liquids.

When heating food, and in particular liquids, using the

Microwave  function, the boiling point may be reached without the production of typical bubbles.

Liquids do not boil evenly throughout.

This boiling delay can result in the liquid boiling over explosively. Take care when taking the container out of the oven, as the hot liquid can cause severe scalding. Under certain circumstances, the pressure can be so high that the door opens automatically.

Stir liquids well before reheating or cooking.

After heating, wait at least 20 seconds before removing the container from the oven.

In addition, a glass rod or similar item, if available, can be placed in the container during heating.

# Microwave defrosting and reheating

## Useful tips

- Always cover food when reheating it, except when reheating beverages or meat/fish coated in breadcrumbs.
- Please note that foods with an initial temperature of approx. 5 °C (refrigerated temperature) need longer to heat up than those at room temperature.
- If you are in any doubt that a sufficiently high food temperature has been reached, continue heating for a little longer.
- Frozen ready meals can be defrosted and then heated at the same time. Follow the instructions on the packaging.

## Heating food

Only use heat-resistant containers which are microwave safe.

- Place the food that is to be heated in the glass tray on shelf level 1.
- If necessary, cover the food.
- Select Reheat .
- Select Microwave and confirm with *OK*.
- Change the recommended power level, if necessary, and confirm with *OK*.
- Change the duration, if necessary, and confirm with *OK*.

Start will be highlighted.

- Start the programme using the *OK* sensor.
- During heating:  
Stir, turn or rearrange the food once again. Stir the food from the outside towards the middle, as food heats more quickly from the outside.

# Microwave defrosting and reheating

---



Risk of burning due to hot surfaces.

The steam oven gets hot during operation. You could burn yourself on the oven compartment, shelf runners or accessories. Droplets of water may have accumulated underneath the crockery.

Use oven gloves when working in the hot oven compartment and when removing the crockery.

During the standing time, the temperature is distributed evenly in the food.

- After heating, allow the food to stand at room temperature for a few minutes to enable the heat to spread evenly throughout the food.

## Alternative settings

Microwave

Microwave power: see chart

Duration: see chart

Standing time: see chart

## Notes on the chart



Take note of the recommended microwave power levels, durations and standing times. These take the consistency, the quantity and the initial temperature of the food into account.

## Selecting durations



- You are generally advised to select a duration in the middle of those given in the chart.



# Microwave defrosting and reheating

## Reheating in microwave mode

Food	Quantity	 [W]	 [min:s]	 [min.]	Stir/Turn/ Rearrange	Cover
<b>Drinks<sup>1</sup></b>						
Coffee, drinking temperature 60–65 °C	1 cup (200 ml)	1000	1:10–1:20	–	Before heating	No
Milk, drinking temperature 60–65 °C	1 cup/ mug (200 ml)	1000	1:20–1:30	–	Before heating	No
Water, bringing to the boil	1 cup (125 ml)	1000	1:40–1:50	–	Before heating	No
Baby bottle (milk)	Approx. 200 ml	450	1:30–1:40	1	Before serving	No
Mulled wine, grog, drinking temperature 60–65 °C	1 cup/ mug (200 ml)	1000	1:00–1:10	–	Before heating	No
<b>Food<sup>2</sup></b>						
Baby food (room temperature)	1 jar (190 g)	450	1:10–1:20	1	Before serving	No
Cutlets, cooked	200 g	600	4:20–4:50	1	At the halfway stage	No
Fish fillet, cooked	200 g	600	3:50–4:20	1	At the halfway stage	No
Roast meat in gravy	200 g	600	4:50–5:20	1	At the halfway stage	Yes
Side dishes	250 g	600	3:40–4:10	1	At the halfway stage	Yes
Vegetables	250 g	600	3:50–4:20	1	At the halfway stage and before serving	Yes

# Microwave defrosting and reheating

Food	Quantity	 [W]	 [min:s]	 [min]	Stir/Turn/Rearrange	Cover
Gravy	250 g	600	4:10–4:40	1	At the halfway stage and before serving	Yes
Soup/Casserole	250 g	600	4:00–4:30	1	At the halfway stage and before serving	Yes
	500 g	600	7:00–7:30	1	At the halfway stage and before serving	Yes

 Microwave power level,  Duration,  Standing time

- <sup>1</sup> A boiling delay can be avoided by stirring liquids before reheating them. After heating, wait at least 20 seconds before removing the container from the oven. In addition, a glass rod or similar item, if available, can be placed in the container during heating.
- <sup>2</sup> The durations apply to food with an initial temperature of approx. 5 °C. For food not normally refrigerated, durations apply to food at room temperature of approx. 20 °C. With the exception of baby food and delicate whisked sauces, food should be heated to a temperature of 70–75 °C.

The wide range of Automatic programmes enable you to achieve excellent results with ease.

## Categories

The  Automatic programmes are sorted into categories to provide a better overview. Simply select the appropriate Automatic programme for the type of food you are cooking and follow the instructions in the display.

## Using Automatic programmes

- Select Automatic programmes .



A list will appear.

- Select the desired food category (e.g. Fish).

The Automatic programmes available for the food type selected will then appear.

- Select the Automatic programme that you want to use.
- Follow the instructions in the display.

## Usage notes

- The degree of cooking is represented by a bar with seven segments. You can set the desired degree of cooking using the navigation area.
- The weights specified in the Automatic programmes refer to the weight per piece. For example, you can cook just one piece of salmon weighing 250 g or 10 pieces of salmon, each weighing 250 g, at the same time.
- The oven interior needs to be at room temperature before starting an Automatic programme.
- When you place food in the hot oven compartment, be careful when opening the door. Hot steam may escape. Step back and wait until the steam has dissipated. Avoid contact with hot steam, and do not touch the hot oven compartment walls. Danger of burning and scalding.
- For some Automatic programmes the start time can be delayed using Start at or Finish at.
- Select the  sensor to cancel an Automatic programme. When Cancel process? appears, select Yes and confirm with OK.
- If by the end of an Automatic programme the food is not cooked enough, select Continue cooking.
- Automatic programmes can also be saved as User programmes. To do this, select the  sensor after an Automatic programme has finished.

## User programmes

---

You can create and save up to 20 of your own programmes.

- You can combine up to 9 cooking stages to accurately programme your favourite or most frequently used recipes. In each cooking stage, you can select settings such as the function, temperature and cooking duration.
- You can enter the name of the programme for your recipe.

When you call up and start your programme the next time, it will run automatically.

There are different ways of creating a User programme:

- At the end of an Automatic programme or Special application, save it as a User programme.
- After running a programme with a set duration, save it.

Then name the programme.

### Creating a User programme

- Select **User programmes** .

- Select **Create programme**.

You can now specify the settings for the first cooking stage.

Follow the instructions in the display:

- Select and confirm the desired settings.
- Select **Complete cooking stage**.

All settings for the first cooking stage have now been set.

You can add more cooking stages, for example, if you want to add another cooking function to follow on from the first.

- If additional cooking stages are required, select **Add cooking stage** and proceed as you did for the first cooking stage.

If you want to check the settings or to change them at a later date, select the cooking stage in question.

- When you have finished setting all the cooking stages, select **Save**.
- Enter the programme name.
- Select **✓**.

A message will appear in the display confirming that the new name has been saved.

- Confirm with **OK**.

You can start the saved programme immediately, delay the start or change the cooking stages.

## Starting a User programme

- Place the food in the oven.
- Select User programmes .
- Select the required programme.
- Select Allow.

Depending on the programme settings, the following menu options will appear in the display:

- Start now  
The programme will start immediately. The oven heating will switch on immediately.
  - Finish at  
Specify the time at which the programme should finish. The oven heating will switch off automatically at the time you have set.
  - Start at  
Specify the time at which you want the programme to start. The oven heating will switch on automatically at the time you have set.
  - Show cooking stages  
A summary of your settings will appear in the display.
- Select the required menu option.
- The programme selected will begin straight away or at the time set.
- At the end of the programme, select the  sensor.

## Changing cooking stages

Cooking stages in an Automatic programme that you have renamed as a User programme cannot be changed.

- Select User programmes .
- Select the programme you want to change.
- Select Change programme.
- Select the cooking stage that you want to change or Add cooking stage to add another cooking stage.
- Select and confirm the desired settings.
- If you want to start the modified programme without changing it, select Start programme.
- Select Save when you have changed all the settings.

A message will appear in the display confirming that the new name has been saved.



- Confirm with OK.

The saved programme has been changed and you can start it immediately or delay the start.

# User programmes

---

## Changing a name

- Select User programmes .
- Select the programme you want to change.
- Select Change name.
- Change the programme name.
- Select .

A message will appear in the display confirming that the new name has been saved.

- Confirm with *OK*.

The programme has been renamed.

## Deleting User programmes

- Select User programmes .
- Select the programme you want to delete.
- Select Delete programme.
- Confirm the request with *Yes*.

The programme is deleted.

Go to Other  | Settings  | Factory default | User programmes **to delete all User programmes at the same time.**

 Risk of injury caused by hot surfaces.

The steam oven gets hot during operation. You could burn yourself on the oven compartment, shelf runners or accessories.

Allow the oven compartment, shelf runners and accessories to cool before cleaning.

 Risk of injury due to electric shock.

The steam from a steam cleaning appliance could reach electrical components and cause a short circuit.

Never use a steam cleaner for cleaning.

All surfaces could be discoloured or damaged if unsuitable cleaning agents are used.

All surfaces of this appliance are susceptible to scratching. Scratches on glass surfaces could cause a breakage in certain circumstances.

Only use cleaning agents designed for domestic use.

Remove all cleaning agent residues immediately.

Do not use cleaning agents or washing-up liquids containing aliphatic hydrocarbons as these could cause the seals to swell.

Stubborn soiling could damage the steam oven in certain circumstances.

Once the oven has cooled, clean the oven compartment, the inside of the door and the door seal. Waiting too long can make cleaning unnecessarily difficult and in some cases impossible.

Operating a damaged appliance can result in microwave leakage and present a hazard to the user.

Check the door and door seal for any sign of damage. If any damage is noticed, the oven should not be used again with microwave functions until the fault has been rectified by a service technician.

- The appliance and accessories should be cleaned and dried thoroughly after each use.
- Leave the appliance door open until the oven interior is completely dry.

**Useful tip:** If the steam oven is not going to be used for a longer period of time, it should be thoroughly cleaned and dried beforehand to prevent the build-up of odours and so on. Leave the door open afterwards.

# Cleaning and care

---

## Unsuitable cleaning agents

To avoid damaging the surfaces of your appliance, do not use:

- cleaning agents containing soda, alkalines, ammonia, acids or chlorides
- cleaning agents containing descaling agents
- abrasive cleaning agents, e.g. powder cleaners and cream cleaners
- solvent-based cleaning agents
- stainless steel cleaning agents
- dishwasher cleaner
- glass cleaning agents
- cleaning agents for ceramic cooktops
- hard, abrasive brushes or sponges, e.g. pot scourers, brushes or sponges which have been previously used with abrasive cleaning agents
- dirt erasers
- sharp metal scrapers
- steel wool or metal scourers
- stainless steel spiral pads
- spot cleaning with mechanical cleaning agents
- oven cleaners and sprays

## Cleaning the steam oven front

- Clean the appliance front with a clean, soft sponge and a solution of warm water and washing-up liquid.
- After cleaning, wipe the surfaces dry using a soft cloth.

**Useful tip:** A clean, damp microfibre cloth without cleaning agent can also be used.

## Cleaning the oven compartment

The oven compartment, the door seal, the inside of the door and the drip channel should be cleaned and dried after each use.

- Remove:
  - condensate using a sponge or absorbent cloth,
  - light, greasy soiling with a sponge and a solution of washing-up liquid and hot water.
- After cleaning, wipe the surface with clean water to remove any cleaning agent residues.
- Then wipe the surfaces dry using a cloth.

## Cleaning the Automatic door opener

Ensure that the door opener does not become soiled with food residues.

- Wipe away soiling **immediately** with a clean sponge and a solution of washing-up liquid and hot water.
- After cleaning, wipe the surface with clean water to remove any cleaning agent residues.

## Cleaning the water container

- Take out the water container after each use involving steam.
- Remove the spill guard.
- Empty the water container.
- Rinse the water container by hand and then dry it to prevent limescale.
- Refit the spill guard on the water container. Make sure the spill guard engages correctly.

## Accessories

All accessories are dishwasher-safe.

## Cleaning the glass tray, rack and cooking containers

- Wash and dry the glass tray, rack and cooking containers after each use.
- Any bluish discolouration on the cooking containers can be removed with vinegar. Rinse afterwards with clean water.

# Cleaning and care

## Cleaning the shelf runners

The shelf runners are suitable for cleaning in a dishwasher.

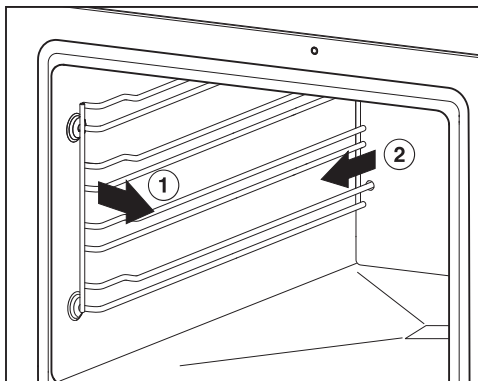

- Pull the runners out of the holder (1) at the front of the oven and then pull them out of the oven (2).
- The shelf runners can be washed in the dishwasher or by hand with a solution of warm water and a little washing-up liquid applied with a clean sponge or cloth.

**Refit** in the reverse order.

- Refit the shelf runners carefully.

If the shelf runners are not correctly inserted, there is no anti-tip protection.

The shelf runners are fitted in plastic bushings. Check the bushings for damage.

If the bushings are damaged, do not use any functions involving microwave power until the bushings have been replaced.

## Maintenance

The **Finish at** and **Start at** functions are not available in maintenance programmes.

## Descaling the steam oven

We recommend using Miele descaling tablets (see “Optional accessories”) to descale the appliance. These have been specially developed for use with Miele appliances to optimise the descaling process. Other descaling agents, which contain other acids besides citric acid and/or other undesirable substances, such as chlorides, could cause damage to the product. Moreover, the descaling result required could not be guaranteed if the descaling solution was not of the appropriate concentration.

Do not spill descaling agent onto metal surfaces. This can cause marks to appear.

However, should any descaling agent get onto these surfaces, wipe it away immediately.

The steam oven has to be descaled after a certain number of operating hours. When the time comes to descale it, the number of uses remaining lights up in the display. Only cooking processes that use steam are counted. The appliance will lock after the last remaining cooking process.

We recommend that you descale the appliance before it locks out.

During the descaling process, the water container must be rinsed out and refilled with fresh water.

- Switch the steam oven on and select Other  | Maintenance | Descale.

The message *Please wait* will appear on the display. The descaling process is being prepared. This may take several minutes. As soon as the appliance is ready, you will be prompted to fill the water container.

- Fill the water container with lukewarm fresh tap water up to the level marker  and drop 2 Miele descaling tablets in it.
- Wait until the descaling tablets have dissolved.
- Push the water container into the appliance.
- Confirm with *OK*.

The time remaining will appear in the display. The descaling process will now begin.

Do not switch the steam oven off during the descaling process, otherwise the whole process will have to be started from the beginning again.

During the course of the descaling process, the water container needs to be rinsed and filled with fresh water twice.

- Follow the instructions in the display.
- Confirm each with *OK*.

Once the time remaining has elapsed, *Finished* will appear in the display and a buzzer will sound.

- Switch the steam oven off.
- Remove the water container and remove the spill guard.
- Empty and dry the water container.
- Let the oven cavity cool down.
- Then dry the oven compartment.
- Leave the appliance door open until the oven interior is completely dry.

### Soak

Stubborn soiling can be soaked using this maintenance programme.

- Let the oven cavity cool down.
- Remove all accessories from the oven.
- Remove coarse soiling with a cloth.
- Fill the water container.
- Select Other  | Maintenance | Soak.

The soaking process takes approx. 10 minutes.

## Problem solving guide

---

With the help of the following guide, minor faults in the performance of the appliance, some of which may result from incorrect operation, can be remedied without contacting Miele. This will save you time and money because you won't need a service call.



Please note that a call-out charge will be applied to unnecessary service visits where the problem could have been rectified as described in these operating instructions.

Problem	Possible cause and remedy
<b>You cannot switch the appliance on.</b>	<p>The circuit breaker has tripped.</p> <ul style="list-style-type: none"><li>■ Reset the circuit breaker in the mains fuse box (see data plate for minimum fuse rating).</li></ul> <hr/> <p>There may be a technical fault.</p> <ul style="list-style-type: none"><li>■ Disconnect the appliance from the mains connection for approximately 1 minute by:<ul style="list-style-type: none"><li>– switching off at the wall socket and withdrawing the plug, or</li><li>– switching off the mains circuit breaker or residual current device.</li></ul></li><li>■ If, after switching the circuit breaker or residual current device back on, the steam oven will still not switch on, contact a qualified electrician or Miele.</li></ul>
<b>The oven does not heat up.</b>	<p>Demo mode is active. The steam oven can be operated, however the heating elements will not work.</p> <ul style="list-style-type: none"><li>■ Deactivate Demo mode (see “Settings - Showroom programme”).</li></ul> <hr/> <p>The oven cavity has been warmed up by a warming drawer in operation underneath it.</p> <ul style="list-style-type: none"><li>■ Open the door and let the oven cool down.</li></ul>



## Problem solving guide

Problem	Possible cause and remedy
<p><b>The sensors do not respond.</b></p>	<p>You have selected the <b>Display   QuickTouch   Off</b> setting. Therefore, when the steam oven is switched off, the sensors do not respond.</p> <ul style="list-style-type: none"> <li>■ As soon as the steam oven is switched on, the sensors will respond. If you want the sensors to always respond even when the steam oven is switched off, select the <b>Display   QuickTouch   On</b> setting.</li> </ul>
	<p>The steam oven is not connected to the power supply.</p> <ul style="list-style-type: none"> <li>■ Check that the steam oven plug is correctly inserted into the socket.</li> <li>■ Check if the circuit breaker has tripped. Contact a qualified electrician or Miele.</li> </ul>
	<p>There is a fault with the control unit.</p> <ul style="list-style-type: none"> <li>■ Touch and hold the <b>On/Off</b> (ⓘ) sensor until the display switches off and the steam oven restarts.</li> </ul>
<p><b>The fan can still be heard after the appliance has been switched off.</b></p>	<p>The fan is still running. The appliance is fitted with a fan which removes steam from the oven. The fan will continue to run for a while after the appliance has been switched off. It will switch itself off automatically after a while.</p>
<p><b>A humming sound can be heard after switching on the appliance, during operation and after switching off the appliance.</b></p>	<p>This is not a fault. It is made by water being pumped through the system.</p>
<p><b>After moving house, the appliance no longer switches from the heating-up phase to the cooking phase.</b></p>	<p>Altitude affects the boiling point of water. If you move house, the appliance will need to be reset for the new altitude if this differs from the old one by more than 300 m.</p> <ul style="list-style-type: none"> <li>■ To adjust the boiling temperature, you need to descale the steam oven (see “Cleaning and care – Descaling the steam oven”).</li> </ul>

## Problem solving guide

Problem	Possible cause and remedy
<p><b>During operation an unusually large amount of steam escapes or steam escapes from parts of the steam oven where it does not usually.</b></p>	<p>The door is not properly closed.</p> <ul style="list-style-type: none"> <li>■ Close the door.</li> </ul>
	<p>The door seal is not correctly fitted.</p> <ul style="list-style-type: none"> <li>■ If necessary, press it in all the way round the door to make sure it is fitted evenly.</li> </ul>
	<p>The door seal is damaged, e.g. cracked.</p> <p>The door seal needs to be replaced.</p> <ul style="list-style-type: none"> <li>■ Call Miele.</li> <li>■ Do not use any microwave functions until the door seal has been replaced.</li> </ul>
<p><b>A whistling sound is heard when the appliance is switched on again.</b></p>	<p>When the door is closed, the pressure has to equalise, which can cause a whistling sound. This is not a fault.</p>
<p><b>The <small>Start at and Finish at</small> functions are not available.</b></p>	<p>The temperature in the oven compartment is too high, e.g. after a programme has finished.</p> <ul style="list-style-type: none"> <li>■ Open the door and let the oven cool down.</li> </ul>
	<p>These functions are not generally available in maintenance programmes.</p>
<p><b>After long cooking cycles with microwave power , there are high levels of moisture in the cavity.</b></p>	<p>The steam oven with microwave is a fully fledged steam oven. The cavity is therefore completely steam-tight. In contrast, a conventional microwave oven is not air-tight. As a result of the steam-tight cavity, during long cooking cycles with microwave power , condensate will develop on the side walls and the inner door panel. The quantity of condensate depends on the cooking duration and the level of moisture in the food.</p>

## Problem solving guide

Problem	Possible cause and remedy
<p><b>The food is not sufficiently heated or is not cooked at the end of a set duration when using the Microwave  function.</b></p>	<p>The oven was not restarted after interrupting a cooking programme.</p> <ul style="list-style-type: none"> <li>■ Restart the cooking programme to ensure the food is heated or cooked properly.</li> </ul> <p>When cooking or heating with microwave power, the duration set was too short.</p> <ul style="list-style-type: none"> <li>■ Check that the correct duration is selected for the microwave power level. The lower the microwave power level, the longer the cooking duration.</li> </ul> <p>With a very small amount of food, the steam oven automatically reduces the power level to suit the actual amount of food as a safety precaution. The display still shows the previously set initial power level.</p> <ul style="list-style-type: none"> <li>■ Restart the programme with a lower microwave power level to ensure the food is heated or cooked properly.</li> </ul>
<p><b>Food has cooled down too quickly after being heated or cooked using the Microwave  function.</b></p>	<p>When cooked by microwaves, food begins to cook from the outside first, the inside of the food relying on the slower conduction of heat. If food is cooked at a high microwave power level, it is possible that the heat may not have reached the centre of the food, so it is hot on the outside but cold in the centre. During the standing time, the heat is transferred to the centre of the food.</p> <ul style="list-style-type: none"> <li>■ When reheating food with different densities, such as with menu cooking, it is sensible to start with a low microwave power level and select a longer reheating duration.</li> </ul>
<p><b>Less than half of the popcorn has popped when using the Popcorn  function.</b></p>	<p>The oven interior was too warm and/or too damp.</p> <ul style="list-style-type: none"> <li>■ Allow the oven compartment to cool and/or dry it with a towel.</li> </ul> <p>The cooking duration was too short.</p> <ul style="list-style-type: none"> <li>■ Change the preset time. The maximum cooking duration that can be set is 4 minutes (see “Settings – Popcorn”).</li> </ul>
<p><b>The oven lighting doesn't come on.</b></p>	<p>The lamp needs to be replaced.</p> <ul style="list-style-type: none"> <li>■ Call Miele to have the lamp replaced.</li> </ul>

# Problem solving guide

---

Problem	Possible cause and remedy
F44	Communication fault. <ul style="list-style-type: none"><li>■ Switch the steam oven off and then back on again after a few minutes.</li><li>■ If the same message appears again, call Miele.</li></ul>
<b>F and other fault codes</b>	Technical fault. <ul style="list-style-type: none"><li>■ Switch the appliance off and call Miele.</li></ul>

Miele offers a range of useful accessories, as well as cleaning and conditioning products for your appliance.

These products can be ordered from the Miele online shop.

They can also be ordered directly from Miele (see end of this booklet for contact details).

### Containers

Miele offers a wide range of cooking containers. These have all been optimised in terms of functionality and dimensions for Miele appliances. Detailed information on each of our products can be found on the Miele website.

The cooking containers provided and the rack are **not** suitable for use with the Microwave  function.

- Perforated cooking containers in various sizes
- Solid cooking containers in various sizes

### Cleaning and care products

- Descaling tablets
- All purpose microfibre cloth for removing finger marks and light soiling

### Other

The rack is **not** suitable for use with the Microwave  function.

- Rack
- Glass tray

# Service

---

## Contact in case of fault

In the event of any faults which you cannot remedy yourself, please contact Miele.

Contact information for Miele can be found at the end of this booklet.

Please quote the model and serial number of your appliance when contacting Miele. This information can be found on the data plate.

The data plate is visible on the front frame of the oven, with the door fully open.

## Warranty

The manufacturer's warranty for this appliance is 2 years.

For further information, please refer to your warranty booklet.

## Safety instructions for installation

 Risk of damage from incorrect installation.  
Incorrect installation can cause damage to the steam oven.  
The steam oven must only be installed by a qualified person.

- ▶ The connection data (frequency and voltage) on the steam oven's data plate must correspond with those of the electricity supply in order to ensure that no damage can occur to the steam oven. Compare this data before connecting the appliance. If in any doubt, consult a qualified electrician.
- ▶ Multi-socket adapters and extension leads do not guarantee the required safety of the appliance (fire hazard). Do not use them to connect the steam oven to the power supply.
- ▶ The socket and on-off switch should be easily accessible after the steam oven has been installed.
- ▶ The steam oven must be positioned so that you can see the contents of a cooking container placed on the top shelf level. Otherwise there is a risk of injuries or spillages of hot food.

# Installation

## Building-in dimensions

All dimensions are given in mm.

### Installation in a tall unit

The furniture housing unit must not have a back panel fitted behind the building-in niche.

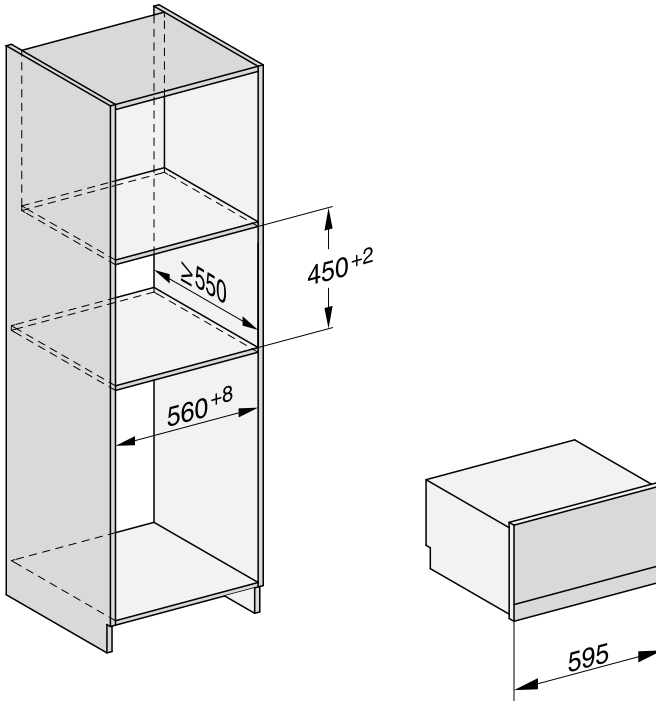

## Installation in a base unit

The furniture housing unit must not have a back panel fitted behind the building-in niche.

If the steam oven is to be installed in a base unit underneath an electric or induction cooktop, please also observe the installation instructions for the cooktop as well as the building-in height required for the cooktop.

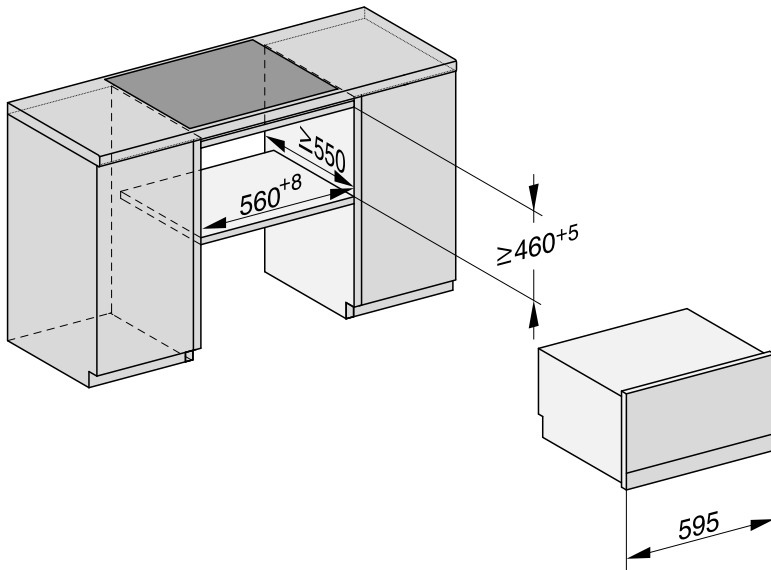

# Installation

## Side view

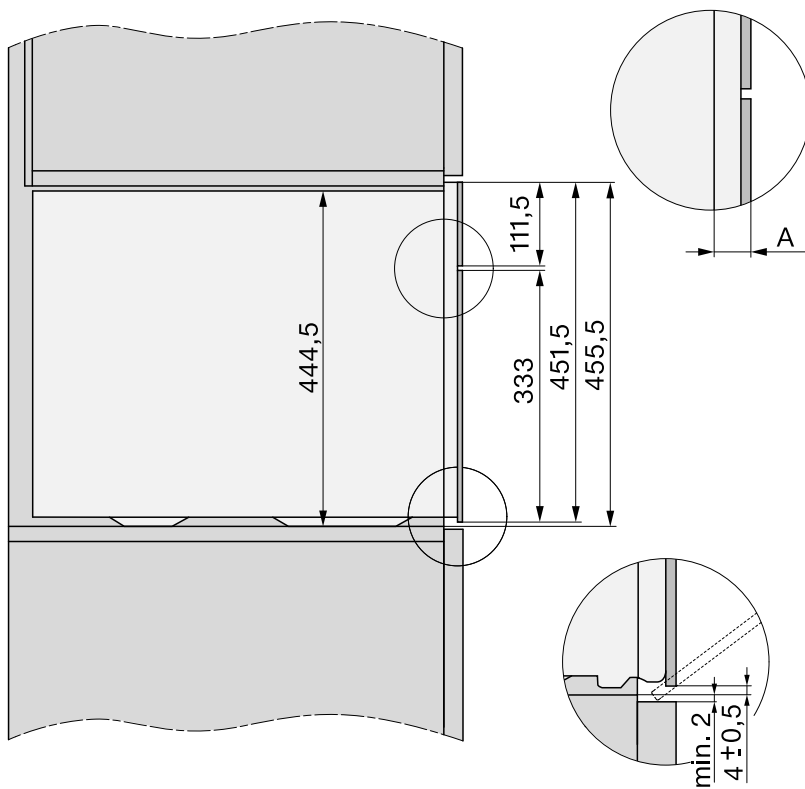

- A** Glass front: 22 mm  
Metal front: 23.3 mm

## Connection and ventilation

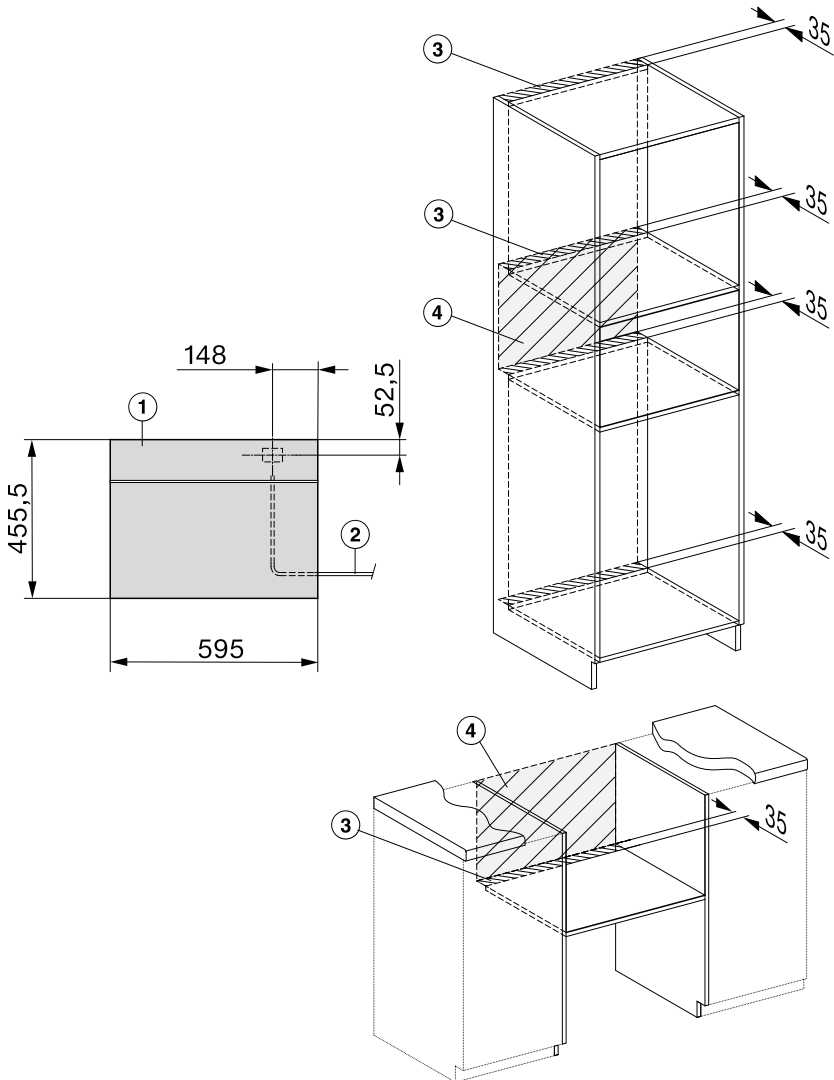

- ① Front view
- ② Mains connection cable, L = 2000 mm
- ③ Ventilation cut-out, min. 180 cm<sup>2</sup>
- ④ No connections permitted in this area

# Installation

## Installing the steam oven

- Connect the mains connection cable to the appliance.

Risk of damage from incorrect transportation.

Lifting the steam oven by the door handle could cause damage to the door.

Use the handle cut-outs on the side of the casing to lift the appliance.

The steam generator may malfunction if the steam oven is not on a level surface.

The maximum deviation from the horizontal that can be tolerated is 2°.

- Push the steam oven into the housing unit and align it.  
When doing so, make sure that the mains connection cable does not get trapped or damaged.
- Open the door.

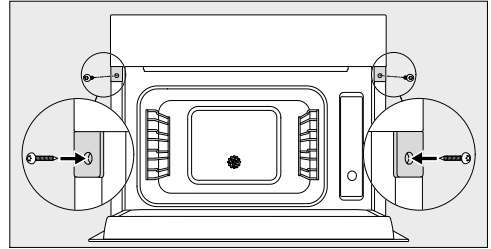

- Secure the steam oven to the side walls of the unit using the wood screws supplied (3.5 x 25 mm).
- Connect the appliance to the mains electricity supply.
- Check the appliance for correct function in accordance with the operating instructions.

## Electrical connection

We recommend that you connect the steam oven to the electricity supply using a suitable switched electrical socket. This simplifies servicing. The socket must be easily accessible after the steam oven has been installed.

 Risk of damage from incorrect connection.

Danger of injury! Miele cannot be held liable for unauthorised installation, maintenance and repair work as this can be dangerous to users.

Miele cannot be held liable for damage or injury (e.g. electric shock) caused by the lack of or inadequacy of an on-site earthing system.

If the plug is removed from the connection cable or if the cable is supplied without a plug, the steam oven must be connected to the electrical supply by a suitably qualified and competent electrician. If the socket is no longer accessible, or if a hard-wired connection is planned, an additional means of disconnection must be provided for all poles. Suitable means of disconnection include switches with an all-pole contact gap of at least 3 mm. These include miniature circuit breakers, fuses and relays. The connection data is given on the data plate. Please ensure this information matches the household mains electricity supply.

After installation, ensure that all electrical components are shielded and cannot be accessed by users.

## Total power output

See data plate.

## Connection data

The connection data is given on the data plate. Please ensure this information matches the household mains supply.

## Residual current device

For extra safety, it is advisable to protect the steam oven with a suitable residual current device (RCD) with a trip range of 30 mA.

## Replacing the mains connection cable

If replacing the mains connection cable, it must be replaced with a cable type H 05 VV-F, available from Miele.

## Disconnecting from the mains

 Risk of electric shock!

There is a risk of electric shock if the appliance is connected to the mains electricity supply during repair or service work.

After disconnection, ensure the appliance cannot be switched back on by mistake.



**Miele Australia Pty. Ltd.**

ACN 005 635 398

ABN 96 005 635 398

**Miele Head Office Melbourne:**Level 4, 141 Camberwell Road  
Hawthorn East, VIC 3123**Miele Experience Centre Doncaster:**1136/7 Doncaster Shopping Centre  
619 Doncaster Rd, Doncaster, VIC 3108**Miele Experience Centre South Melbourne:**206-210 Coventry Street  
South Melbourne, VIC 3205**Miele Experience Centre and Office Sydney:**3 Skyline Place  
Frenchs Forest, NSW 2086**Miele Experience Centre and Office Brisbane:**Tenancy 4C, 63 Skyring Terrace  
Newstead, QLD 4006**Miele Experience Centre Gold Coast:**131 Ferry Road  
Southport, QLD 4215**Miele Experience Centre and Office Adelaide:**83-85 Sir Donald Bradman Drive  
Hilton, SA 5033**Miele Experience Centre and Office Perth:**205-207 Stirling Highway  
Claremont, WA 6010**1300 464 353 (1300 4 MIELE)****[www.miele.com.au](http://www.miele.com.au)****Miele New Zealand Limited**

IRD 98 463 631

**Miele Experience Centre  
and Head Office Auckland:**8 College Hill  
Freemans Bay, Auckland 1011**Miele Experience Centre  
Wellington:**183 Featherston Street  
Wellington 6011**0800 464 353 (0800 4 MIELE)****[www.miele.co.nz](http://www.miele.co.nz)****Miele Global Headquarters  
Germany****Miele & Cie. KG**Carl-Miele-Straße 29  
33332 Gütersloh  
Federal Republic of Germany

DGM 7340, DGM 7440

en-AU, NZ

M.-Nr. 11 234 160 / 01