

Instruction Manual

HITACHI

Washing Machine

Fully Automatic

Model

SF-P130TCV



EN

Thank you for purchasing a Hitachi fully automatic washing machine.

- Please read this Instruction Manual carefully for proper operation of the machine.
- Please keep this Instruction Manual for future reference.

Contents

Preparation for use

Environmentally Friendly Waste Disposal	2
Hints and Tips for Eco-friendly Washing	2
Safety Instructions	3
Installation.....	5
■ Parts and Accessories	5
■ Control Panel and Display.....	6
■ Preparation Before Use.....	8

Operation

How to Use the Washing Machine	9
Program Overview.....	16
List of Programs	17
■ How to Customize the Program	20
In Case of Power Outage	23

Maintenance

Care and Maintenance	24
Troubleshooting	25
Error Codes.....	26
How to Install the Washing Machine	27
Customer Service	31
Specifications	31

For household use only

Environmentally Friendly Waste Disposal

Disposing of the packaging

The shipping package has protected your new washing machine on its way to your home. Please contribute to a better environment by disposing of packaging materials in an environmentally conscious manner.

Risk of choking!

Do not let children play with packaging and associated parts.

There is a risk of suffocating with plastic bags and collapsible boxes.

Disposing of your old appliance

Old appliances are not worthless rubbish. Environment-conscious recycling can reclaim them to valuable new materials.

Risk of death!

Unplug the power plug from appliances you are no longer using. Cut off the power cord and dispose of it with the plug.

If you wish to discard this product, contact your local authorities for the correct method of disposal.

Hints and Tips for Eco-friendly Washing

- Keep to the load limit of each program.
- This washing machine features power-saving operations with a built-in inverter controller which enables the machine to optimize operations according to the conditions of your clothes.
- Add detergent according to the degree of soiling, laundry size, and water hardness. Follow the detergent manufacturer's instructions regarding the amount of detergent to use.

Safety Instructions

This washing machine is designed for home use only.

Before operating the washing machine, please read these safety instructions carefully.

WARNING

Issues which could cause death or serious injury.

General safety

- Do not dismantle, repair or modify the washing machine.
→ This could cause malfunction, fire, electric shock or injury.
→ Contact your local service center for repairs.
- Do not put fire sources or anything inflammable in or near the washing machine (gas, diesel, petroleum, thinner, alcohol, or clothes stained with these substances).
→ This could cause an explosion or fire.
- Do not pour water on the washing machine during operation.
→ This could cause an electric shock.
- Do not climb on the washing machine. Do not place heavy object, drop any object or apply impact on the lid glass.
→ This could cause lid glass breakage. If any scratch or breakage is found on lid glass, stop using the washing machine and contact your local service center to request inspection and repair.
- Do not forcibly open the lid during operation:
Lid Lock Switch is designed to prevent from opening the lid during operation. This is because touching the washing tub while it is spinning may result in serious injury. If you can open the lid during operation, please stop using the Washing Machine immediately and refrain from touching the inside.
→ Contact your local service center for repair.
- This appliance is not intended for use by persons with reduced physical, sensory or mental capabilities, or lack of experience and knowledge (including children) unless they have been given supervision or instruction concerning use of the appliance by a person responsible for their safety.

Installation

- Do not install the washing machine in an extremely humid place, such as a bathroom or a place exposed to rain.
→ Risk of fire, electric shock, current leakage, corrosion or product damage.
- Do not install the washing machine on a board with castors or on an unstable surface.
→ This may cause injury or malfunction due to abnormal vibration.
- The washing machine must be grounded if you use a two-pin plug adapter on the three-pin plug.
→ Failing to do so could cause an electric shock, electronic substrate and electronic parts damage.
- Use a new water supply hose to connect the washing machine to the water tap.
- The opening must not be obstructed by carpeting if the washing machine is installed on a carpeted floor.

Power source and cord

- Do not insert or remove the power plug with wet hands.
→ This could cause an electric shock.
- Use the rated voltage. Do not connect other devices to the same outlet.
→ Using the washing machine and other electric appliances on the same outlet may cause the plug to overheat and result in fire.
- Clean off any dust on the power plug.
→ A dirty or dusty plug may cause a fire.
- Do not use an electric socket or outlet that is damaged or loose.
→ This could cause an electric shock, short circuit, or fire.
- Do not damage, cut, modify, bend, or fold the power cord.
→ This could damage the power cord and cause a fire or electric shock.
- Do not use an extension cord on the power cord.
→ This could cause an overheating or fire.
- If the power cord is damaged, it must be replaced by a service agent or repair shop authorized by the manufacturer to avoid risks.

Safety Instructions

Child safety

- Keep packaging out of reach of children and infants.
→ Danger of suffocation.
- Do not let children climb onto the washing machine or to get into the tub. Do not leave boxes or chairs near the washing machine that children could use to climb onto it.
→ This may cause injury.
- Children should be supervised to ensure that they do not play with the appliance.

CAUTION

Issues which could cause injury or damage property.

General safety

- If there is a water outage or if you are removing the water supply hose to reattach it, close the tap and press the Start/Pause button, then wait 40 seconds and slowly open the tap.
→ Air pressure from a large amount of air in the water pipes could damage the washing machine.
- Periodically check that the union nut on the water supply hose is tight.
→ A loose nut may cause a water leak.
- Remove the power plug from the outlet and close the water tap if you will not use the washing machine for a long time.

Use

- All packaging materials must be removed before using the washing machine.
→ This could cause malfunction or abnormal vibration.
- Check inside the tub before operating the washing machine.
→ Check that no pets or small animals are in the tub.
- Do not wash items through which water does not flow easily such as raincoats, wet suit, ski suits, sleeping bags, cushions, pillows, shoes, shower curtain.
→ The washing machine may not work properly, or it could cause injury or damage the washing machine.
- Do not fold and stack large items such as blankets together when washing them.
- Do not use a laundry net that is larger than 40cm on a side.
→ The clothes may become off balance and cause abnormal vibration during the spin cycle.
- Do not load laundry over the lower part of the liquid load balancer (dotted line).
→ Doing so could cause laundry to fly out of the tub during the spin cycle and damage the clothes or the washing machine, or cause a water leak.
- Always put detergent into the detergent dispenser when washing laundry.
- Do not use water hotter than 50°C.
- Do not open the lid without using the Lid Open Button.
→ This may cause the damage of lid and lid open button.
- Do not wash items together with coins, pins, or stones.
→ This may damage clothes or the washing machine, or cause a water leak.
Check inside pockets before washing.
- Do not press the control buttons with sharp pointed objects.
- Do not put heavy objects, liquid-filled containers or equipment which produces heat on the washing machine.
→ This may damage the washing machine or its top.

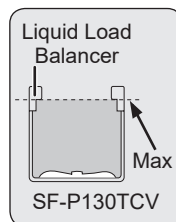

Care and maintenance

- If detergent, fabric softener or bleach spills on the surface of the machine, clean it up with a damp cloth immediately.
→ The plastic or steel parts of the washing machine may be damaged.
- Do not place equipment that produces heat near the washing machine.
→ This may cause deformation of the washing machine.

Parts and Accessories

Tub

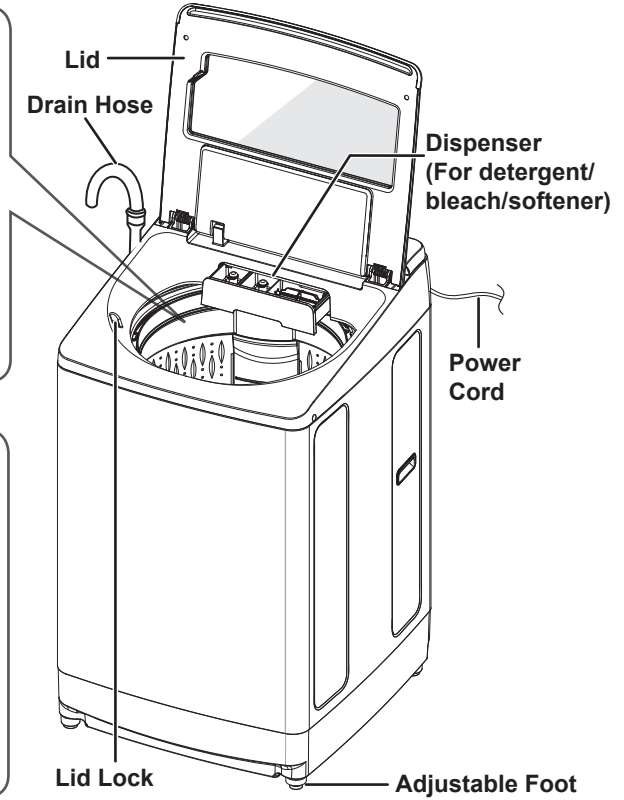
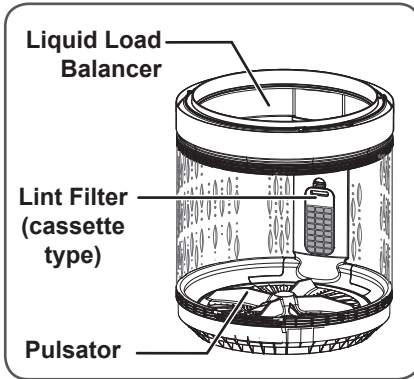

Dispenser

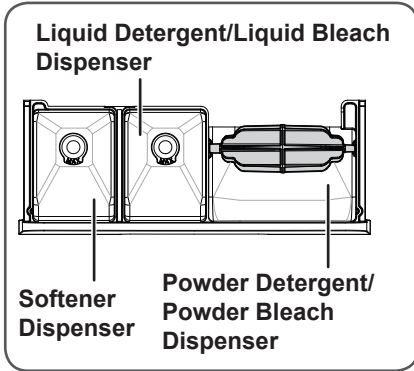

Accessories

<p>Water Supply Hose</p> <p>(2 sets)</p>	<p>U Shape Holder</p> <p>(1 piece)</p>	<p>Drain Hose Assembly and Hose Clamp</p> <p>(1 set)</p>	<p>Foot Caps</p> <p>(2 pieces)</p>	<p>Rat Guard</p> <p>(2 pieces)</p> <p>(1 set)</p>
--	--	--	------------------------------------	---

Optional accessories

Laundry Net



Refer to page 12
Part number PTSF-140JJS 001





Control Panel and Display

During Operation (lid closed)

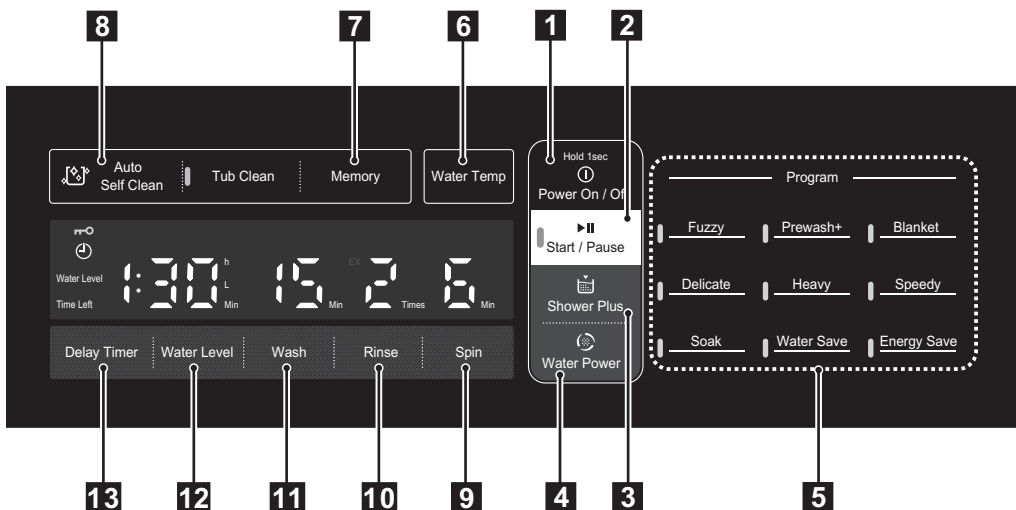
NOTES



- Directly touch the buttons on the Control Panel with your bare finger.
- If you find water drops, detergent or other foreign substances on the Glass Lid, please clean them up with a dry cloth.



<p>1 Power button</p> 	<p>Press this button to switch power on and off (when power on, please hold 1sec and display  HOLD is on). The washing machine automatically switches off when operations are finished. The washing machine also turns off automatically if it is not operated or no button is pressed for 10 minutes after the power has been turned on.</p>
<p>2 Start/Pause button</p> 	<p>Press this button to start or pause the operation. When the washing machine is paused for over twenty-four hour without any operations, it turns off automatically.</p>
<p>3 Shower Plus button</p> 	<p>To add the water shower during the operation, press this button. Extra amount of water supplied depends on load amount or program. If you want to cancel this option, press this button again. This function is available during the washing and normal rinsing processes. This button does not function if the water level has already reached at the highest level of each program.</p>
<p>4 Water Power button</p> 	<p>The strength of the water flow changes each time this button is pressed. Water flow strength is shown on the Water Level/Timer indicator. (0: normal, 1: strong, 2: stronger, -1: weak, -2: weaker) This function is available during the washing and normal rinsing processes.</p>
<p>5 Program button</p>	<p>Press this button to select the program. The program changes each time the button is pressed.</p>
<p>6 Water Temp button</p>	<p>Press this button to select the water temperature. The water temperature changes each time this button is pressed. (Warm → Hot → Cold)</p>

Control Panel and Display

During Operation (lid closed)

<p>7 Memory button</p> 	<p>To record your customized washing course, press this button for more than 3 seconds after selecting each detail such as water level, wash time, rinse time and spin time. From the next laundry, you can recall this memorized course just by pressing this button after turning the Washing Machine on.</p>
<p>8 Auto Self Clean button</p> 	<p>“Auto Self Clean” function automatically cleans both inner and outer tubs to keep the washing machine clean. This setting is switched off at the time of shipment from the factory. Once switched on, the “Auto Self Clean” function operates every time you wash your laundry.</p>
<p>9 Spin button</p>	<p>Press this button to change the spin time. The spin time can be set between 1 and 9 minutes.</p>
<p>10 Rinse button</p>	<p>Press this button to change the rinse time.</p>
<p>11 Wash button</p>	<p>Press this button to change the washing time. The washing time can be set between 3 to 24 minutes.</p>
<p>12 Water Level button</p>	<p>You can set the amount of Water each time you press the Water Level button.</p>
<p>13 Delay Timer button</p> 	<p>The delay time can be set between 3 and 12 hours. Lights in the Delay Timer mode. When this mode is on, Delay Timer button is lighted.</p>

Displays all cycle Information, remaining time and error codes.

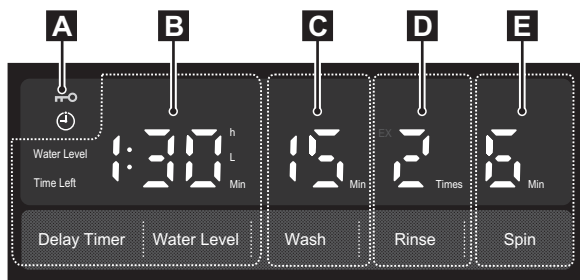

<p>A</p>	<p>Lid lock  : The Lid is locked when this symbol is lighted.</p>
<p>B</p>	<p>→ Adjust the “Water Level” of program (shown as ‘Water Level’) → Remaining time of the program (shown as ‘Time Left’)</p>
<p>C</p>	<p>Time of the Wash.</p>
<p>D</p>	<p>Time of the Rinse.</p>
<p>E</p>	<p>Time of the Spin.</p>

Preparation Before Use

Preparation of the laundry

- Remove foreign objects, if any (coins, safety pins, etc.). Service calls due to foreign objects found in the machine are not covered under the manufacturer's warranty.
- Put delicate clothes (knits, lingerie, etc.) in a net.
- Remove large lumps of lint, mud, sand, hair, and pet hair from laundry, if any.
- Tie strings and close fasteners, if applicable.



Sorting of the laundry

- Sort laundry according to the type of fabric and care label symbols (cottons, blended fabrics, synthetics, wool, hand washable items, etc.).
- Do not wash extremely small loads, such as only a pair of jeans.
→ This may cause abnormal vibration during the spin cycle.
- Separate colored and white items.

Risk of injury!

Do not wash the following items through which water does not flow easily, because doing so creates abnormal vibration during the spin cycle and could cause injury or malfunction.

- Waterproof items, such as a wet suit, ski suit, shower curtain, etc.
- Items with non-slip rubber backing such as door mats.
- Cushions, pillows, shoes, etc.

Detergents and additives

- Use an appropriate amount of detergent according to the detergent indicator of the washing machine.
The type and amount of detergent vary depend on the type of fabric, volume, load size, degree of soiling, and hardness of the water used.
Use less detergent if:
 - The load is small.
 - The laundry is not very dirty.
- Too much detergent can result in excess foam, which reduces rinse efficiency or may cause a water leak.
- Depending on the detergent brand, detergent may not dissolve completely in the detergent tray if the water pressure is low or the water is too cold.
→ Page 24: Care and Maintenance
- When using softeners or bleaches, follow the instructions on the package.

* If water pressure is unstable during operation, it may cause the water to remain in Detergent and Softener box.

How to Use the Washing Machine

1 Sort the laundry

- Sort the laundry according to the type of fabric, care label symbol, and degree of soiling.
→ Page 8: Preparation of the laundry
- Do not exceed the maximum load.
- Laundry shall not exceed this line otherwise laundry may jump out from the washing tub while spinning and it may cause damage.

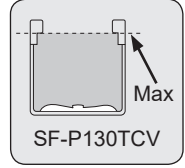

2 Press the Power button to turn on the power

- If no program is selected within 10 minutes, the washing machine automatically switches itself off.
Press the Power button again to turn on the power.

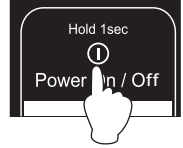

3 Select and adjust the program

- Select a program with the Program button.
→ Page 17: List of Programs
- You can change the combination or settings of wash, rinse, and spin operations by the Wash, Rinse, and Spin buttons.
- You can switch on the "Auto Self Clean" function by the Auto Self Clean button.
→ Page 11: How to use the "Auto Self Clean" function
→ Once switched on, the "Auto Self Clean" function operates every time you do your laundry.
To deactivate, press the same button again while the power is on.
- You can select the water temperature with the Water Temp button.
→ Page 14: How to use the Water Temp function

Set the operations

Select a function.

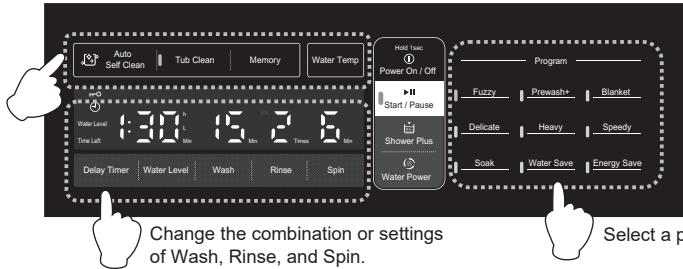

Change the combination or settings of Wash, Rinse, and Spin.

Select a program.

4 Press the Start/Pause button

- Before operation starts, the laundry is weighed. Then, the necessary amount of detergent and water shall be displayed.

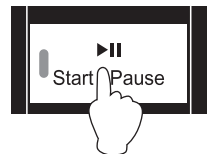

How to Use the Washing Machine

5

Put detergent into the detergent dispenser and close the lid

- Open the detergent dispenser, add the amount of detergent shown on the package, and then close the detergent dispenser.
- Since the required amount of detergent varies depending on the type of detergent, follow the instructions on the package of detergent.
- For liquid detergent, follow the instructions on the package and add it to the liquid detergent/liquid bleach dispenser.
- Add softener to the softener dispenser according to the instructions on the package of softener. Then, softener shall be added to the tub automatically before the final rinse.
- For liquid bleach, follow the instructions on the package and add it to the liquid detergent/liquid bleach dispenser.
- The speed that the lid closes may vary, depending on the temperature; however, this is not an abnormality.

Pausing a program:	Press the Start/Pause button. The washing machine will switch itself off if it is not restarted within 24 hours.
Adding clothes partway through a program:	Press the Start/Pause button to pause operation and add your clothes. The lid is locked while the tub is spinning, so wait until the tub stops completely and the lid lock is automatically released. After adding the clothes, close the lid and press the Start/Pause button to restart the operation. * Note: It is not recommended to add a large amount of clothes as the washing machine first measures the load size to determine optimum operation.
Adding water partway through a program:	Press the Shower Plus button to add water. To stop adding, press the same button again. If the water level is already at the maximum level, water cannot be added any more. * Note: This function cannot operate in the Tub Clean, Blanket and Water Save Programs.
Changing strength of water flow:	Press the Water Power button. You can repeatedly press the button to adjust the strength through five levels. * Note: This function operates in the Fuzzy, Prewash+, Delicate, Speedy, Soak and Water Save courses for washing and normal rinsing programs. Depending on the program, maximum/minimum water power you can change with this button is different. Also, when a load amount is large, changes of water strength might not always visibly distinctive.
Terminating a program:	Press the Start/Pause button, then press the Power button to turn off the power.

How to Use the Washing Machine

6 Take out the laundry (End of the program)

- The alarm sounds when a program ends.

The alarm can be deactivated or the sound can be changed in 5 types if the button of Water Level is pressed for at least 3 seconds.

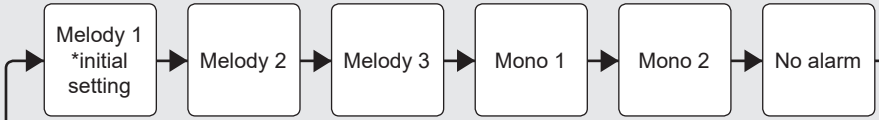

- The washing machine automatically switches off when the operations are finished. Open the lid and take out the laundry to dry.

How to use the “Auto Self Clean” function

- 1 Press the Power button to turn on the power.
- 2 Select a program.
- 3 Press the Auto Self Clean button.
- 4 Press the Start/Pause button.

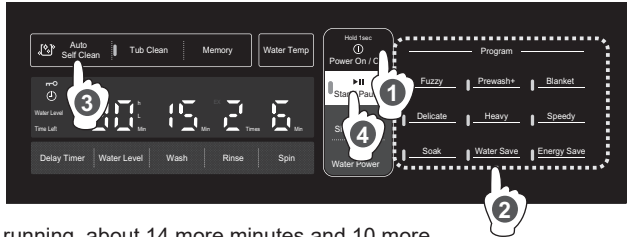

- When the “Auto Self Clean” function is running, about 14 more minutes and 10 more liters of water are needed.
- This setting is switched off at the time of shipment from the factory. Once activated, the “Auto Self Clean” function operates every time you do your laundry.
- Prior to the final spin cycle, the outside of the tub, the back side of the pulsator, and the inside of the outer tub are washed.
- To deactivate the “Auto Self Clean” function, press the Auto Self Clean button again while the power is on.

- The “Auto Self Clean” function runs just before spin cycle begins in each program.
- The “Auto Self Clean” function runs even when the washing machine has started operation from rinsing.
- The “Auto Self Clean” function cannot be set or cancelled during operation.
- The “Auto Self Clean” function is automatically cancelled when:
 - The spin time is manually set to 1 minute.
 - Spin-only operation is set.
 - No spinning is set.
- Depending on the type and degree of dirt, some dirt may not be washed with the “Auto Self Clean” function.
- If the washing machine is seldom used, some dirt may not be washed with the “Auto Self Clean” function.
- To clean the tub more completely, we recommend using the Tub Clean program along with the “Auto Self Clean” function.

- The “Auto Self Clean” function is deactivated when one of the following programs is selected.
 - Blanket
 - Tub Clean
- When the “Auto Self Clean” function is running, some water may flow out from the softener dispenser. This is the normal operation of the washing machine and does not indicate a malfunction.

How to Use the Washing Machine

How to use the Blanket program

① Prepare the laundry.

- Fold large items, such as quilts or blankets, as follows.
They should not be taller than 30cm after they are folded.

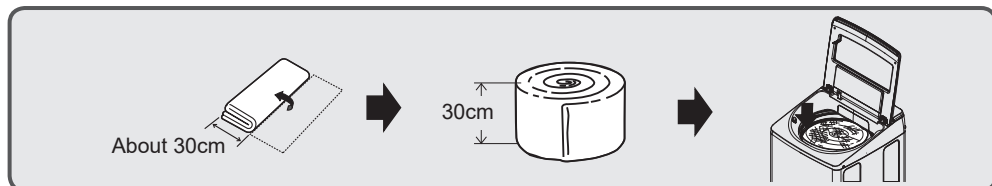

If it exceeds 30cm, use a laundry net, which is sold separately.
(Laundry net: Product number PTSF-140JJS 001)



② Press the Power button to turn on the power.

③ Select the Blanket program.

④ Press the Start/Pause button.

⑤ Add detergent and close the lid.

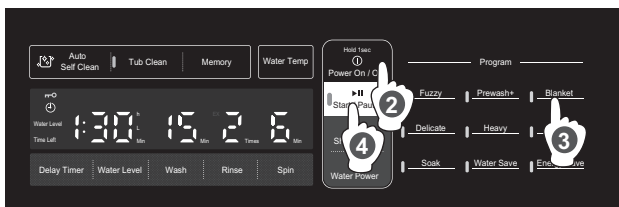

Water temperature setting cannot be changed when this program is selected.

Items you can wash with the Blanket program are as follows:

- Washable quilts

Blanket can be washed without laundry net when its size is:

150cm x 200cm or smaller, and less than 1.5 kg

Blanket should be washed in the laundry net when its size is:

Bigger than 150cm x 200cm up to 174cm x 225cm, heavier than 1.5kg up to 2.0kg

(Laundry net: Product number PTSF-140JJS 001)

- Washable blankets

Up to 3kg of synthetic blankets that are labeled as hand washable.

– For electric blankets, follow the instructions for the electric blanket.

- Other washable items

Mattress pads labeled as hand washable.

■ Do not fold and stack large items together (such as sheets) when washing them.

→ The clothes may become off balance and cause abnormal vibration during the spin cycle.

How to Use the Washing Machine

How to use the Tub Clean program

- Use this program separately from other washing programs. (Do not put laundry into the tub.)
 - 1 Press the Power button to turn on the power.
 - 2 Select the Tub Clean program.
 - The Tub Clean program can be set to 3 or 11 hours. At first, "11 hours" is set. Press the Program button again to set "3 hours".
 - 3 Close the lid, and press the Start/Pause button. The washing machine starts pouring water into the tub. (Close the lid when C3 is displayed)
 - 4 Press the Start/Pause button and open the lid, add tub cleaner to the tub by following the instruction given on its package. (Liquid peroxide-based bleach is also effective as a tub cleaner. Since the required amount of bleach varies depending on the type, follow the instructions given on its package.)
 - Water is added to the maximum level to wash away invisible dirt from both outer and inner tubs. Then, normal rinse operation will be performed twice to flush out any remaining dirt and tub cleaner.
-

How to use the Delay Timer

- 1 Press the Power button to turn on the power.
 - 2 Select a program.
 - 3 Press the Delay Timer button and select the time to finish washing. Each press of the button starting from 3 hours to 12 hours later.
 - 4 Press the Start/Pause button.
 - 5 Add detergent and close the lid. The power turns off after a short time.
 - 6 Operations finish at the set time.
- The Delay Timer is unavailable for the Blanket and Tub Clean programs.
 - To change the setting, press the Power button and do the settings again.
 - If there is a power outage while the timer is set, the timer setting is cancelled. If this happens, press the Power button again and reset the timer.
 - To prevent your laundry from wrinkling, take them out from the Washing Machine to dry once the operation is completed.

How to Use the Washing Machine

How to use the Prewash+ program

■ You can wash your heavily soiled laundry first, then add the regular laundry to wash off all together. A guidance Beep sound is generated about 20 minutes after starting the operation, put additional laundry and detergent at this time.

- * Recommended amount of heavily soiled laundry is less than 2kg.
- Additional amount of regular laundry should be less than 8kg.

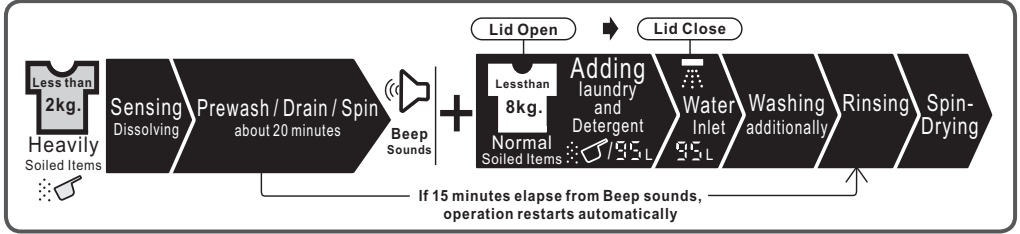

Operation:

- 1 Press the Power button to turn on the power.
- 2 Select the Prewash+ program.
- 3 Press the Start/Pause button.
- 4 Put the detergent and close the lid.
- 5 When the Beep sounds, open the lid to add the Laundry and Detergent, then close the lid.

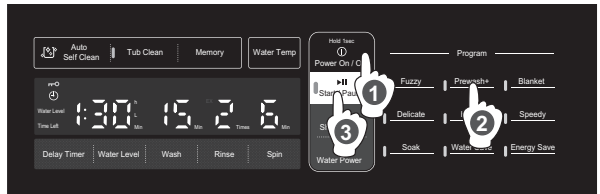

Others:

- Please put additional laundry and detergent within 15 minutes after the Beep sounds. If 15 minutes elapse from Beep sounds, operation restarts automatically.
- In this case, rinsing starts without adding washing cycle.

How to set the Water Temperature

Operation:

- 1 Press the Power button to turn on the power.
- 2 Select your desired program.
- 3 Set the water temperature by pressing the Water Temp button.
- 4 Press the Start/Pause button to start your selected program.

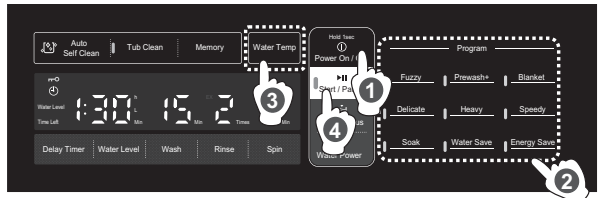

Others:

We recommend to use warm/hot/cold water for the following cases:

- Warm water: Default water temperature setting is warm. When your laundry is heavily soiled, warm water washing is recommended. Warm water can also be used for colorfast fabrics, dark fabrics, white and colored synthetics, permanent press clothes or woollen items.
- Hot Water: To wash soiled white or colorfast cottons, linens, permanent press synthetics, we recommend to use hot water.
- Cold Water: This is suitable for lightly soiled or normally soiled items.
- The glass lid and the display screen may become foggy with this program, but this is not failure. The fog disappears in approximately 24 hours and it does not affect the operation.

■ How to select water temperature

→ The water temperature can be changed manually with every program (For some programs, the most suitable temperature is already fixed).

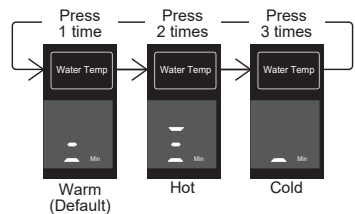

How to Use the Washing Machine

Below settings are used for testing of Australian Standards.

Water & Energy efficiency labels are therefore based on the test result with the below settings.

WARM WASH setting

1. Close the lid of Washing Machine.
2. Press the “Power” button to switch on.
3. Press the “Water Save” button.
4. Press the “Water Temp” button until the “Warm” signal is illuminated.
(Please refer to the below image for “Warm” signal).
5. Press the “Water Level” button to set the water level to 82.
6. Press the “Wash” button to set the wash time to 99 mins.
7. Press the “Rinse” button to select number of Rinse 2.
8. Press the “Spin” button to set the spin time to 9 mins.
9. Press the “Water Power” button to select the waterpower until “1” is displayed.
10. Press the “Start” button.



COLD WASH setting

1. Close the lid of Washing Machine.
2. Press the “Power” button to switch on.
3. Press the “Water Save” button.
4. Press the “Water Temp” button until the “Cold” signal is illuminated.
(Please refer to the below image for “Cold” signal).
5. Press the “Water Level” button to set the water level to 82.
6. Press the “Wash” button to set the wash time to 99 mins.
7. Press the “Rinse” button to select number of Rinse 2.
8. Press the “Spin” button to set the spin time to 9 mins.
9. Press the “Water Power” button to select the waterpower until “1” is displayed.
10. Press the “Start” button.

Note 1: This washing machine has wash cycles that are designed to use less water.

Low-sudsing detergent is recommended to use.

Note 2: Water pressure during testing is 350 kPa.

Note 3: The start of washing operation is defined to begin at the “end of the hot water fill” for correct determination of maximum bath temperature measurement.

Note 4: The program used for testing is the one recommended for a normally soiled cotton load.

How to select “Warm” / “Cold”

→ Water temperature can be changed manually as the right image shows.

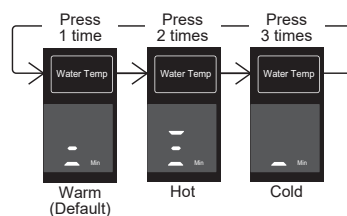

How to Use the Washing Machine

■ How to check the water temperature setting .

→ Press the  button during the operation.

Then, the water temperature setting shall be displayed for 3 seconds.

→ Once the program starts, the water temperature cannot be changed any more.

Program Overview

Program	Type of Laundry / Notes	Model / Max Load
		P130TCV
Fuzzy	For daily washing of cotton and linen items such as shirts, underwear, towels, bed linen and table linen.	13 kg
Prewash+	You can wash your heavily soiled laundry first, then add the regular laundry to wash off all together at a time.	10 kg
Delicate	This is a gentle wash program for delicate items such as lingerie and thin lace curtains.	6.5 kg
Speedy	This program lets you wash small loads of lightly soiled clothes and small items such as underwear.	6.5 kg
Soak	For washable large items and heavily soiled durable clothes.	10.4 kg
Blanket	For washable large items such as duvets, blankets, bedspreads, etc.	3 kg
Energy Save	This program provides an Eco operation by saving energy while assuring the same washing performance as the Fuzzy program.	13 kg
Water Save	This program provides an Eco operation by saving water while assuring the same washing performance as the Fuzzy program.	13 kg
Heavy	Select this program to wash heavily soiled durable clothes (jeans, sportswear, etc.)	13 kg

List of Programs

: Default settings

: Changeable settings (via corresponding button)

Program		Fuzzy	Prewash+		Delicate
			Pre	Add	
Maximum load	P130TCV	13 kg	2 kg	8 kg	6.5 kg
Amount of water	P130TCV	33 to 99 L (adjusted automatically)	33 to 68 L	90 L	61 L
		33 to 99 L		-	47 to 86 L
Wash		15 min	45 min		6 min
		3, 9, 12, 15, 18, 24 min, or none	-		-
Rinse		Spin Shower Rinse 2 times + Normal Rinse 1 time (In case of laundry exceeds 80%, the process will be Spin Shower Rinse 1 time and Normal Rinse 1 time.)	Normal Rinse 2 times		Normal Rinse 1 time
		Each time you press the Rinse button, the setting changes in sequence from Normal Rinse 2 times, Normal Rinse 3 times, Normal Rinse 1 time, or none	Each time you press the Rinse button, the setting changes in sequence from Normal Rinse 1 time, Normal Rinse 2 times, Normal Rinse 3 times, or none		
Spin	Time	6 min			3 min
		1, 3, 6, 9 min, or none			1, 3, 6, 9 min, or none
Required time (guide)	P130TCV	46 to 79 min	63 to 99 min		35 min

Program		Speedy	Soak				Blanket
			0.5 hrs	1 hrs	3 hrs	5 hrs	
Maximum load	P130TCV	7 kg	10.4 kg				3 kg
Amount of water	P130TCV	54 L	33 to 99 L (adjusted automatically)				103 L
		33 to 86 L	33 to 99 L				86 to 103 L
Wash		3 min	30 min	60 min	180 min	300 min	25 min
		3, 9, 12, 15, 18, 24 min, or none	-	-	-	-	-
Rinse		Normal Rinse 1 time	Normal Rinse 2 times				Normal Rinse 2 times
		Each time you press the Rinse button, the setting changes in sequence from Normal Rinse 1 time, Normal Rinse 2 times, Normal Rinse 3 times, or none	Each time you press the Rinse button, the setting changes in sequence from Normal Rinse 2 times, Normal Rinse 3 times, Normal Rinse 1 time, or none				-
Spin	Time	3 min	6 min				9 min
		1, 3, 6, 9 min, or none	1, 3, 6, 9 min, or none				
Required time (guide)	P130TCV	31 min	70 to 83 min	100 to 113 min	220 to 233 min	340 to 353 min	77 min

List of Programs



: Default settings

: Changeable settings (via corresponding button)

Program		Energy Save	Water Save	Heavy
Maximum load	P130TCV	13 kg	13 kg	13 kg
Amount of water	P130TCV	33 to 99 L (adjusted automatically)	33 to 94 L (adjusted automatically)	33 to 99 L (adjusted automatically)
		33 to 99 L	33 to 94 L	33 to 99 L
Wash		48 min	15 min	18 min
		-	3, 9, 12, 15, 18, 24, 99 min, or none	12, 15, 18, 21, 24 min, or none
Rinse		Spin Shower Rinse 2 times + Normal Rinse 1 time (In case of laundry exceeds 80%, the process will be Spin Shower Rinse 1 time and Normal Rinse 1 time.)	Normal Rinse 2 times	Spin Shower Rinse 2 times + Normal Rinse 1 time (In case of laundry exceeds 80%, the process will be Spin Shower Rinse 1 time and Normal Rinse 1 time.)
		-	Each time you press the Rinse button, the setting changes in sequence from Normal Rinse 2 times, Normal Rinse 3 times, Normal Rinse 1 time, or none	
Spin	Time	5 min	6 min	6 min
		-	1, 3, 6, 9 min, or none	
Required time (guide)	P130TCV	83 to 100 min	42 to 153 min	52 to 78 min

List of Programs

- The wash time and the spin time may change during the program depending on the weight and type of laundry being washed.
- The displayed times are guidelines. More time may be required depending on the water pressure and the type of laundry.
- Programs cannot be changed once they are started. To change them, turn the power off and then on again to re-select a program.
- When the “Auto Self Clean” function is running, about 14 more minutes and 10 more liters of water are needed.
- Spin Shower Rinse* is used in the Fuzzy and Energy Save programs to enhance water-saving performance without compromising the efficiency of rinsing.
* Spin Shower Rinse: A powerful shower and centrifugal force to rinse the detergent more effectively.
- The clear part of the lid and control panel may become foggy or may form dew on the edge of lid if you use hot water to wash your laundry; however, this is not an abnormality. Wipe it off after washing your laundry.
- It has the potential not to be enough for max load according to the kind of clothes.
- Even if you set the delay timer, it may start soon according to the required time of the program.
- Water flow is adjusted automatically according to the amount of load and water level. When loads are heavy and water level is high, water flow is adjusted at slower rate to maintain the performance of washer.
- Amount of detergent is indicated according to following table as a guide.



Load (guide) 	Water Level 	Amount of detergent 
8~13 kg	88~99 L	72 g
4~7 kg	68~82 L	46~55 g
0~3 kg	33~61 L	22~41 g

(SF-P130TCV)

* The amount of detergent is based on a type of “20-gram per 30-liter”.

Since the required amount of detergent varies depending on the type of detergent, follow the instructions on the package of detergent.

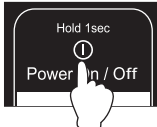
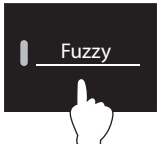
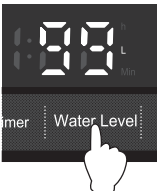
How to Customize the Program

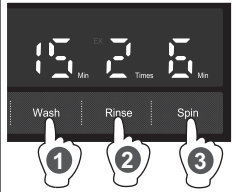
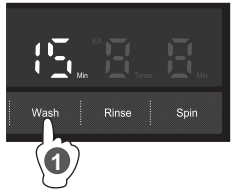
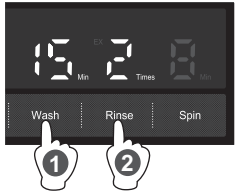
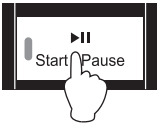
If you want...	To customize the wash program	To reuse the wash water and separate your laundry	To not spin the laundry because you are worried about wrinkles	
Operations	Wash → Rinse → Spin	Wash only	Wash → Rinse	
Setting method				
1.		Turn on the power.		
2.		Select the Fuzzy program.		
3.		Set the amount of water. If you do not set the amount of water, it is set automatically based on the weight of the laundry.		
4.	 <p>Set the operations</p>	 <p>① Set the wash time with the Wash button.</p> <p>② Set the number and type of rinses with the Rinse button.</p> <p>③ Set the spin time with the Spin button.</p>	 <p>① Set the wash time with the Wash button.</p> <p>② Set the number and type of rinses with the Rinse button.</p>	 <p>① Set the wash time with the Wash button.</p> <p>② Set the number and type of rinses with the Rinse button.</p>
5.		Press the Start/Pause button to start.		
Remarks	Operates according to the wash, rinse, and spin settings.	Stops while the wash water is still in the tub.	Stops while the rinse water is still in the tub.	

How to Customize the Program

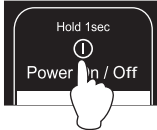
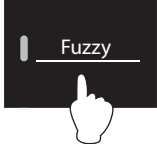
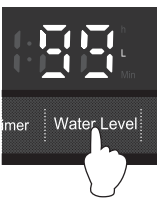
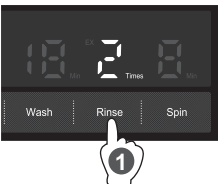
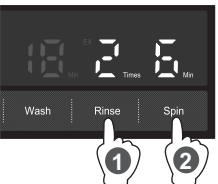
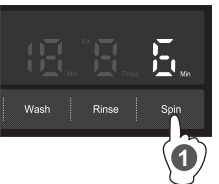
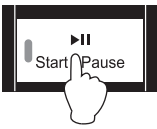
If you want...	To rinse only	To rinse and spin	To drain and spin
Operations	Rinse only	Rinse ⇨ Spin	Drain ⇨ Spin
Setting method			
1.	 <p>Turn on the power.</p>		
2.	 <p>Select the Fuzzy program.</p>		
3.	 <p>Set the amount of water. If the amount of water is not set, then maximum water level is used.</p>		Cannot be used.
4.	 <p>① Set the number and type of rinses with the Rinse button.</p>	 <p>① Set the number and type of rinses with the Rinse button. ② Set the spin time with the Spin button.</p>	 <p>① Set the spin time with the Spin button.</p>
5.	 <p>Press the Start/Pause button to start.</p>		
Remarks	Drains water and spins before rinsing. Stops while the rinse water is still in the tub.	Drains water and spins before rinsing.	Drains water and spins.

How to Customize the Program

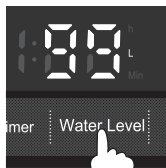

- Press the Water Level button until your desired setting of wash, rinse and spin are displayed.
If the indicator is not lit, that operation is not performed.

SF-P130TCV

- You can set the amount of water each time you press the Water Level button in a range from 33 to 99 L.

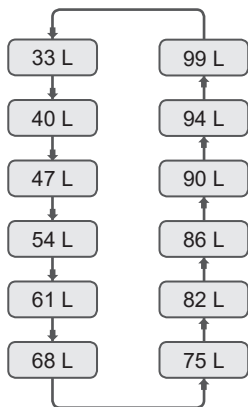

How to Customize the Program

- You can set the wash time each time you press the Wash button in a range from 3 to 24 minutes and no washing.

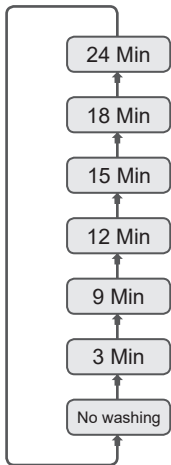
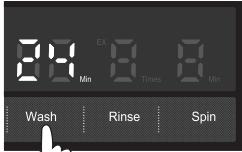

- You can set the number and type of rinses by pressing the Rinse button. Each time you press the Rinse button the setting changes in sequence, from Normal Rinse 2 times, Normal Rinse 1 time, no rinsing, Normal Rinse 3 times.

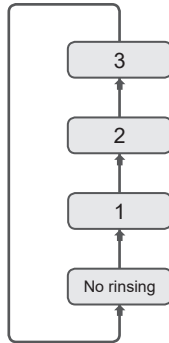

- You can set the spin time each time you press the Spin button in a range of 1 to 9 minutes and no spinning.

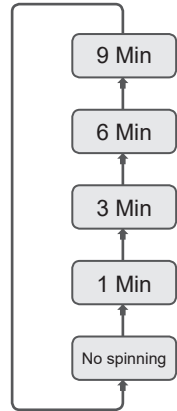
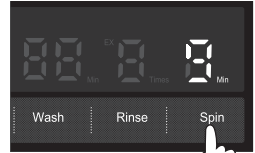

In Case of Power Outage

If there is a power outage

The washing machine is equipped with a restart function.

If a power outage occurs while the washing machine is operating, the cycle (i.e., wash, rinse, or spin) at that time is saved, and when the power is restored, automatically restart from the interrupted cycle.

If there is a power outage during the spin cycle, the lid is locked and cannot be opened. After the power is restored, the lock is released.

Care and Maintenance

Cleaning the lint filter (cassette type)

- 1 Press down on the knob on the top of the lint filter (cassette type) and pull it towards you.
- 2 Open the lint filter (cassette type) to the sides and remove the lint that is inside.
- 3 Reverse the procedure to replace the lint filter (cassette type).

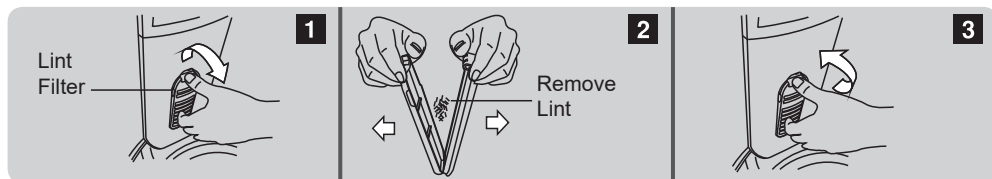

Cleaning the dispenser

- 1 Pull the dispenser and tilt it upwards to remove it.
- 2 Pull off the caps and Easy Dissolver.
- 3 Clean with some tools such as brush.
- 4 To remount, tilt the dispenser, align the rib to guide and insert it.

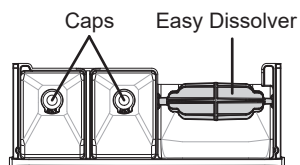

- When you replace the caps, press it until it stops completely. If it is not pressed all the way in, the softener, liquid detergent and liquid bleach will not be added to the tub completely and some will remain in the dispenser.

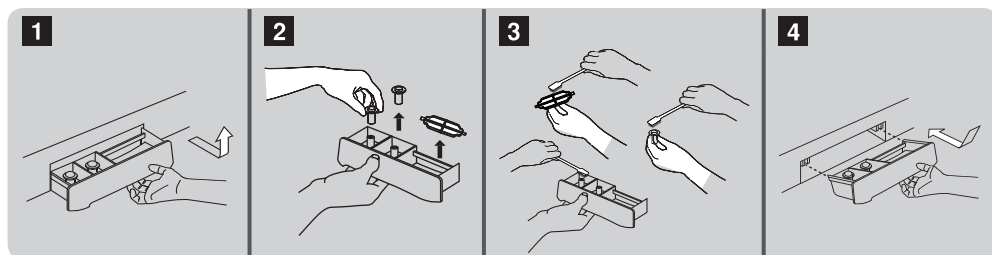

Cleaning the water supply inlet

- 1 Close the tap.
- 2 Disconnect the water supply hose from the top of the washing machine. (Water in the hose may be drained when you disconnect the hose.)
- 3 Use a brush or something to clean the water supply inlet of the washing machine.
- 4 Reverse the procedure to replace the water supply hose.

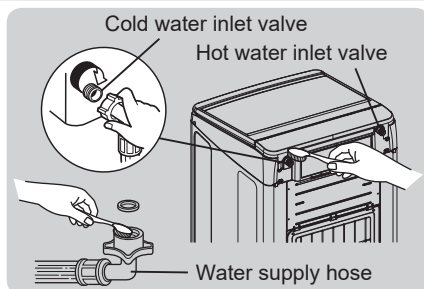

Care and maintenance of the washing machine

- Clean the machine body.
- Wipe the outside of the washing machine with a soft cloth. Do not use solvents such as alcohol or benzene.
- If you use a chemically treated cloth, use it according to the instructions given for the product.
- If detergent or softener gets on the washing machine, quickly wipe it off. The surface could be damaged.

Troubleshooting

Problem	Thing to check	Instructions
Washing Machine fails to operate	Is the power plug not inserted in the power outlet?	Insert in the power outlet.
	Is there a power outage?	Check other products in your home.
	Is the Delay Timer set?	Please check this function.
Washing Machine is wet, even though it is the first time to use it (drain hose, tub, etc.)	At factory, we are checking the actual performance of each product before shipment. Some water drops might remain in the product, but this is not a malfunction. We ask for your kind understanding.	Please clean with a soft cloth for Tub drying.
The remaining time increases during operation	Is remaining time adjusted to compensate for the speed of the incoming water?	Adjust water volume to high speed.
Water is added again during the washing process	Is water added automatically up to the set water level if the water level falls because water is absorbed by the laundry?	To keep the preset water level, water may be added during operation.
Wash time is longer than the time that was set manually	Is the water pressure low?	The operating time may increase due to a longer water supply time, depending on the pressure level of tap water.
The washing machine stops during the spin cycle and starts adding water	Are loaded clothes unbalanced?	If the laundry is extremely off balance when the spin cycle starts, the spin cycle stops and the rinse cycle starts to rebalance the laundry. After the load is rebalanced, the spin cycle starts again.
The lid does not open	Is the lid locked?	When the lid lock indicator is on, lid is still locked for your safety.
		Cannot be opened because there was a power outage or the power was turned off while the lid lock indicator was lit. Turn on the power and wait for the lock to be released.
The display screen becomes foggy	This is not the failure.	The fog disappears in approximately 24 hours and it does not affect the operation.

Error Codes

Error code	Description	Things to check	Solution
E0	Overloaded Laundry	Check if the laundry is overloaded?	Decrease the amount of laundry according to the instructions on page 16.
E1	Water is not supplied	Is the tap open?	Check the tap, water supply inlet filter, water pipes, and water supply hose.
		Has dirt collected in the water supply inlet filter?	
		Is the water pipe or water supply hose frozen?	
		Has the water supply been disrupted?	
		The discharge height less than 100 cm.	Install the drain hose properly. (see page 29)
E2	Water does not drain	Is the drain hose blocked?	Check drain hose, drain pump and drain outlet. If E2 still appears after removing the possible cause, please contact your local service center for repair.
		Is the drain hose twisted, crushed, or frozen?	
		Is the drain hose connected correctly?	
E3	The tub does not spin	Is the lid open?	Close the lid.
E4		Is the laundry all on one side of the tub?	Add a few more items to wash. (If there is only one item in the tub, it is likely to become unbalanced.)
	Does the laundry include too many thick items like cotton blankets or jeans or too many large items like sheets?		
	Is the washing machine wobbling, or is the floor under the washing machine slanted?		
	Are there any unwashable things in the tub? →Page 8: Preparation of the laundry (sorting the laundry)		
E8	The lid cannot be locked	Is the lid closed?	Check that the lid is completely closed. Check that there are no foreign objects in the lock switch.
		Are there any foreign objects in the lock switch?	
E9	The lid lock cannot be released	Are there any foreign objects in the lock switch?	Turn the power off and then on again and wait a little while. If the lid is still locked, contact a service center for repair.
E4	The spinning speed does not reach the specified value.	Check if there is too much detergent?	Check the amount of powder detergent used. Check the drain hose and its installation.
		Check if the drain hose is clogged?	
		Check if the drain hose is installed correctly?	

■ If warning sign such as "F0", "F9"...etc. are shown in the display, stop operating the washer immediately and contact an authorized service dealer or a service agent for further inspection and/or repairing.

How to Install the Washing Machine

Safety precautions

- Do not use a damaged power plug for your safety. Contact a repair center that is certified by the manufacturer to replace the plug.
- If the outlet you are using is a 2-pin outlet, use an adapter to change from three pins to two pins. When you do this, be sure to connect an earth wire. There are risk of electric shock, electronic substrate and electronic parts damage if you do not connect an earth wire.
- Do not connect an earth wire to a gas pipe, telephone wire, water pipe, or lightning rod. Remove the power plug from the electric outlet when you are attaching an earth wire.
- You do not need to attach an earth wire if the electric outlet is a 3-pin type with earth terminal.

Where to install the washing machine

- The hoses may be damaged if they are frozen. Do not install the washing machine outside or any other place with a risk of freezing.
- Install the washing machine on a solid level floor to avoid excessive vibration and noise.
- Do not install the washing machine in an extremely humid place, such as a bathroom or a place exposed to rain.
- Do not install the washing machine in a slippery or unstable location. Doing so could cause abnormal vibration.
- Install the washing machine away from walls as shown below to avoid abnormal noise and vibration.

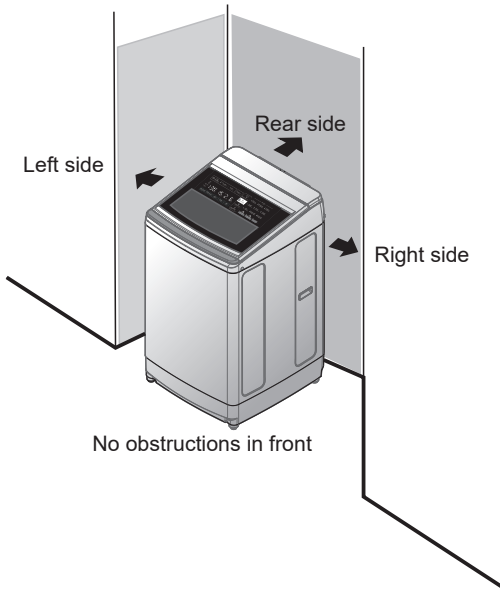

Area	Clearance
Left	15cm or more
Right	15cm or more
Rear	10cm or more

How to Install the Washing Machine

Connecting the water supply hose

- 1 Connect the water supply hose to the Cold and Hot water supply inlet on the washing machine.
- 2 Screw the union nut to arrow direction to firmly attach the water supply opening.
- 3 Make sure that the union nut between the water supply hose and main unit is tightly screwed.

- The optimum water pressure is 0.03 to 0.8MPa.
- Water leakage may occur if union nut is loosened.
- Unscrew the union nut when dismantling.

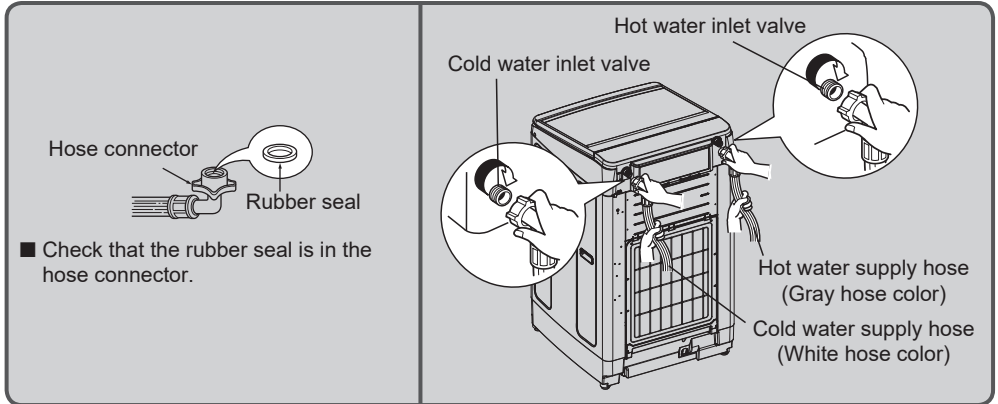

Connecting water supply hose to the tap

- 1 Tighten the water supply hose to water tap.

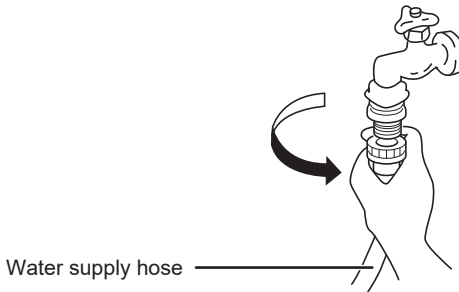

- When dismantling, after turn off water tap, press start button and run for 10 seconds for prevent water from spilling out during dismantling then dismantle the water supply hose.

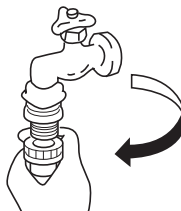

How to Install the Washing Machine

Installing the drain hose

- 1 Connect the drain hose to drain outlet and clamp tightly by the hose clamp.
- 2 Hook the U Shape holder end of the drain hose over the rim of a sink to drain.

- Don't lay down the drain hose, as water will be discharged.
- The discharge height should be approx. 100cm above the base of the washer.
- Be sure the drain hose is properly routed so it will not kink or lift from the sink.

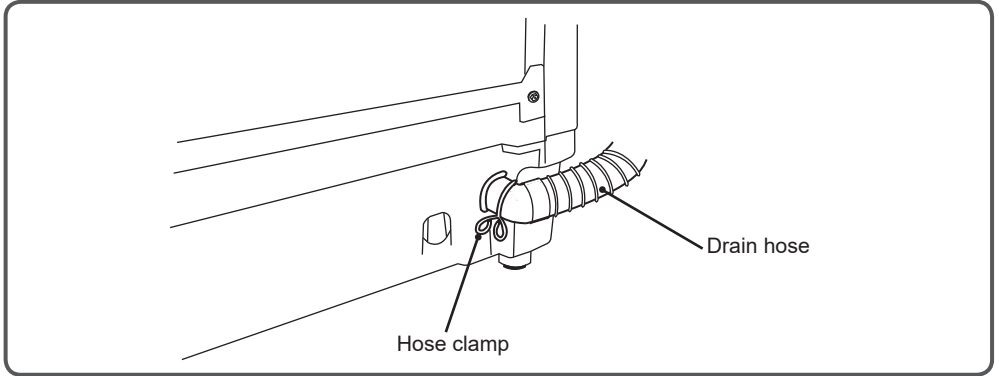

Note : How to place the end of drain hose

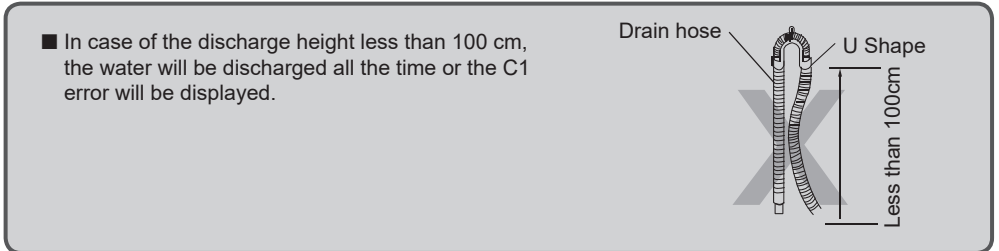
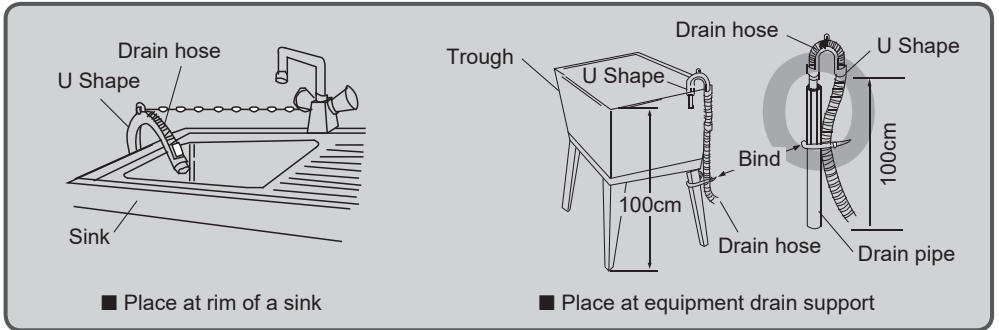

How to Install the Washing Machine

1. Installation of Washing Machine

- Move the Washing Machine to the setting area.
- Connect the Washing Machine correctly to a grounded AC power supply.
- The voltage of the power supply must match the voltage rating of the Washing Machine.
- Do not use extension cords or overload the power outlet by using power strips.

2. Check the horizontal level

According to the figure on the right, check the level by using a simple jig which can be made with string, pen and weight such as coin.

- If the gap between A and (A) are same, your Washing Machine is well leveled ($\pm 5\text{mm}$).

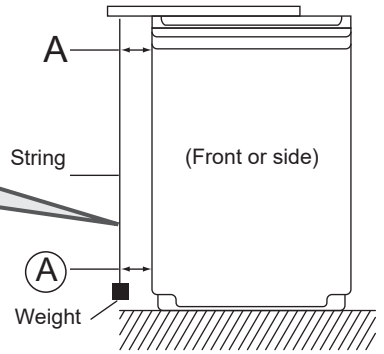

3. Check the level

- If the Washing Machine is not stable or when the floor itself is not leveled, please adjust the leg.

- Rotate the lock nut in the direction of the arrow to loosen it and then rotate the adjustable leg to stabilize the Washing Machine.
- When the adjustment is finished, rotate the lock nut in the direction of the arrow to tighten it.

4. Check the center of tub

- When the Washing Machine is leveled, please also make sure that the washing tub is positioned approximately in the center.

Note : Failing to do so may cause a vibration or abnormal operation.

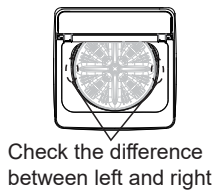

Checking after installation

If any of the following problems or other abnormalities occur, immediately unplug the power plug and contact your local service center.

- The Washing Machine does not operate when the power is turned on.
- The power cord is damaged.
- There are abnormal vibrations or sounds during operation.
- There is a smell of burning.

Customer Service

If the Washing Machine malfunctions, check the Instruction Manual thoroughly before you call for repairs.

If you are unable to identify or solve the problem, contact your local service center.

When you call the service center, you will need to tell them the model of the washing machine, describe the malfunction, and give them your address and phone number.

Specifications

Model	SF-P130TCV
Power supply	See the rating plate on the back of the washing machine.
Standard water level	99 L (maximum water level)
Standard amount of water used	175 L (Fuzzy program)
Water pressure	0.03 to 0.8 MPa (0.3 to 8 Kg/cm ²)
Dimensions	Width 640 mm x Depth 684 mm x Height 1047 mm
Weight	49 kg

Customer Service Center

Beko A&NZ Pty Ltd
55 Blanck Street, Ormeau, QLD 4208
Official Distributor of Hitachi Home Appliances
Phone: 1300 470 552
Web: www.hitachi-homeappliances.com/au-en/

- Telephone number is subject to change without notice.

