



Refrigerator

User manual

Free Standing Appliance

SAMSUNG

Contents

Safety information	3
What you need to know about the safety instructions	3
Important safety symbols and precautions:	5
Important safety precautions	6
Severe warning signs for transportation and site	9
Critical installation warnings	10
Installation cautions	14
Critical usage warnings	14
Usage cautions	19
Cleaning cautions	22
Critical disposal warnings	24
Additional tips for proper usage	25
Instructions about the WEEE	26
Installation	27
Refrigerator at a glance	28
Step-by-step installation	32
Operations	51
Main panel	51
Setting the desired temperature or function	53
Turning on or off the AutoFill Pitcher	54
Turning on or off the ice maker	54
Resetting or dismissing the water filter replacement alarm	55
SmartThings	56
Special features	59
Maintenance	66
Handling and care	66
Cleaning	70
Replacement	71
Troubleshooting	74
General	74
Do you hear abnormal sounds from the refrigerator?	78
SmartThings	80
Open Source Announcement	81

Safety information

Before using your new Samsung Refrigerator, please read this manual thoroughly to ensure that you know how to operate the features and functions that your new appliance offers safely and efficiently.

What you need to know about the safety instructions

- Warnings and Important Safety Instructions in this manual do not cover all possible conditions and situations that may occur.
It is your responsibility to use common sense, caution, and care when installing, maintaining, and operating your appliance.
- Because these following operating instructions cover various models, the characteristics of your refrigerator may differ slightly from those described in this manual and not all warning signs may be applicable. If you have any questions or concerns, contact your nearest service center or find help and information online at www.samsung.com.
- R-600a or R-134a is used as a refrigerant. Check the compressor label on the rear of the appliance or the rating label inside the fridge to see which refrigerant is used for your appliance. When this product contains flammable gas (Refrigerant R-600a), contact your local authority in regard to safe disposal of this product.
- In order to avoid the creation of a flammable gas-air mixture if a leak in the refrigerating circuit occurs, the size of the room in which the appliance may be sited depends on the amount of refrigerant used.

Safety information

- Never start up an appliance showing any signs of damage. If in doubt, consult your dealer. The room must be 1 m³ in size for every 8 g of R-600a refrigerant inside the appliance.
The amount of refrigerant in your particular appliance is shown on the identification plate inside the appliance.
- Refrigerant squirting out of the pipes could ignite or cause an eye injury. When refrigerant leaks from the pipe, avoid any naked flames and move anything flammable away from the product and ventilate the room immediately.
 - Failing to do so may result in fire or explosion.
- It is hazardous for anyone other than an Authorized Service Person to service this appliance.
- In Queensland - the authorized Service Person MUST hold a Gas Work Authorisation or Licence for hydrocarbon refrigerants, to carry out Servicing or repairs which involve the removal of covers. (For Australia only)



Important safety symbols and precautions:

Please follow all safety instructions in this manual. This manual uses the following safety symbols.

WARNING

Hazards or unsafe practices that may result in **severe personal injury, property damage, and/or death.**

CAUTION

Hazards or unsafe practices that may result in **severe personal injury and/or property damage.**

NOTE

Useful information that helps users understand or benefit from the refrigerator.

These warning signs are here to prevent injury to you and others.

Please follow them carefully.

After reading this section, keep it in a safe place for future reference.



Safety information

Important safety precautions



Warning; Risk of fire / flammable materials

WARNING

- When positioning the appliance, ensure the supply cord is not trapped or damaged.
- Do not locate multiple portable socket-outlets or portable power supplies at the rear of the appliance.
- Fill with potable water only.
- Connect to potable water supply only.
- Keep ventilation openings, in the appliance enclosure or in the built-in structure, clear of obstruction.
- Do not use mechanical devices or any other means to accelerate the defrosting process, other than those recommended by the manufacturer.
- Do not damage the refrigerant circuit.
- Do not use electrical appliances inside the food storage compartments of the appliance, unless they are of the type recommended by the manufacturer.

- This appliance is not intended for use by persons (including children) with reduced physical, sensory, or mental capabilities, or those who lack experience and knowledge, unless they have been given supervision or instruction concerning the use of the appliance by a person responsible for their safety.

- This appliance can be used by children aged from 8 years and above and persons with reduced physical, sensory or mental capabilities or lack of experience and knowledge if they have been given supervision or instruction concerning use of the appliance in a safe way and understand the hazards involved. Children shall not play with the appliance. Cleaning and user maintenance shall not be made by children without supervision. Children aged from 3 to 8 years are allowed to load and unload refrigerating appliances.
- If the supply cord is damaged, it must be replaced by the manufacturer, its service agent or similarly qualified persons in order to avoid a hazard.
- The socket must be easily accessible so that the appliance can be quickly disconnected from the supply in an emergency.
 - It must be outside the area of the rear of the appliance.
- Do not store explosive substances such as aerosol cans with a flammable propellant in this appliance.
- If the product is equipped with LED lamps, do not disassemble the Lamp Covers and LED lamps yourself.
 - Contact a Samsung service center.
 - Use only the LED Lamps provided by the manufacturer or its service agents.
- New hose-sets supplied with the appliance are to be used and old hose-sets should not be reused.
- Have the refrigerator's water supply connected only to a potable water supply. To operate the ice maker properly, water pressure of 206-861 kPa (30-125 psi) is required.



Safety information

- For the most efficient use of energy, please keep the all inner fittings such as baskets, drawers, shelves on the position supplied by manufacturer.
- To get the best energy efficiency of this product, please leave all shelves, drawers and baskets on their original position.

How to minimize the energy consumption

- Install the appliance in a cool, dry room with adequate ventilation.
- Ensure that it is not exposed to direct sunlight and never put it near a direct source of heat (radiator, for example).
 - Not to block any vents or grilles is recommended for energy efficiency.
 - Allow warm food to cool down before placing it in the appliance.
 - Put frozen food in the refrigerator to thaw. You can then use the low temperatures of the frozen products to cool food in the refrigerator.
 - Do not keep the door of the appliance open for too long when putting food in or taking food out.
 - The shorter time for which the door is open, the less ice will form in the freezer.
 - Clean the rear of the refrigerator regularly. Dust increases energy consumption.
 - Do not set temperature colder than necessary.
 - Ensure sufficient air exhaust at the refrigerator base and at the back wall of the refrigerator. Do not cover air vent openings.



-
- Allow clearance to the right, left, back and top when installing. This will help reduce power consumption and keep your energy bills lower.

This appliance is intended to be used in household and similar applications such as

- staff kitchen areas in shops, offices and other working environments;
- farm houses and by clients in hotels, motels and other residential type environments;
- bed and breakfast type environments;
- catering and similar non-retail applications.

Severe warning signs for transportation and site

WARNING

- When transporting and installing the appliance, care should be taken to ensure that no parts of the refrigerating circuit are damaged.
 - Refrigerant leaking from the pipe work could ignite or cause an eye injury. If a leak is detected, avoid any naked flames or potential sources of ignition and air the room in which the appliance is standing for several minutes.

Safety information

- This appliance contains a small amount of isobutane refrigerant (R-600a), a natural gas with high environmental compatibility that is, however, also combustible. When transporting and installing the appliance, care should be taken to ensure that no parts of the refrigerating circuit are damaged.
- When transporting and installing the refrigerator, do not touch the water hose on the back side of the refrigerator.
 - This may damage the refrigerator and as a result the water dispenser can not be used.

Critical installation warnings

WARNING

- Do not install the refrigerator in a damp location or place where it may come in contact with water.
 - Deteriorated insulation on electrical parts may cause an electric shock or fire.
- Do not place this refrigerator in direct sunlight or expose it to the heat from stoves, room heaters, or other appliances.
- Do not plug several appliances into the same multiple power strip. The refrigerator should always be plugged into its own individual electrical outlet which has a voltage rating that matches the voltage listed on the refrigerator's rating plate.
 - This provides the best performance and also prevents overloading of house wiring circuits, which could cause a fire hazard from overheated wires.

-
- If the wall socket is loose, do not insert the power plug.
 - There is a risk of electric shock or fire.
 - Do not use a power cord that has cracks or abrasion damage along its length or at either end.
 - Do not bend the power cord excessively or place heavy objects on it.
 - Do not pull or excessively bend the power cord.
 - Do not twist or tie the power cord.
 - Do not hook the power cord over a metal object, place a heavy object on the power cord, insert the power cord between objects, or push the power cord into the space behind the appliance.
 - When moving the refrigerator, be careful not to roll over or damage the power cord.
 - This may result in an electric shock or fire.
 - Never unplug your refrigerator by pulling on the power cord. Always grip the plug firmly and pull straight out from the outlet.
 - Damage to the cord may cause a short-circuit, fire, and/or electric shock.
 - Do not use aerosols near the refrigerator.
 - Using aerosols near the refrigerator may cause an explosion or fire.
 - Do not install this appliance near a heater or inflammable material.
 - Do not install this appliance in a location where gas may leak.
 - This may result in an electric shock or fire.

Safety information

- This refrigerator must be properly located and installed in accordance with the instructions in this manual before you use it.
- Connect the power plug in the proper position with the cord hanging down.
 - If you connect the power plug upside down, the wire can get cut off and cause a fire or electric shock.
- Make sure that the power plug is not crushed or damaged by the back of the refrigerator.
- Keep the packing materials out of reach of children.
 - There is a risk of death from suffocation if a child puts the packing materials on his or her head.
- Do not install this appliance in a humid, oily or dusty location, in a location exposed to direct sunlight and water (rain drops).
 - Deteriorated insulation of electrical parts may cause an electric shock or fire.
- If any dust or water is in the refrigerator, pull out power plug and contact your Samsung Electronics service center.
 - Otherwise there is a risk of fire.
- Do not stand on top of the appliance or place objects (such as laundry, lighted candles, lighted cigarettes, dishes, chemicals, metal objects, etc.) on the appliance.
 - This may result in an electric shock, fire, problems with the product, or injury.
- You need to remove all the protective plastic film before you initially plug the product in.

-
- Children should be supervised to ensure that they do not play with the snap rings used for door adjustment or the water tube clips.
 - There is risk of death by suffocation if a child swallows a snap ring or water tube clip. Keep the snap rings and water tube clips out of children's reach.
 - The refrigerator must be safely grounded.
 - Always make sure that you have grounded the refrigerator before attempting to investigate or repair any part of the appliance. Power leakages can cause severe electric shock.
 - Never use gas pipes, telephone lines, or other potential lightning attractors as an electrical ground.
 - You must ground the refrigerator to prevent any power leakages or electric shocks caused by current leakage from the refrigerator.
 - This may result in an electric shock, fire, explosion, or problems with the product.
 - Plug the power plug into the wall socket firmly. Do not use a damaged power plug, damaged power cord, or loose wall socket.
 - This may result in an electric shock or fire.
 - The fuse on the refrigerator must be changed by a qualified technician or service company.
 - Failing to do so may result in an electric shock or personal injury.

Safety information

Installation cautions

CAUTION

- Allow sufficient space around the refrigerator and install it on a flat surface.
 - If your refrigerator is not level, cooling efficiency and durability can be declined.
- Allow the appliance to stand for 2-3 hours before loading foods after installation and turning on.
- We strongly recommend you have a qualified technician or service company install the refrigerator.
 - Failing to do so may result in an electric shock, fire, explosion, problems with the product, or injury.

Critical usage warnings

WARNING

- Do not insert the power plug into a wall socket with wet hands.
 - This may result in an electric shock.
- Do not store articles on the top of the appliance.
 - When you open or close the door, the articles may fall and cause personal injury and/or material damage.
- Do not insert hands, feet or metal objects (such as chopsticks, etc.) into the bottom or the back of the refrigerator.
 - This may result in an electric shock or injury.
 - Any sharp edges may cause a personal injury.

-
- Do not touch the inside walls of the freezer or products stored in the freezer with wet hands.
 - This may cause frostbite.
 - Do not put a container filled with water on the refrigerator.
 - If spilled, there is a risk of fire or electric shock.
 - Do not keep volatile or flammable objects or substances (benzene, thinner, propane gas, alcohol, ether, LP gas, and other such products) in the refrigerator.
 - This refrigerator is for storing food only.
 - This may result in fire or explosion.
 - Children should be supervised to ensure that they do not play with the appliance.
 - Keep fingers out of “pinch point” areas. Clearances between the doors and cabinet are necessarily small. Be careful when you open the doors if children are in the area.
 - Do not put your fingers or children's fingers between the doors.
 - Keep fingers out of the left and right door gaps. Be careful when you open the doors if your fingers are in between the doors.
 - Do not let children hang on the door or door bins. A serious injury may occur.
 - Do not let children go inside the refrigerator. They could become trapped.
 - Do not insert your hands into the bottom area under the appliance.
 - Any sharp edges may cause personal injury.

Safety information

- Do not store pharmaceutical products, scientific materials, or temperature sensitive products in the refrigerator.
 - Products that require strict temperature controls must not be stored in the refrigerator.
- If you smell pharmaceutical or smoke, pull out power plug immediately and contact your Samsung Electronics service center.
- If any dust or water is in Refrigerator, pull out power plug and contact your Samsung Electronics service center.
 - Otherwise there is a risk of fire.
- Do not let children step on a drawer.
 - The drawer may break and cause them to slip.
- Do not leave the doors of the refrigerator open while the refrigerator is unattended and do not let children enter inside the refrigerator.
- Do not allow babies or children go inside the drawer.
 - It can cause death from suffocation by entrapment or personal injury.
- Do not overfill the refrigerator with food.
 - When you open the door, an item may fall out and cause personal injury or material damage.
- Do not spray volatile material such as insecticide onto the surface of the appliance.
 - As well as being harmful to humans, it may also result in an electric shock, fire, or problems with the product.
- Never put fingers or other objects into the water dispenser hole, ice chute and ice maker bucket.
 - It may cause a personal injury or material damage.

- Do not use or place any substances sensitive to temperature such as flammable sprays, flammable objects, dry ice, medicine, or chemicals near or inside of the refrigerator.
- Do not use a hair dryer to dry the inside of the refrigerator. Do not place a lighted candle in the refrigerator for removing bad odours.
 - This may result in an electric shock or fire.
- Fill the water tank, ice tray and water cubes only with potable water (mineral water or purified water).
 - Do not fill the tank with tea, juice or sports drink, this may damage the refrigerator.
- Do not stand on top of the appliance or place objects (such as laundry, lighted candles, lighted cigarettes, dishes, chemicals, metal objects, etc.) on the appliance. This may result in an electric shock, fire, problems with the product, or injury. Do not put a container filled with water on the appliance.
 - If spilled, there is a risk of fire or electric shock.
- Never stare directly at the UV LED lamp for long periods of time.
 - This may result in eye strain due to the ultraviolet rays.
- Do not put shelf in upside down. Shelf stopper could not work.
 - It may cause a personal injury because of glass shelf drop.
- Keep fingers out of “pinch point” areas. Clearances between the doors and cabinet are necessarily small. Be careful when you open the doors if children are in the area.

Safety information

- If a gas leak is detected, avoid any naked flames or potential sources of ignition, and air the room in which the appliance is standing for several minutes.
 - Do not touch the appliance or power cord.
 - Do not use a ventilating fan.
 - A spark may result in explosion or fire.
- Bottles should be stored tightly together so that they do not fall out.
- This product is intended only for the storage of food in a domestic environment.
- Never put fingers or other objects into the water dispenser hole, ice chute and ice maker bucket.
 - It may cause a personal injury or material damage.
- Do not attempt to repair, disassemble, or modify the refrigerator yourself.
- Do not use any fuse (such as cooper, steel wire, etc.) other than a standard fuse.
- If your refrigerator needs to be repaired or reinstalled, contact your nearest service center.
 - Failing to do so may result in an electric shock, fire, problems with the product, or injury.
- If the refrigerator emits a burning smell or smoke, unplug the refrigerator immediately and contact your Samsung Electronics service center.
 - Failing to do so may result in an electric or fire hazards.
- Pull the power plug out of the socket before changing the interior lamps of the refrigerator.
 - Otherwise, there is a risk of electric shock.
- If you experience difficulty changing a non-LED light, contact a Samsung service center.

-
- Plug the power plug into the wall socket firmly.
 - Do not use a damaged power plug, damaged power cord or loose wall socket.
 - This may result in an electric shock or fire.

Usage cautions

CAUTION

- Do not refreeze thawed food.
 - Frozen and thawed food will develop harmful bacteria faster than fresh.
 - The second thaw will break down even more cells, leaching out moisture and changing the integrity of the product.
- Do not thaw meat at room temperature.
 - Safety will depend on whether the raw product was handled properly.
- Do not place glass bottles or carbonated beverages into the freezer.
 - The container may freeze and break, and this may result in injury.
- Use only the ice maker provided with the refrigerator.
- If you will be away from home for a long period of time (on vacation, for example) and won't be using the water or ice dispensers, close the water valve.
 - Otherwise, water leakage may occur.

Safety information

- If you won't be using the refrigerator for a very long period of time, (3 weeks or more) empty the refrigerator including the ice bucket, unplug it, close the water valve, wipe excess moisture from the inside walls, and leave the doors open to prevent odors and mold.
- To get the best performance from the product:
 - Do not place food too close to the vents at the rear of the refrigerator as this can obstruct free air circulation in the refrigerator compartment.
 - Wrap food up properly or place it in airtight containers before putting it into the refrigerator.
 - Please observe maximum storage times and expiration dates of frozen goods.
 - There is no need to disconnect the refrigerator from the power supply if you will be away for less than three weeks. However, if you will be away for more than three weeks, remove all the food and ice in the ice bucket, unplug the refrigerator, close the water valve, wipe excess moisture from the inside walls, and leave the doors open to prevent odors and mold.
- Service Warranty and Modification.
 - Any changes or modifications performed by a 3rd party on this finished appliance are not covered under Samsung warranty service, nor is Samsung responsible for safety issues that result from 3rd party modifications.

-
- Do not block the air vents inside the refrigerator.
 - If the air vents are blocked, especially with a plastic bag, the refrigerator can be over cooled. If a cooling period lasts too long, the water filter may break and cause water leakage.
 - Use only the ice-maker provided with the refrigerator.
 - Wipe excess moisture from the inside and leave the doors open.
 - Otherwise, odor and mold may develop.
 - If the refrigerator is disconnected from the power supply, you should wait for at least five minutes before plugging it back in.
 - When the refrigerator got wet by water, pull out the power plug and contact your Samsung Electronics service center.
 - Do not strike or apply excessive force to any glass surface.
 - Broken glass may result in a personal injury and/or property damage.
 - Fill the water tank and ice cube trays with potable water only (tap water, mineral water, or purified water).
 - Do not fill the tank with tea or a sports drink. This may damage the refrigerator.
 - Be careful that your fingers are not caught in.
 - If the refrigerator is flooded, make sure to contact your nearest service center.
 - There is a risk of electric shock or fire.

Safety information

- Do not keep vegetable oil in your refrigerator's door bins. The oil can solidify, making it foul-tasting and difficult to use. In addition, the open container can leak and the leaked oil can cause the door bin to crack. After opening an oil container, it is best to keep the container in a cool and shaded place such as a cupboard or pantry.
 - Examples of vegetable oil: olive oil, corn oil, grape-seed oil, etc.

Cleaning cautions

CAUTION

- Do not spray water directly on the inside or outside the refrigerator.
 - There is a risk of fire or electric shock.
- Do not use a hair dryer to dry the inside of the refrigerator.
- Do not place a lighted candle in the refrigerator to remove bad odors.
 - This may result in an electric shock or fire.
- Do not spray cleaning products directly on the display.
 - Printed letters on the display may come off.
- If any foreign substance such as water has entered the appliance, unplug the power plug and contact your nearest service center.
 - Failing to do so may result in an electric shock or fire.

-
- Use a clean, dry cloth to remove any foreign matter or dust from the power plug blades. Do not use a wet or damp cloth when cleaning the plug.
 - Otherwise, there is a risk of fire or electric shock.
 - Do not clean the appliance by spraying water directly onto it.
 - Do not use benzene, thinner, or Clorox, Chloride for cleaning.
 - They may damage the surface of the appliance and may cause a fire.
 - Never put fingers or other objects into the dispenser hole.
 - It may cause a personal injury or material damage.
 - Before cleaning or performing maintenance, unplug the appliance from the wall socket.
 - Failing to do so may result in an electric shock or fire.
 - Use a clean sponge or soft cloth and a mild detergent in warm water to clean the refrigerator.
 - Do not use abrasive or harsh cleansers such as window sprays, scouring cleansers, flammable fluids, muriatic acid, cleaning waxes, concentrated detergents, bleaches, or cleansers containing petroleum products on exterior surfaces (doors and cabinet), plastic parts, door and interior liners, and gaskets.
 - These can scratch or damage the material.
 - Do not clean glass shelves or covers with warm water when they are cold. Glass shelves and covers may break if exposed to sudden temperature changes or impacts such as bumping or dropping.

Safety information

Critical disposal warnings

WARNING

- Please dispose of the packaging material from this product in an environmentally friendly manner.
- Ensure that none of the pipes on the back of the refrigerator are damaged prior to disposal.
- R-600a or R-134a is used as a refrigerant. Check the compressor label on the rear of the appliance or the rating label inside the fridge to see which refrigerant is used for your refrigerator. If this refrigerator contains flammable gas (Refrigerant R-600a), contact your local authority in regard to safe disposal of this product.
- When disposing of this refrigerator, remove the door/door seals and door latch so that small children or animals cannot become trapped inside. Children should be supervised to ensure that they do not play with the appliance. If trapped inside, a child may get hurt or suffocate to death.
 - If trapped inside, the child may become injury and suffocate to death.
- Cyclopentane is used in the insulation. The gases in the insulation material require a special disposal procedure. Please contact your local authorities in regard to the environmentally safe disposal of this product.
- Keep all packaging materials well out of the reach of children, as packaging materials can be dangerous to children.
 - If a child places a bag over his or her head, the child could suffocate.

Additional tips for proper usage

- In the event of a power failure, call the local office of your electric company and ask how long the failure is going to last.
 - Most power failures that are corrected in an hour or two will not affect your refrigerator temperatures. However, you should minimize the number of door openings while the power is off.
 - Should the power failure last more than 24 hours, remove and discard all frozen food.
- The refrigerator might not operate consistently (frozen contents can thaw or temperatures can become too warm in the frozen food compartment) if sited for an extended period of time in a location where ambient air temperatures are constantly below the temperatures for which the appliance is designed.
- In case of particular foods, keeping it under refrigeration can have a bad effect on preservation due to its properties.
- Your appliance is frost free, which means there is no need to manually defrost your appliance. This will be carried out automatically.
- Temperature rise during defrosting complies with ISO requirements. If you want to prevent an undue rise in the temperature of frozen food while the appliance defrosts, wrap the frozen food in several layers of newspaper.
- Do not re-freeze frozen foods that have thawed completely.



Safety information

- The temperature of two star section (sections) or compartment (compartments) which have two star symbol (❄️❄️) is slightly higher than other freezer compartment (compartments).
The two star section (sections) or compartment (compartments) is (are) based on the instruction and/or the condition as delivered.

Instructions about the WEEE

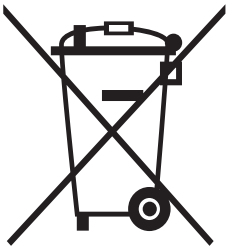

Correct Disposal of This Product (Waste Electrical & Electronic Equipment)

(Applicable in countries with separate collection systems)

This marking on the product, accessories or literature indicates that the product and its electronic accessories (e.g. charger, headset, USB cable) should not be disposed of with other household waste at the end of their working life. To prevent possible harm to the environment or human health from uncontrolled waste disposal, please separate these items from other types of waste and recycle them responsibly to promote the sustainable reuse of material resources.

Household users should contact either the retailer where they purchased this product, or their local government office, for details of where and how they can take these items for environmentally safe recycling.

Business users should contact their supplier and check the terms and conditions of the purchase contract. This product and its electronic accessories should not be mixed with other commercial wastes for disposal.

For information on Samsung’s environmental commitments and product regulatory obligations, e.g. REACH, WEEE or Batteries, visit our sustainability page available via www.samsung.com

(For products sold in European countries and in the UK only)



Installation

Follow these instructions carefully to ensure a proper installation of this refrigerator and to prevent accidents before using it.

WARNING

- Use the refrigerator only for its intended purpose as described in this manual.
- Any servicing must be performed by a qualified technician.
- Dispose of the product packaging material in compliance with the local regulations.
- To prevent electric shock, unplug the power plug before servicing or replacing parts.

Installation

Refrigerator at a glance

The actual refrigerator and provided component parts of your refrigerator may differ from the illustrations in this manual, depending on the model and the country.

Type A

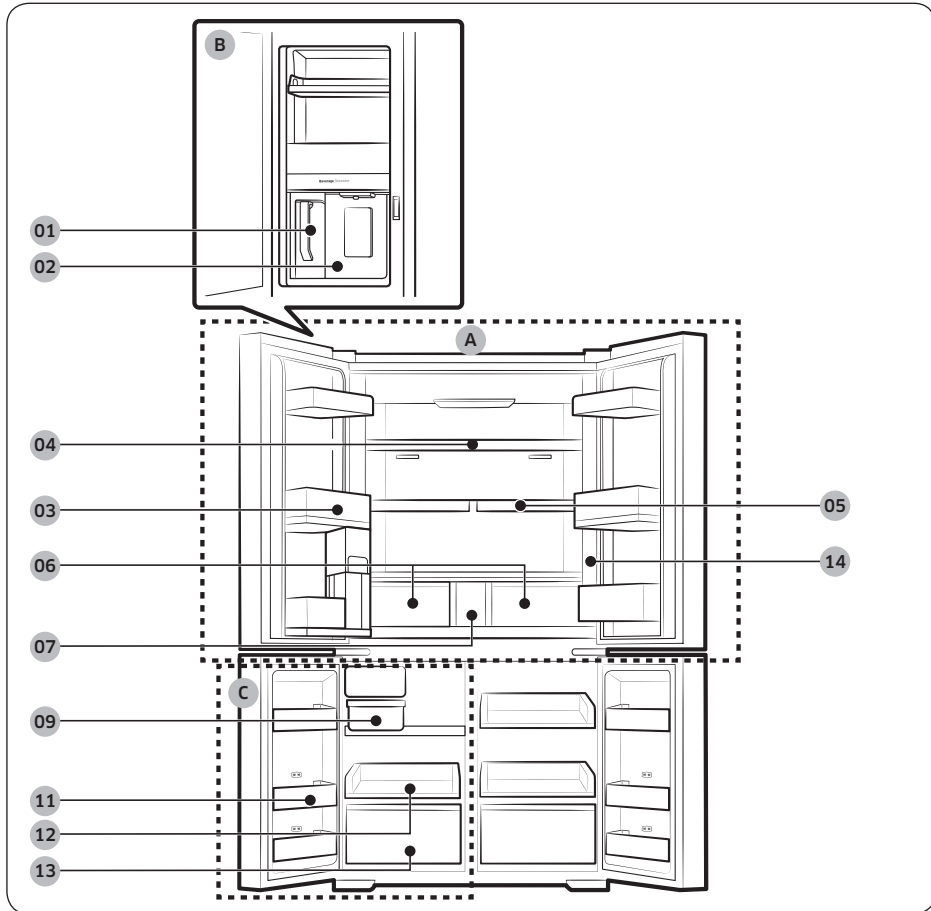

Type B

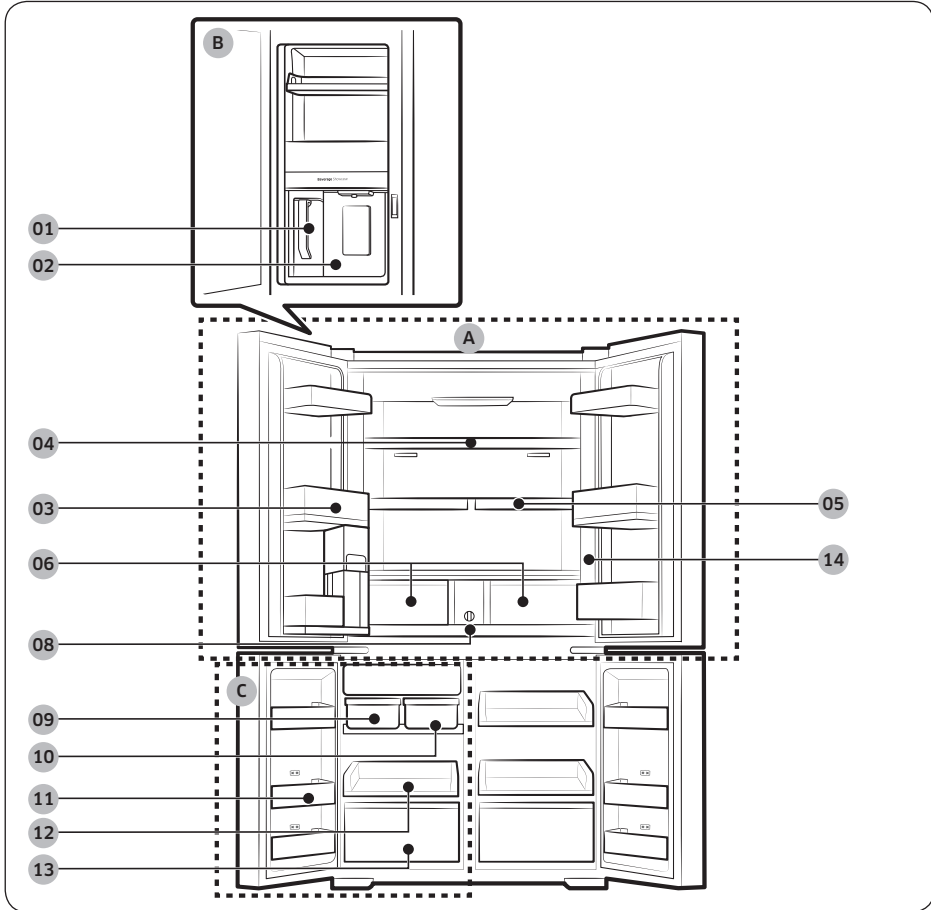



Installation

01 AutoFill Pitcher **

02 Water dispenser **

03 Fridge door bin

04 Fridge shelf

05 Quick Space shelf *

06 Crisper / Flex Crisper Drawers *

07 Water tank *

08 Water filter *

09 Auto ice maker - Cubed Ice

10 Auto ice maker - Ice Bites *

11 Freezer door bin

12 Freezer shelf

13 Freezer drawer

14 Main panel

* Applicable models only

** Dispenser models only

NOTE

- For energy efficiency, keep all shelves, drawers, and baskets in their original positions.
- When closing the door, make sure the vertical hinged section is in the correct position to avoid scratching the other door.
- If the vertical hinged section is reversed, put it back into the correct position, and then close the door.
- Moisture may form at times on the vertical hinged section.
- If you close a door forcefully, the other door may open.
- If the internal or external LED lamp is out of order, contact a local Samsung service center.

A. Fridge

B. Beverage Center **

C. Freezer



Door bins

Your refrigerator ships with door bins of different types and sizes. If the door bins for your refrigerator were packaged separately, use the figure below to help you position the bins properly.

NOTE

The actual refrigerator and provided component parts of your refrigerator may differ from the illustrations in this manual, depending on the model and the country.

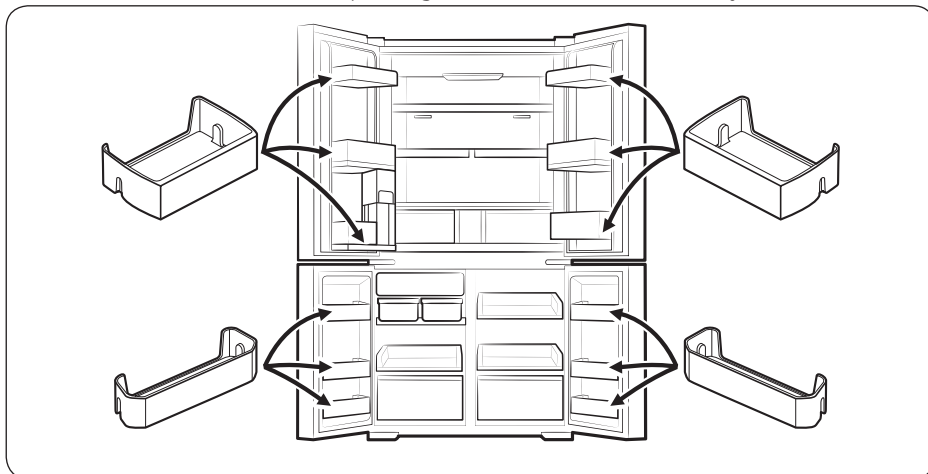

Installation

Step-by-step installation

STEP 1 Select a site

The site must:

- Have a solid level surface without carpeting or flooring that may obstruct ventilation
- Be out of direct sunlight
- Have adequate room for opening and closing the door
- Be away from any heat source
- Provide room for maintenance and servicing
- Have a temperature range between 10 °C and 43 °C

Clearance

See the following figures and tables for installation space requirements.

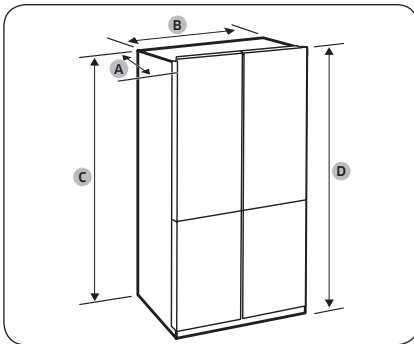

Model	RF59C7*	RF59CB* (BESPOKE)
Depth "A"	723 mm	730 mm
Width "B"	912 mm	912 mm
Height "C"	1748 mm	1748 mm
Overall Height "D"	1779 mm	1779 mm

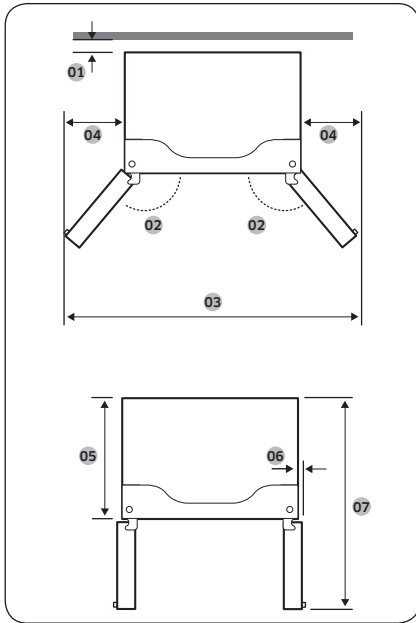

Model	RF59C7*	RF59CB* (BESPOKE)
01	more than 50 mm recommended	
02	125°	
03	1488 mm	1498 mm
04	290 mm	295 mm
05	610 mm	610 mm
06	54 mm	60 mm
07	1093 mm	1093 mm

NOTE

The measurements in the tables may differ slightly from the actual measurements, depending on the measuring and rounding method.

Installation

STEP 2 Flooring

If the refrigerator cannot pass through the entrance due to its size, see **Door removal for entrance**.

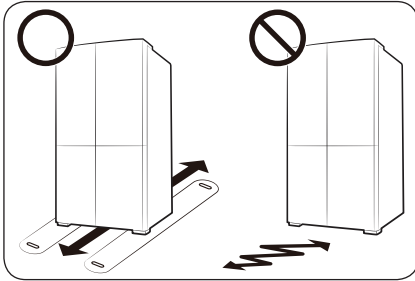

NOTE

To prevent floor damage, make sure the front leveling legs are in the upright position.

- The surface you install the refrigerator on must support a fully loaded refrigerator.
- To protect the floor, put a large piece of cardboard along the path to the refrigerator's final installation location.
- Once the refrigerator is in its final position, do not move it unless necessary to protect the floor. If you have to move the refrigerator, place thick paper or cloth such as old carpets along the path of movement.

STEP 3 Door removal for entrance

If the refrigerator cannot pass through the entrance to your home or kitchen due to its size, follow these instructions to remove and then re-install the refrigerator's doors. If you do not need to remove the doors, go to page 43 to continue the installation procedure.

⚠ WARNING

Unplug the power cord of the refrigerator before removing the doors.

Tools required (not provided)

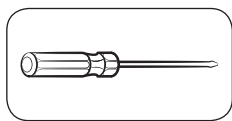

Phillips screwdriver

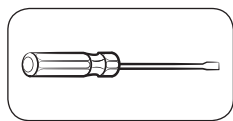

Flat-head screwdriver

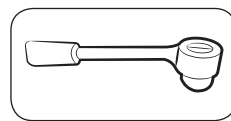

Socket wrench $\frac{3}{8}$ " (10 mm)

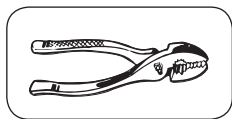

Pliers

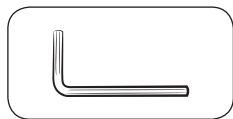

Allen wrench $\frac{1}{4}$ " (5 mm)

Detach the fridge doors

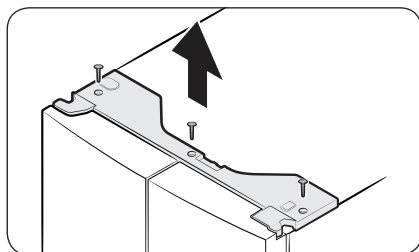

1. With the doors closed, use a Phillips screwdriver to remove the screws (x3) from the top cover. Pull up and remove the top cover with the connectors.

Installation

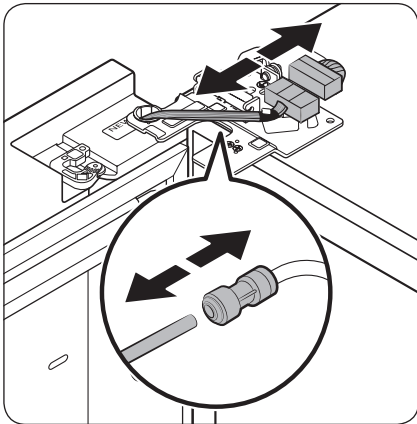

2. Disconnect the two wire connectors on the left door. The position of the connectors differs with the model.

⚠ CAUTION

- Do not remove both doors simultaneously. Make sure to remove one door at a time. Otherwise, any of the doors may fall and cause physical injury.
 - Make sure the refrigerator is off before disconnecting the connectors.
3. Disconnect the water tube from the coupler on the left door as shown.
 - This step does not apply to the models without the AutoFill Pitcher and the water dispenser.

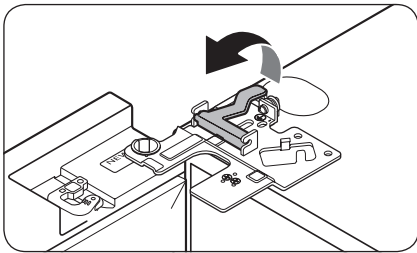

4. Gently draw up the clamp in several steps. To prevent finger injuries, do not apply a sudden force to the clamp.

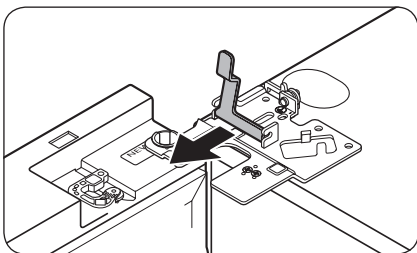

5. Pull up the clamp to remove.

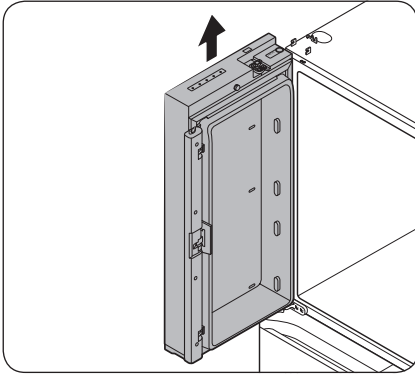
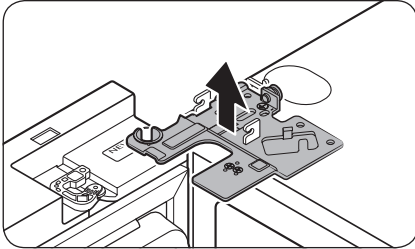

6. Open the door 90 degrees. While holding the door, pull up and remove the top hinge. Be careful not to damage the connector wires when you remove the hinge.

7. Gently pull up the door vertically to remove. Do not apply excessive force to the door. The door may fall, causing physical injury.

8. Lay the door down on a flat surface.

9. Repeat steps 1-8 for the other door, except for step 3. There is no water tube on the right side door.

- Step 2 does not apply to the models without the Showcase door.

Installation

Detach the freezer doors

⚠ CAUTION

- Be sure to remove the fridge doors before removing the freezer doors.
- Use caution when disconnecting the bottom connectors.

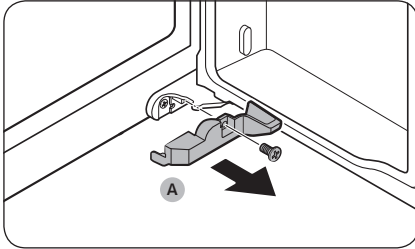

1. Open the freezer door.
2. Use a Phillips screwdriver to remove the screw holding the **cover (A)**.

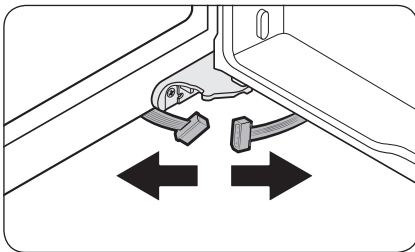

3. Disconnect the wire connectors.

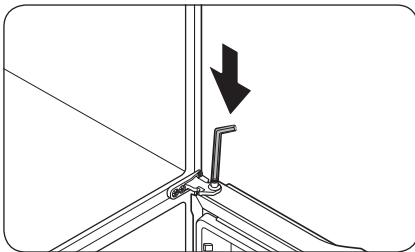

4. Locate the hinge shaft. While holding the door with one hand, use a flat-head screwdriver or Allen wrench to press the shaft down. Make sure to hold the door to prevent the door from falling.

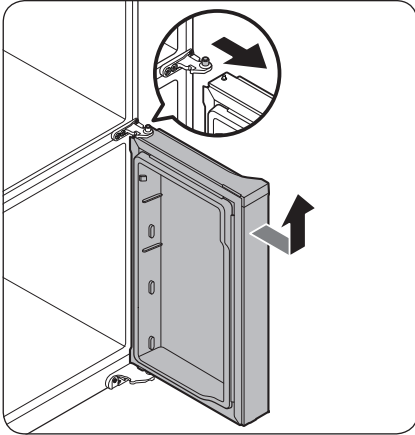

5. To prevent contact with the middle hinge, slightly tilt the door to the front, and then lift it up to remove.
6. Repeat steps 1-5 for the other door, except for steps 2 and 3.

To reattach the freezer doors

⚠ CAUTION

- After re-attaching the doors, make sure all the electrical connectors are properly connected.
- The freezer doors must be re-attached before the fridge doors.
- Be careful not to damage or step on the wires during this process.

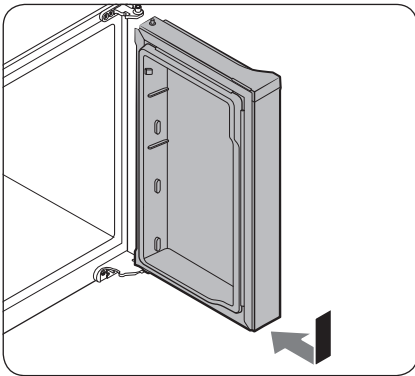

1. Insert the freezer door into the bottom hinge while pushing the freezer door in the direction of the arrow.

⚠ CAUTION

- Be careful not to damage or step on the wires during this process.

Installation

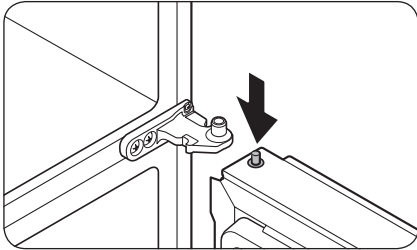

2. While pressing the hinge shaft down, position the door so that the hinge shaft is below the shaft hole in the middle hinge. Release the hinge shaft so that it enters the shaft hole.

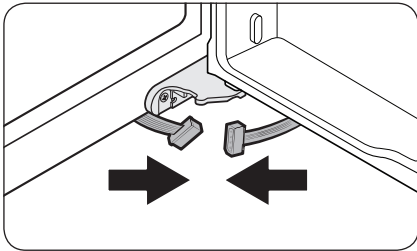

3. With the door open, connect the bottom connectors in the direction of the arrows.

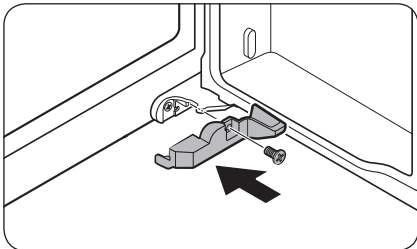

4. Attach the cover using a Phillips screwdriver. Be careful not to damage or step on the connectors.
5. Repeat steps 1-5 for the other door, except for steps 3 and 4.

To reattach the fridge doors

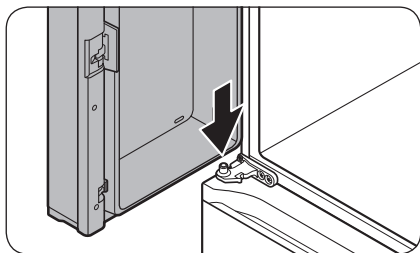

1. While holding the door open by more than 90 degrees, insert the shaft on the middle hinge into the hole on the bottom of the door.

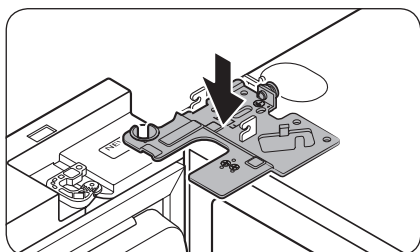

2. Put the top hinge into position on the top of the refrigerator, and then insert the hinge shaft into the top hole of the door. Make sure the wires from the door pass through the hole in the hinge shaft.

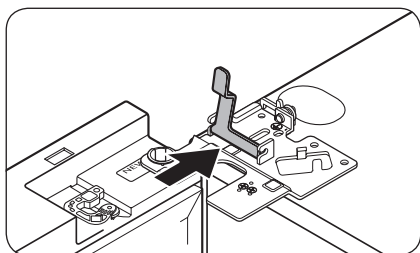

3. Insert the clamp in the direction of the arrow.

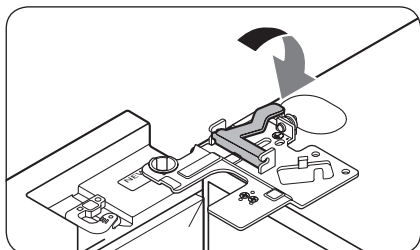

4. Push back the clamp as shown.

Installation

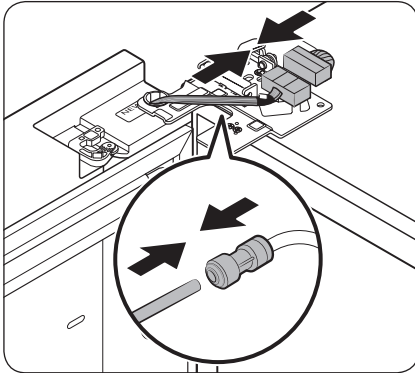

5. Connect the wire connectors.

⚠ CAUTION

- Make sure the wire connectors are connected properly. Otherwise, the display will not operate.

6. Connect the water tube.

- This step does not apply to the models without the AutoFill Pitcher and the water dispenser.

⚠ CAUTION

- To prevent water leaks, make sure the red clips tighten the coupler properly.
- Keep the clips out of children's reach.

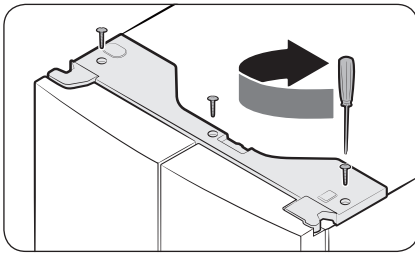

7. Repeat steps 1-5 for the other door.

- Step 5 does not apply to the models without the Showcase door.

8. Attach the top cover with the front side first, and then press down on its back to get it into position. Then, tighten the screws (x3).

STEP 4 Leveling the refrigerator

⚠ CAUTION

- When installed, the refrigerator must be leveled on a flat, solid floor. Not leveling the refrigerator can cause damage to the refrigerator or physical injury.
- Leveling must be performed with the refrigerator empty. Make sure no food items are inside the refrigerator.
- For safety reasons, adjust the front a little higher than the rear.

Level the refrigerator using the special screws (levelers) on the front legs. Use a flat-head screwdriver to turn the levelers.

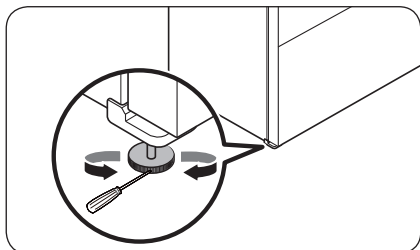

- To adjust the height of the left side: Insert a flat-head screwdriver into the leveler of the left side front leg. Turn the leveler clockwise to raise the left side or turn it counterclockwise to lower.
- To adjust the height of the right side: Insert a flat-head screwdriver into the leveler of the right side front leg. Turn the leveler clockwise to raise the right side or turn it counterclockwise to lower.

Installation

STEP 5 Adjust the door height

Adjusting the height with the height lever (applicable models only)

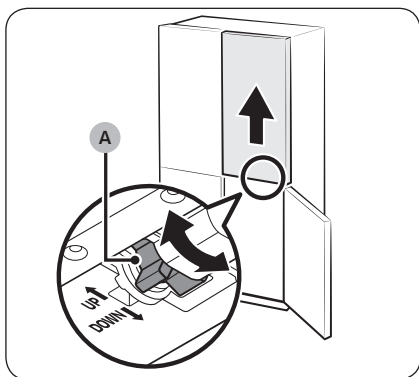
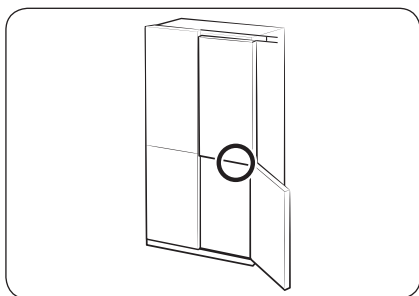

- Before aligning the door height, make sure the refrigerator is level. Use the leveling legs for this purpose.
- You can use the height lever at the bottom of the right-side door of the fridge. Open the right-side door of the freezer with both fridge doors closed and use the lever to adjust the door height.
- Turn the **height lever (A)** until the two doors are aligned at the top. Turn the lever toward **UP** (as marked) to raise the right-side door and turn it toward **DOWN** (as marked) to lower the door.
- Lift the fridge door slightly to make alignment easier. The maximum adjustable height is 3 mm.
 - The lever will not turn past the maximum limit. It may make a noise if it is turned too far.
 - Excessive height may interfere with the upper hinge cover of the fridge door.
- If you align the door height with the door bins empty and then store items in the bins, the heights may differ again. If this happens, follow the steps above to realign the doors.

Adjusting the height with the snap rings

For the models with the height lever on the right-side door of the fridge, use the snap rings only if you cannot align the doors with the height lever.

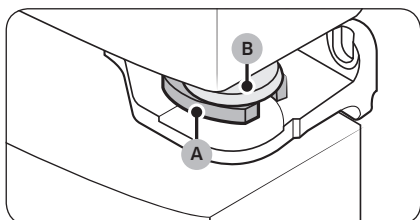
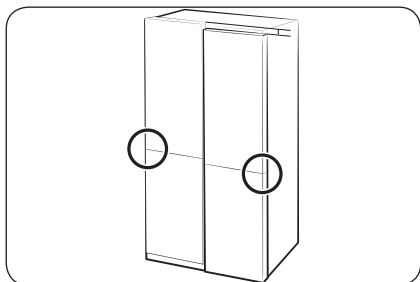
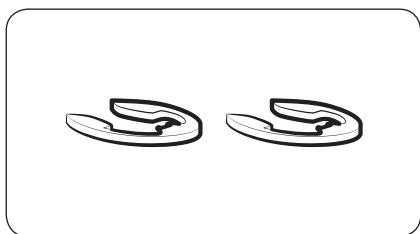

NOTE

The height of a door can be adjusted using the provided snap rings, which come in 4 different sizes (1 mm, 1.5 mm, 2 mm, and 2.5 mm).

1. Check the height difference between the doors, and then lift up and hold the door with the lower height.
2. Insert a suitable-sized snap ring (A) between the door grommet (B) and the hinge as shown.

CAUTION

- Insert only one snap ring. If you insert two or more snap rings, the rings may slip out or make a rubbing noise.
- Keep the snap rings out of children's reach and keep them for future use.
- Do not raise the door too much. The door can contact and damage the top cover.

Installation

Adjusting the freezer door height (applicable models only)

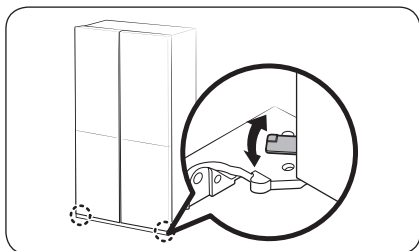

- Before aligning the door height, make sure the refrigerator is level. Use the leveling legs for this purpose.
- You can adjust the height of both freezer doors using the lever located at the bottom hinge.
- Open the door, lift it a little, and then turn the lever left or right to adjust the height.

Adjusting the gap between the fridge doors and the main body of the refrigerator (applicable models only)

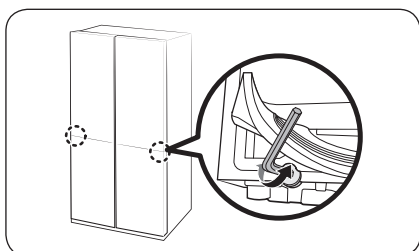

- You can adjust the gap between both fridge doors and the main body of the refrigerator using the adjustment bolt located at the bottom of the fridge compartment.
- Lift the door gasket and locate the adjustment bolt underneath the gasket. Use the 4 mm Allen wrench to adjust the gap.

⚠ CAUTION

Make sure you firmly attach the gasket. Otherwise, cold air from the refrigerator may leak.

Adjusting the gap between the doors and the main body of the refrigerator

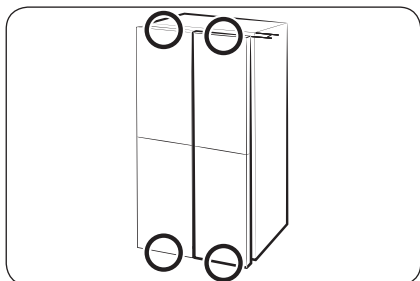

You can adjust the gap between all four doors and the main body of the refrigerator using the adjustment dial. (Refer to the figure for the location of the adjustment dial.)

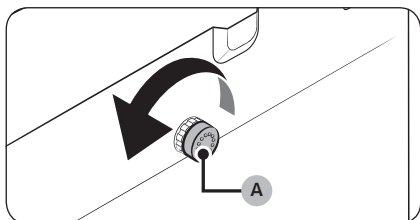

1. Open the door that is closer to the main body than the others. Then, turn the **adjustment dial (A)** counterclockwise until the gap becomes even with the others.

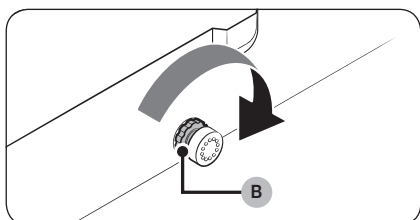

2. After adjusting the gap, turn the **locking nut (B)** to lock the adjustment dial.

NOTE

Each time you turn the **adjustment dial**, the gap is adjusted by 1 mm. However, the door may not close properly if you adjust the door by more than 1.5 mm.

Installation

STEP 6 Connect to a water source (applicable models only)

⚠ CAUTION

- The new hose-sets supplied with the appliance are to be used and that old hose-sets should not be reused.
- The water line must be connected by a qualified technician.
- The warranty for your refrigerator does not cover the water line installation. The water line installation will be performed at your own costs unless the installation fee is included in the retailer's price.
- Samsung takes no responsibility for the water line installation. If water leaks occur, contact the installer of the water line.

To connect the cold water pipe to the water filtering hose

⚠ CAUTION

- Make sure the water filtering hose is connected to a cold, potable water source pipe. Connecting to the hot water pipe may cause the purifier to malfunction.

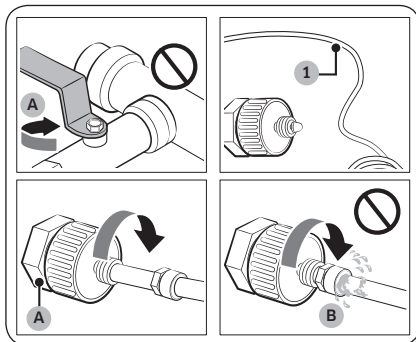

A. Close Main Water pipe

B. No gap

1. Shut off the water supply by closing the main water valve.
2. Locate the cold, potable water pipe (1).
3. Follow the Water Line Installation to connect to the water pipe.
4. When connection is complete, open the main water valve and dispense about 3 liters of water. This is to remove impurities inside the pipe.



To connect the water filtering hose to the water line

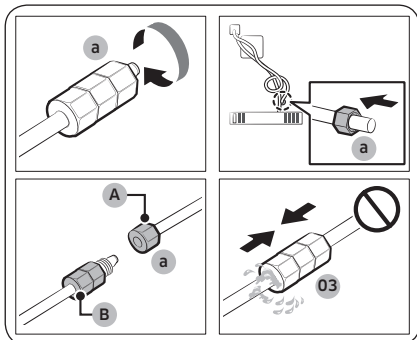

- A. Water Line from unit
- B. Water Line from Kit

1. Loosen and remove the **compression nut (a)** from the water line of the refrigerator, and insert it to the water filtering hose.
2. Tighten up the **compression nut (a)** to connect the water filtering hose and the water line.
3. Open the main water valve and check for any leaks.
4. If there are no leaks, dispense about a 3 liters of water before actually using the refrigerator to remove impurities inside the water filtering system.

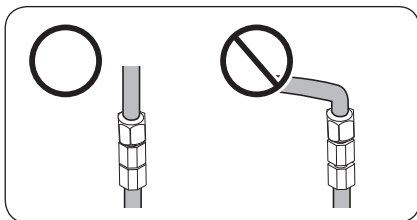

NOTE

If you have to relocate the refrigerator after connecting the **water line**, make sure the joined section of the water line must be straight.

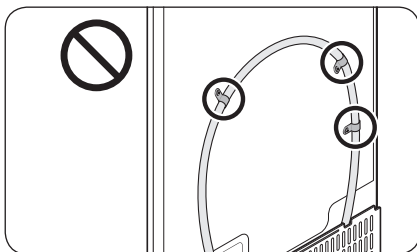

CAUTION

Do not mount the water filter on any part of the refrigerator. This may damage the refrigerator.

To repair the water line

CAUTION

The waterline must be repaired by a qualified professional. If you encounter a water leak, contact a local Samsung service centre or the installer of the waterline.



Installation

STEP 7 Initial settings

By completing the following steps, the refrigerator should be fully functioning.

1. Plug the power cord into the wall socket to turn the refrigerator on.
2. Open the door, and check if the interior light lights up.
3. Set the temperature to the coldest setting, and wait for about an hour. Then, the freezer will be slightly chilled, and the motor should be running smoothly.
4. Wait until the refrigerator reaches the set temperature. Now the refrigerator is ready for use.

STEP 8 Final check

When installation is complete, confirm that:

- The refrigerator is plugged into an electrical outlet and grounded properly.
- The refrigerator is installed on a flat, level surface with a reasonable clearance from walls and cabinets.
- The refrigerator is level and is sitting firmly on the floor.
- The door opens and closes freely, and the interior light turns on automatically when you open the door.

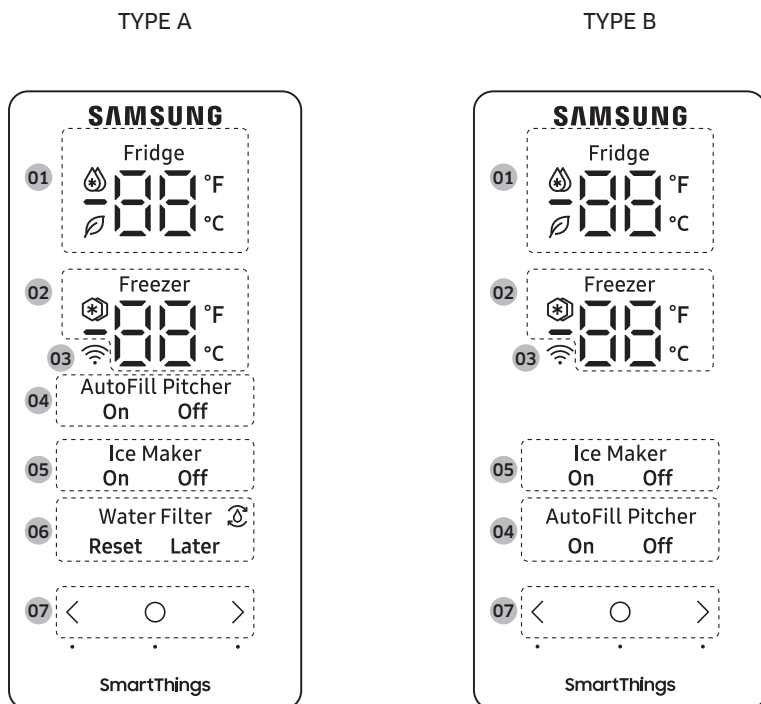

Operations

Main panel



01 Fridge indicator	<ul style="list-style-type: none"> Displays the current or desired temperature of the fridge. ☾ indicates that the Power Cool function is on. The 🌿 icon appears if you turn on the AI Energy Mode in the SmartThings app. (applicable models only)
02 Freezer indicator	<ul style="list-style-type: none"> Displays the current or desired temperature of the freezer. ❄️ indicates that the Power Freeze function is on.
03 Network connection indicator	<ul style="list-style-type: none"> This icon indicates that the refrigerator is connected to a network. If the Wi-Fi icon flashes, we recommend connecting your refrigerator with the SmartThings app. You can control and monitor your refrigerator on the SmartThings app. For more information, see the SmartThings section.

Operations

<p>04 AutoFill Pitcher indicator</p>	<p>The AutoFill Pitcher has 2 indicators (AutoFill Pitcher On / Off) to indicate its operating status.</p> <ul style="list-style-type: none"> • When the AutoFill operates, the corresponding indicator (AutoFill Pitcher On) turns on. • When the AutoFill is turned off, the corresponding indicator (AutoFill Pitcher Off) turns on. • To enable AutoFill Pitcher, you must turn on the AutoFill Pitcher.
<p>05 Ice Maker indicator</p>	<p>The ice maker has 2 indicators (Ice Maker On / Off) to indicate its operating status.</p> <ul style="list-style-type: none"> • When the ice maker operates, the corresponding indicator (Ice Maker On) turns on. • When the ice maker is turned off, the corresponding indicator (Ice Maker Off) turns on. • To enable ice making, you must turn the ice maker on.
<p>06 Water Filter indicator *</p>	<ul style="list-style-type: none"> •  indicates that the water filter needs to be replaced. • When see the  icon, you can replace the water filter and reset the water filter replace alarm, or dismiss the alarm and change the filter later. (For more information, see the "Resetting or dismissing the water filter replacement alarm" section on page 55.
<p>07 Buttons</p>	<ul style="list-style-type: none"> • When the display is off, tap any button to wake up the display. • Tap  to select the desired item on the main panel and to confirm any setting changes. • Tap < or > to change the settings of the selected item on the main panel.

* applicable models only

 **NOTE**

If the door is left open for 5 minutes, the internal light will blink for 5 minutes and turn off to alert deaf and hard of hearing users that a door is open. Note that this function is normal.

Setting the desired temperature or function

Select the fridge or freezer and set the desired temperature or function of your choice.

1. Tap any button (◀, ○, or ▶) to wake up the display.
 - This step may not apply to some models.
2. Tap ○ until the fridge or freezer indicator blinks.
 - The selected compartment's indicator blinks.
3. Tap < or > to select the desired temperature or function.
 - Refer to the table for available selection for each compartment.

Fridge	<ul style="list-style-type: none"> • Available selection (Celsius): 🧊 (Power Cool) ↔ 1 °C ↔ 2 °C ↔ 3 °C ↔ 4 °C ↔ 5 °C ↔ 6 °C ↔ 7 °C ↔ 🏖️ (Vacation) • Available selection (Fahrenheit): 🧊 (Power Cool) ↔ 34 °F ↔ 35 °F ↔ 36 °F ↔ 37 °F ↔ 38 °F ↔ 39 °F ↔ 40 °F ↔ 41 °F ↔ 42 °F ↔ 43 °F ↔ 44 °F ↔ 🏖️ (Vacation) • Power Cool speeds up the cooling process at maximum fan speed. The fridge keeps running at full speed for two and a half hours and then returns to the previous temperature.
Freezer	<ul style="list-style-type: none"> • Available selection (Celsius): ❄️ (Power Freeze) ↔ -23 °C ↔ -22 °C ↔ -21 °C ↔ -20 °C ↔ -19 °C ↔ -18 °C ↔ -17 °C ↔ -16 °C ↔ -15 °C • Available selection (Fahrenheit): ❄️ (Power Freeze) ↔ -8 °F ↔ -7 °F ↔ -6 °F ↔ -5 °F ↔ -4 °F ↔ -3 °F ↔ -2 °F ↔ -1 °F ↔ 0 °F ↔ 1 °F ↔ 2 °F ↔ 3 °F ↔ 4 °F ↔ 5 °F • Power Freeze speeds up the freezing process at maximum fan speed. • The freezer keeps running at full speed for 50 hours and then returns to the previous temperature. To freeze large amounts of food, activate Power Freeze for at least 20 hours before putting food in the freezer. <p>NOTE</p> <p>When you use this function, the energy consumption of the refrigerator will increase. Remember to turn it off when you do not need it and return the freezer to your original temperature setting.</p>

4. Wait for 5 seconds or tap ○ to confirm your selection.
 - The selected compartment's indicator stops blinking.

NOTE

- Using Power Cool or Power Freeze increases power consumption.
- When you change the temperature on the panel, the panel displays the actual temperature inside the refrigerator until the temperature matches the temperature you set. Then, the panel displays the new set temperature. Note that it will take time for the refrigerator to reach the new temperature. This is normal. During this time, you do not need to set the temperature again.
- To ensure optimal performance, we recommend setting the temperature to -18 °C for the freezer, and 3 °C for the fridge.

Operations

- The temperature in the refrigerator may rise if you open the door frequently or put a large amount of food into the refrigerator. If this happens, the temperature display blinks until the refrigerator returns to the specified temperature settings. If the blinking continues for an extended time, contact a local Samsung service center for technical assistance.
 - While the temperature display is blinking, an alarm may occur. To stop the alarm, tap any button on the display.
 - If you open the door while the temperature display is blinking, the internal light blinks for about a minute.

Turning on or off the AutoFill Pitcher

You can turn on or off the AutoFill Pitcher in fridge.

1. Tap any button (< , ○ , or >) to wake up the display.
 - This step may not apply to some models.
2. Tap ○ until the AutoFill Pitcher indicator blinks.
3. Tap < or > to turn on or off the AutoFill Pitcher.
 - Tap < to turn it on.
 - Tap > to turn it off.
4. Wait for 5 seconds or tap ○ to confirm your selection.
 - The AutoFill Pitcher indicator stops blinking.

Turning on or off the ice maker

You can turn on or off the auto ice maker in the freezer.

1. Tap any button (< , ○ , or >) to wake up the display.
 - This step may not apply to some models.
2. Tap ○ until the Ice Maker indicator blinks.
3. Tap < or > to turn on or off the ice maker.
 - Tap < to turn it on.
 - Tap > to turn it off.
4. Wait for 5 seconds or tap ○ to confirm your selection.
 - The Ice Maker indicator stops blinking.

Resetting or dismissing the water filter replacement alarm

The water filter replacement icon (⌘) blinks to alert the user that it is time to replace the water filter. You can replace the water filter immediately and reset the water filter replacement alarm, or dismiss the alarm if you want to change the water filter later.

1. Tap any button (< , ○ , or >) to wake up the display.
 - This step may not apply to some models.
2. Tap ○ until the Water Filter indicator blinks.
3. Tap < or > to select **Reset** or **Later**.
 - If you have changed the water filter, tap < to reset the water filter replacement alarm.
 - If you want to change the water filter later and dismiss the alarm, tap > .
4. Wait for 5 seconds or tap ○ to confirm your selection.
 - The Water Filter indicator stops blinking.

Operations

SmartThings

Installation

Visit the Google Play Store, Galaxy Apps, or Apple App Store and search for “SmartThings”. Download and install the SmartThings app provided by Samsung Electronics to your smart device.

NOTE

- The supporting software version of the SmartThings app is subject to change according to the OS supporting policy the manufacturer provides. In addition, as for the SmartThings app or the functions that the app supports, the new application update policy on the existing OS version can be suspended due to usability or security reasons.
- The SmartThings app is subject to change without notice to improve usability or performance. As the mobile phone OS version is updated every year, the SmartThings is also updated continually according to the latest OS. If you have enquiries regarding the items mentioned above, please contact us on st.service@samsung.com
- Recommended encryption systems include WPA/TKIP and WPA2/AES. Any newer or non-standard Wi-Fi authentication protocols are not supported.
- Wireless networks may be affected by the surrounding wireless communication environment.
- If your Internet service provider has registered the MAC address of your PC or modem for identification, your Samsung Smart Refrigerator may fail to connect to the Internet. If this happens, contact your Internet service provider for technical assistance.
- The firewall settings of your network system may prevent your Samsung Smart Refrigerator from accessing the Internet. Contact your Internet service provider for technical assistance. If this symptom continues, contact a local Samsung service center or retailer.
- To configure the wireless access point (AP) settings, see the user manual of the AP (router).
- Samsung Smart Refrigerators support both Wi-Fi 2.4 GHz with IEEE 802.11 b/g/n and Soft-AP protocols. (IEEE 802.11 n is recommended.)
- Unauthorized Wi-Fi wireless routers may fail to connect to applicable Samsung Smart Refrigerators.

Samsung account

You are required to register your Samsung account to use the app. If you don't have a Samsung account, follow the app's onscreen instructions to create a free Samsung account.

Getting started

Turn on the device you want to connect, open the SmartThings app on your phone, and then follow the instructions below.

If a pop-up appears saying that a new device has been found, tap **ADD NOW**.

If a pop-up doesn't appear, tap the **+** button, and then select the device you want to connect from the list of available devices.

If your device isn't in the list of available devices, tap **Supported Devices**, select the device type (Refrigerator), and then select the specific device model.

Follow the instructions in the app to set up your device. Once setup is complete, your refrigerator will appear as a "card" on your **Devices** screen.

Refrigerator app

Integrated control

You can monitor and control your refrigerator at home and on the go.

- Tap the refrigerator icon on the SmartThings Dashboard or tap the Devices icon at the bottom of the Dashboard, and then tap the refrigerator "card" to open the Refrigerator page.
- Check the operation status or notifications related to your refrigerator, and then change options or settings if necessary.

NOTE

Some options or settings of the refrigerator may not be available for remote control.

Operations

Category	Item	Description
Monitor & Control	Fridge Temperature	You can set and monitor the desired temperature of the fridge.
	Freezer Temperature	You can set and monitor the desired temperature of the freezer.
	Power Cool	You can turn Power Cool on or off, and check the current settings.
	Power Freeze	You can turn Power Freeze on or off, and check the current settings.
	Ice Making	You can turn the ice making function on or off, and check the current settings of the function.
	AutoFill Pitcher	You can turn the AutoFill Pitcher function on or off, and check the current settings of the function.
Alarms	Abnormally high temperature	This alarm is triggered when the fridge, or the freezer has abnormally high temperatures.
	Door opening	This alarm is triggered if the fridge door, or the freezer drawer is open for a specific time.
	AutoFill Pitcher overflowing	If the AutoFill Pitcher function senses an overflow, it triggers this alarm to let you know the status of the overflow.
AI Energy Mode (applicable models only)	<p>You can turn on or off the AI Energy Mode under the Energy menu in the SmartThings app.</p> <p>You can check the status of the AI Energy Mode on the SmartThings app.</p> <p>On some models, the  icon appears on the main panel to indicate that AI Energy Mode is on. (applicable models only)</p> <p>Turning on the AI Energy Mode decreases energy consumption, but it may also reduce the cooling performance.</p>	

Special features

Water pitcher (AutoFill Pitcher) (applicable models only)

Cold, purified water is always ready in the AutoFill Pitcher. You can put tea or fruits in the infuser to enjoy the various infused water you like.

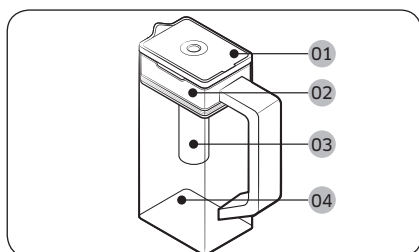

- 01 Lid
- 02 Infuser holder
- 03 Infuser
- 04 Body

To fill the Water pitcher

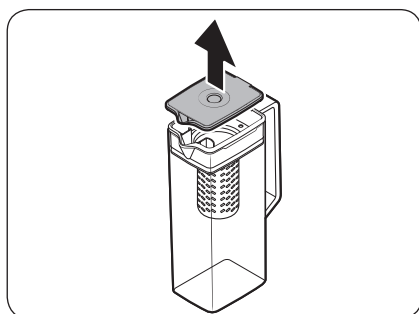

1. Grasp a handle groove of the **lid**, and then pull up to open the **lid**.
2. Put tea leaves or fruit to your taste into the infuser.

NOTE

If you want to keep the infused water in its initial concentration, turn the AutoFill Pitcher function off.

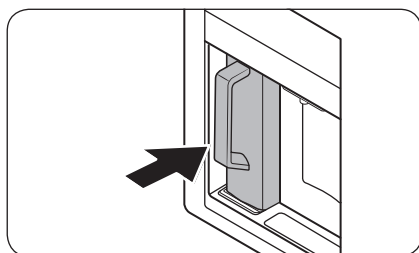

3. Enable the AutoFill Pitcher function on the main panel. Open the Beverage Center door, and then mount the water pitcher onto the holder. Push it straight in as shown in the figure.
4. Close the door. The water pitcher will start to fill with chilled water a short time later.

CAUTION

Make sure the water pitcher fits in the water pitcher holder.

Operations

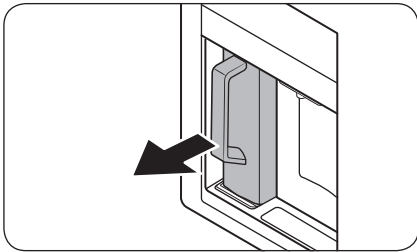

5. To drink tea, open the Beverage Center door, and then detach the water pitcher. Pull it straight out.

⚠ CAUTION

- We recommend consuming fruit infused water within 24 hours. After that, the infused water can spoil over time.
- You must clean the water pitcher after you have consumed the infused water. Also clean the water pitcher if you haven't used it for a long time.

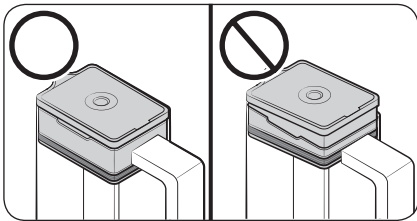

- To prevent the water pitcher from spilling over or leaking, make sure the infuser holder is properly inserted.

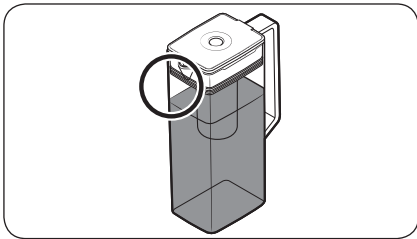

📖 NOTE

- If the front side (specifically marked area) of the water pitcher has too much moisture, the water pitcher may not fully fill. Remove the moisture, and then try again.
- AutoFill Pitcher function will stop supplying water to the water pitcher if the water pitcher does not fill after a certain amount of time. If this happens, check if the water line is properly connected. Remove and reinsert the water pitcher, and then try again.

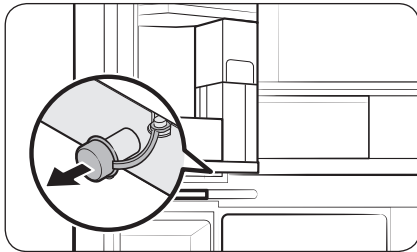

NOTE

- Wipe around the water pitcher holder if the water pitcher overflows or leaks.
- Water drops off if the rubber cap is opened.
- An alert appears on the main panel if there is a leak. In case of a leak, open the rubber cap so that the leaked water drains. If the alert does not disappear after draining, there might be a system failure. Contact your local Samsung service center.

Water dispenser (applicable models only)

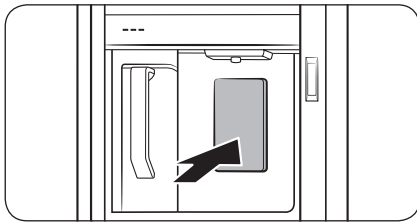

To dispense chilled water, open the Beverage Center and press the dispenser lever.

NOTE

- The dispenser will stop dispensing if you keep pushing the dispenser lever for about 1 minute. To dispense more water, release and push the lever again.
- Make sure the glass is in line with the dispenser to prevent the dispensed water from spilling out.
- If you do not use the water dispenser for 2-3 days, the dispensed water may have an abnormal smell or taste. This is not a system failure. Discard the first 1-2 glasses of water.

Water clouding

Water supplied to the refrigerator flows through a core alkaline filter. During this filtering process, the water pressure of the water increases and the water becomes saturated with oxygen and nitrogen. This causes the water to look misty or cloudy temporarily when dispensed. This is normal and the water will look clear after a few seconds.

Operations

Auto Ice maker (applicable models only)

The refrigerator has a built-in ice maker that automatically dispenses ice.

- The overall design and/or accessories may differ with the model.

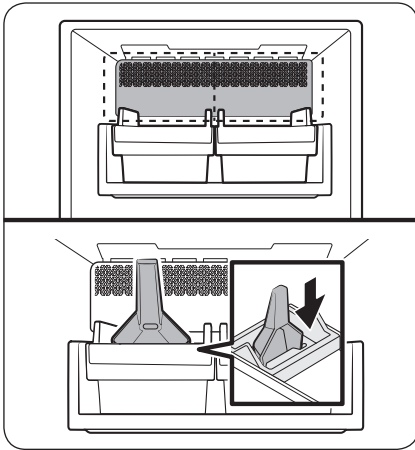

- This product has two types of ice makers.

Ice making

After you have installed your refrigerator and plugged it in, follow these instructions to ensure proper ice making and to keep the ice bucket full of ice.

For first-time use

- Let the ice maker make ice for 1-2 days.
- Discard the first 1-2 buckets of ice to remove impurities in the water supply system.

Diagnosis

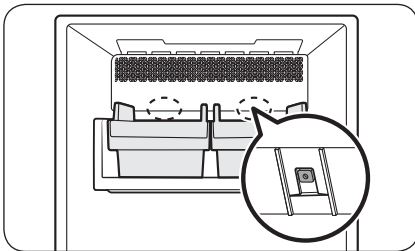

- The overall design and/or accessories may differ with the model.
- If ice does not dispense, first check the status of ice maker using the **Test** button on the bottom of the ice maker.
- Press the **Test** button on the back of the ice maker. You will hear a chime (ding-dong) when you press the button. You will hear another chime if the ice maker is operating properly.

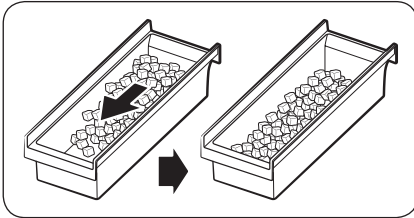

- Ice accumulating on one side of the tray is normal. Arrange the ice evenly in the tray to store more ice.

⚠ CAUTION

- Leaving the water line disconnected may cause the water valve to produce a buzzing sound over time. If this is the case, make sure to turn the ice making function off.
- If the ice making chime rings repeatedly, contact the waterline installer or a local Samsung service center.
- Do not put food in the ice bucket. The frozen food may damage the ice maker, especially when you open or close the door.
- When the refrigerator recovers power after a power failure, the ice bucket may contain a mix of melted and jammed ice cubes, which can prevent the ice maker from working properly. To prevent this, make sure to empty the ice bucket before using the refrigerator.
- Do not put fingers or any objects into the ice maker. This can cause physical injury or property damage.
- Due to sublimation, ice stored in the freezer for a long time gets smaller and then forms large ice chunks. Therefore, if it will be a long time before you use ice, turn the ice maker off as follows.
- Use the new hose-sets supplied with the appliance only. Do not re-use an old hose set.

Operations

Water tank (applicable models only)

You can add drinking water to make ice.

⚠ CAUTION

- Fill the tank only with potable water such as mineral or purified water. Do not use other liquid.
- Full water tank is heavy and therefore, use caution when moving a filled tank. Physical injury may occur if the tank is dropped.
- After the initial installation, the water tank must be filled to supply water to the AutoFill pitcher.
- Regularly check and fill the water tank as it is the water source for the AutoFill pitcher and the ice maker.

To fill the water tank

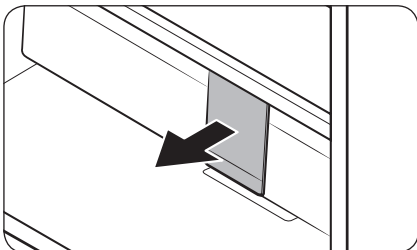

For first-time use, clean the inner side of the water tank and dry well.

1. Open the refrigerator door and pull out the water tank to take it out.

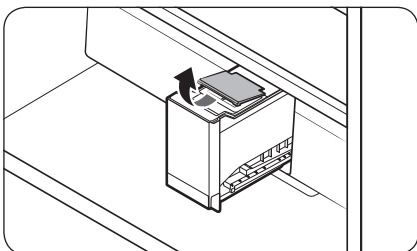

2. Open the front lid and add water according to the marks in the water tank.

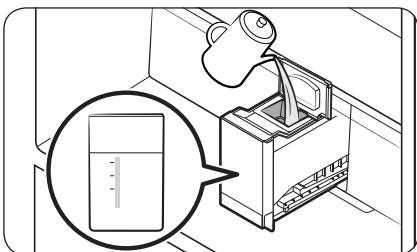

⚠ CAUTION

Do not exceed the max line. Water overflows.

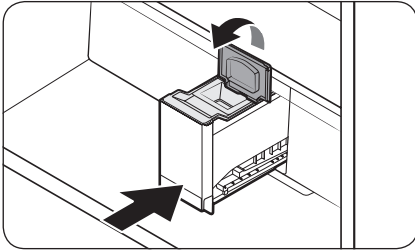

- Close the front lid and push the water tank all the way in. Turn the Ice Maker On in the main panel. Ice that is made will be stored in the freezer's ice bucket.

NOTE

- Even if the water tank is full, ice will not be made if the Ice Maker is turned off.
- The pump that sends water to the Ice Maker may make noise if the water tank is empty. Turn off the Ice Maker to avoid this.
- There may be noise for about 5 seconds when sending water to the Ice Maker. This is normal and is not a malfunction.

CAUTION

- Do not put water directly in the ice bucket to freeze it. There is a risk of damage.
- Empty the water tank when it is not in use.
- When the refrigerator recovers power after a power failure, the ice bucket may contain a mix of melted and jammed ice cubes, which can prevent the ice maker from working properly. To prevent this, make sure to empty the ice bucket before using the refrigerator.
- Do not put fingers or any objects into the ice maker. This can cause physical injury or property damage.

Cleaning and maintenance

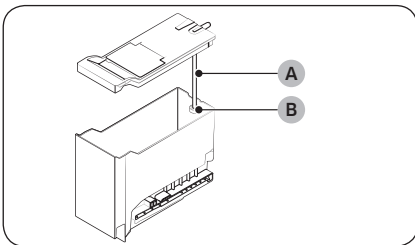

- Clean the water tank every one or two weeks. Be sure to detach every component part including the cover and the **nozzle (A)**.
- Completely empty the water tank before cleaning with clean water. And dry out the tank for later use.
- Use a soft brush to clean the **filter (B)**.

CAUTION

Do not leave the water tank with moisture inside before refilling with water. Otherwise, the tank may have impurities built up inside over time.

Maintenance

Handling and care

Ice bucket (applicable models only)

If you do not dispense ice for an extended period, ice may form clumps inside the bucket. If this happens, remove and empty the ice bucket.

⚠ CAUTION

- To prevent injury, make sure to clean up any ice or water that has fallen on the floor.
- To prevent accidents or injury, do not let children play with the water dispenser or the ice maker.
- Use only the provided ice bucket. Third-party ice buckets may cause a system failure.

📄 NOTE

- The water pressure required for ice making is between 206-861 kPa.
- Noise from the ice maker as it produces ice during the ice making process is normal.

AutoFill Pitcher

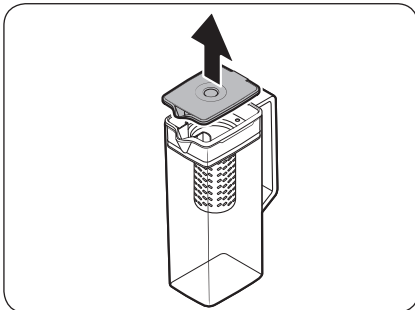

1. Grasp a handle groove of the lid, and then pull up to remove.

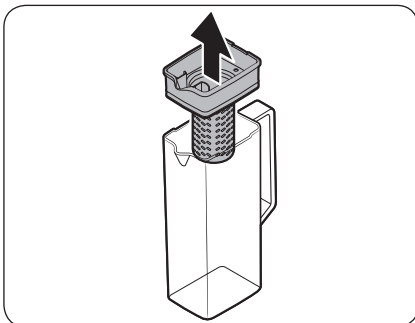

2. Grasp both sides of the infuser holder, and then lift to remove.

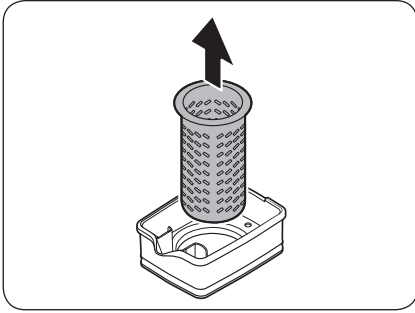

3. While slightly twisting the **infuser**, pull it out of the sealed mouth.
4. Clean the **infuser** with neutral agents and running water. Rinse and dry well.
5. Reassemble the AutoFill Pitcher in the reverse order of disassembly.

⚠ CAUTION

The water pitcher and lid are not microwave safe and can melt or deform if exposed to heat (including hot water). Please hand wash in cool or warm water as needed.

Maintenance

Fridge shelves

The appearance of the shelves differs by model.

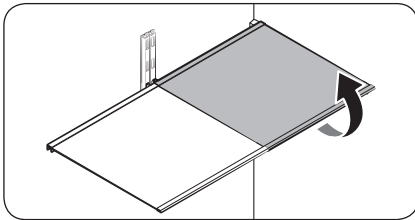

- To remove a shelf, fully open the corresponding door. Hold the front of the shelf, and then gently lift up and pull out.

NOTE

Do not lift up the shelf fully when removing or reinserting the shelf. The rear wall of the fridge room can be dented.

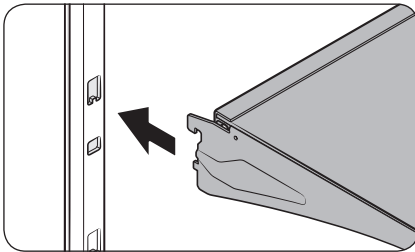

- To reinsert, hold the shelf at an angle so the front is higher than the back, and then insert the top hook into the top shelf notch. Then, lower the shelf and insert the bottom shelf hook into the bottom shelf notch.

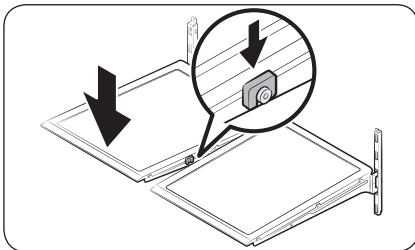

CAUTION

- The tempered glass shelves are heavy. Use caution when removing them.
- The shelf must be inserted correctly. Do not insert upside down.
- Glass containers may scratch the surface of glass shelves.

Door bins

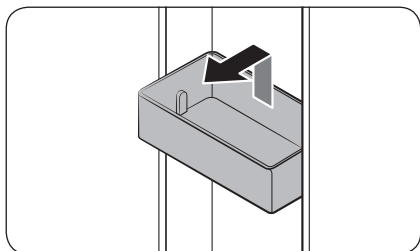

- To remove the **door bin**, hold the front sides of the bin, and then gently lift up to remove.
- To reinsert, insert the **door bin** slightly above its final location making sure that the back of the bin is against the door. Hold the rear of the **door bin** with both hands, and then press down so that it fits snugly.

⚠ CAUTION

- Do not remove a bin that is filled with food. Empty the bin beforehand.
- Use caution when opening the door if the bottom bin contains larger bottles, which may fall over.
- Do not allow children to play with the bins. Sharp corners of the bins may cause injury.

Fridge drawers

Crisper / Flex Crisper Drawers (applicable models only)

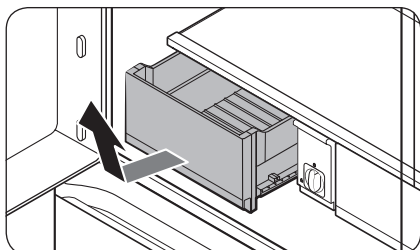

Gently lift up the front of the drawer and slide out.

- We recommend that you remove the door bins before removing the drawer. This is to prevent damage to the door bins.
- To reinsert, insert the drawer into the frame rails and then slide inward.

Maintenance

Cleaning

Interior and exterior

⚠ WARNING

- Do not use benzene, thinner, home/car detergent, or Clorox™ to clean the refrigerator. They may damage the surface of the refrigerator and cause a fire.
- Do not spray water onto the refrigerator. This may cause electric shock.

Regularly use a dry cloth to remove all foreign substances such as dust or water from the power plug terminals and contact points.

1. Unplug the power cord.
2. Use a moistened, soft, lint-free cloth or paper towel to clean the refrigerator's interior and exterior.
3. When done, use a dry cloth or paper towel to dry well.
4. Plug in the power cord.

Dispenser cock (applicable models only)

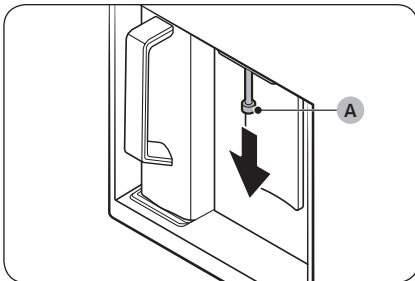

1. Hold the end of the dispenser cock (A).
2. While turning the dispenser cock (A) left, pull it down to remove it from the dispenser.

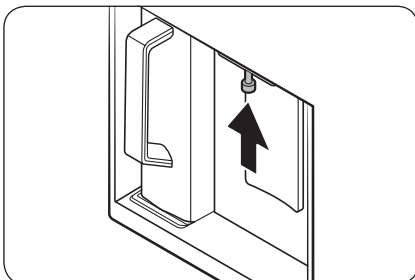

3. Clean the dispenser cock thoroughly, and then assemble it back.

⚠ CAUTION

- Fully insert the dispenser cock, so it is back to its original position.
- Do not use a scrub with rough textures for cleaning the dispenser cock.



Rubber seals

If the rubber seals of a door become dirty, the door may not close properly and reducing refrigerator performance and efficiency. Use a mild detergent and damp cloth to clean the rubber seals. Then, dry well with a cloth.

Rear panel

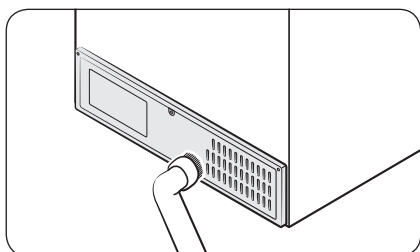

To keep cords and exposed parts of the rear panel free of dirt, vacuum the panel once or twice a year.

⚠ CAUTION

Do not remove the rear panel cover. Electric shock may occur.

Replacement

Water filter (applicable models only)

⚠ WARNING

- Do not use third-party water filters. Use only Samsung-provided or -approved filters.
- Unapproved filters may leak and damage the refrigerator, causing electric shock. Samsung is not responsible for any damage that may occur from use of third-party water filters.

The water filter replacement icon (🔄) blinks to let you know it is time to replace the water filter. Before replacing the filter, make sure the water supply line is shut off.

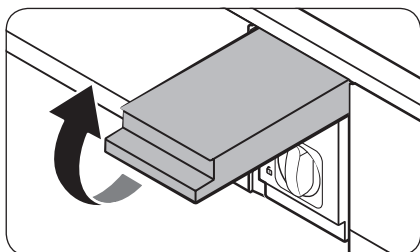

1. Shut off the water supply line.
2. Open the filter cartridge cover.



Maintenance

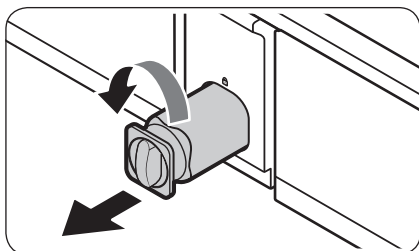

3. Turn the knob of the filter cartridge counter clockwise 90 degrees ($\frac{1}{4}$ turn). The filter cartridge unlocks.

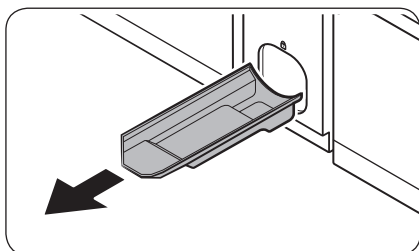

4. Pull out to remove the cartridge.
 - If the water filter is severely contaminated, the cartridge may not be easy to remove. If that is the case, use force to remove the cartridge.
 - To prevent water leaks from the filter opening, pull the cartridge straight out while removing it.

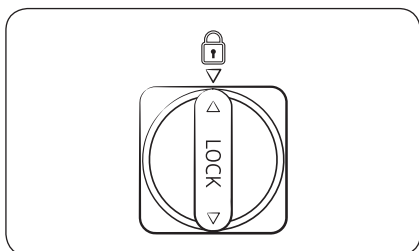

5. Insert a new filter cartridge. Use only Samsung-provided or approved filters.
6. Turn the cartridge knob clockwise to lock into place.
7. Close the filter cartridge cover.
8. Reset the water filter replacement alarm. (For detailed instructions, see the "Resetting or dismissing the water filter replacement alarm" section on page 55.)

NOTE

- A newly installed filter may cause the water dispenser to spurt water briefly. This is because air has entered the waterline.
- The replacement process may cause the water dispenser to drip for a short period of time. If it drips, simply wipe up any water on the floor with a dry towel.



Reverse osmosis water filtration system

The water pressure of the water supply system to a reverse osmosis water filtration system must be between 206-861 kPa.

The water pressure of the reverse osmosis water filtration system to the refrigerator's cold water line must be at least 206 kPa. If the water pressure is below these specifications:

- Check if the sediment filter in the reverse osmosis system is blocked. Replace the filter if necessary.
- Refill the water tank in the reverse osmosis system with water.
- If your refrigerator has a water filter, it may further reduce the water pressure when used in conjunction with a reverse osmosis system. Remove the water filter.

For more information or servicing, contact a licensed plumbing professional.

Ordering a new filter

To purchase a new water filter, contact a local Samsung service center.

LED Lamps

To replace the lamps of the refrigerator, contact a local Samsung service center.

WARNING

- The lamps are not user-serviceable. Do not attempt to replace a lamp yourself. This can cause electric shock.

Door panel

You can select the door panel you prefer for your BESPOKE refrigerator. Purchase the door panel at a Samsung retail store or Samsung website (www.samsung.com), and an authorised installer will install the panel for you. (Available place to purchase the door panel may vary depending on the country.)

CAUTION

- Disassembling or assembling the door panel on your own may result in product damage or personal injury. If you find any problems with the door panel, contact a Samsung service centre.
- A service fee may be charged for panel replacement even within the warranty period.



Troubleshooting

Before calling for service, review the checkpoints below. Any service calls regarding normal situations (No Defect Cases) will be charged to users.

General

Temperature

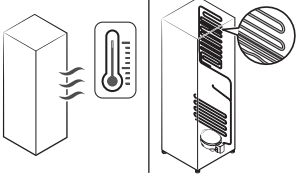
Symptom	Possible causes	Solution
Fridge/freezer does not operate. Fridge/freezer temperature is warm.	<ul style="list-style-type: none"> Power cord is not plugged in properly. 	<ul style="list-style-type: none"> Properly plug in the power cord.
	<ul style="list-style-type: none"> Temperature control is not set correctly. 	<ul style="list-style-type: none"> Set the temperature lower.
	<ul style="list-style-type: none"> Refrigerator is located near a heat source or direct sunlight. 	<ul style="list-style-type: none"> Keep the refrigerator away from direct sunlight or a heat source.
	<ul style="list-style-type: none"> Not enough clearance between refrigerator and nearby walls or cabinets. 	<ul style="list-style-type: none"> Make sure there is a gap of at least 5 cm between the refrigerator back and sides and any nearby walls or cabinets.
	<ul style="list-style-type: none"> The refrigerator is overloaded. Food is blocking the refrigerator vents. 	<ul style="list-style-type: none"> Do not overload the refrigerator. Do not allow food to block vents.
Fridge/freezer is over-cooling.	<ul style="list-style-type: none"> Temperature control is not set correctly. 	<ul style="list-style-type: none"> Set the temperature higher.
Interior wall is hot.	<ul style="list-style-type: none"> Refrigerator has heat-proof piping in the interior wall. 	<ul style="list-style-type: none"> To prevent condensation from forming, the refrigerator has heat-proof piping in the front corners. If the ambient temperature rises, this equipment may not work effectively. This is not a system failure. 

Odors

Symptom	Possible causes	Solution
Refrigerator has odors.	• Spoiled food.	• Clean the refrigerator and remove any spoiled food.
	• Food with strong odors.	• Make sure strong smelling food is wrapped airtight.

Frost

Symptom	Possible causes	Solution
Frost around the vents.	• Food is blocking the vents.	• Make sure no food blocks the refrigerator vents.
Frost on interior walls.	• Door is not closed properly.	• Make sure food does not block the door. Clean the door gasket.

Condensation

Symptom	Possible causes	Solution
Condensation forms on the interior walls.	• If door is left open, moisture enters the refrigerator.	• Remove the moisture and do not leave a door open for extended periods of time.
	• Food with high moisture content.	• Make sure food is wrapped airtight.

Troubleshooting

Water/ice (dispenser models only)

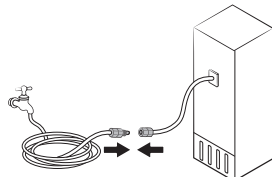
Symptom	Possible causes	Solution
Water flow is weaker than normal.	<ul style="list-style-type: none"> Water pressure is too low. 	<ul style="list-style-type: none"> Make sure the water pressure is between 206-861 kPa.
Ice maker makes a buzzing sound.	<ul style="list-style-type: none"> The ice maker function is activated, but the water supply to the refrigerator has not been connected. 	<ul style="list-style-type: none"> Turn off the Ice Maker.
Ice maker does not make ice.	<ul style="list-style-type: none"> Ice maker has just been installed. 	<ul style="list-style-type: none"> You must wait for 12 hours for the refrigerator to make ice.
	<ul style="list-style-type: none"> Freezer temperature is too high. 	<ul style="list-style-type: none"> Set the freezer temperature below -18 °C or -20 °C in warm ambient air.
	<ul style="list-style-type: none"> Ice maker is off. 	<ul style="list-style-type: none"> Turn on the ice maker.
Ice does not dispense.	<ul style="list-style-type: none"> Ice may jam if the ice dispenser is not used for a long time (approx. 3 weeks). 	<ul style="list-style-type: none"> If you won't be using the refrigerator for a long time, empty the ice bucket and turn off the ice maker.
	<ul style="list-style-type: none"> Ice bucket is not properly inserted. 	<ul style="list-style-type: none"> Make sure the ice bucket is properly inserted.
	<ul style="list-style-type: none"> Water line is not connected properly or water supply is not on. 	<ul style="list-style-type: none"> Check the water installation conditions. 

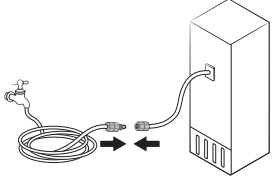
Symptom	Possible causes	Solution
Water does not dispense.	<ul style="list-style-type: none"> Water line is not connected properly or water supply is not on. 	<ul style="list-style-type: none"> Check the water installation conditions. 
	<ul style="list-style-type: none"> A third-party water filter was installed. 	<ul style="list-style-type: none"> Use only Samsung-provided or approved filters. Unapproved filters may leak and damage the refrigerator.
	<ul style="list-style-type: none"> The "Replace water filter" message appears on the main panel. 	<ul style="list-style-type: none"> Replace the water filter. Then, reset the water filter replacement alarm. (For detailed instructions, see the "Resetting or dismissing the water filter replacement alarm" section on page 55.)

Troubleshooting

Do you hear abnormal sounds from the refrigerator?

Before calling for service, review the checkpoints below. Any service calls related to normal sounds will be charged to the user.

These sounds are normal.

- When starting or ending an operation, the refrigerator may make sounds similar to a car engine igniting. As the operation stabilizes, the sounds will decrease.

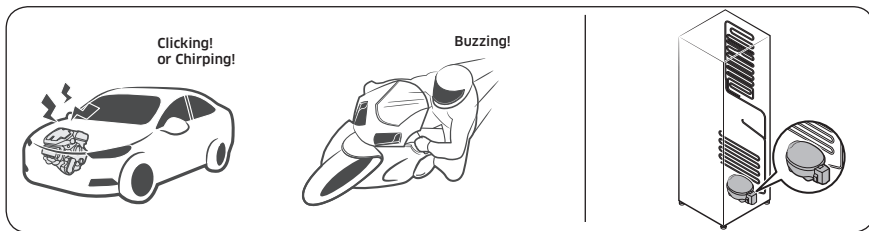

- While the fan is operating, these sounds may occur. When the refrigerator reaches the set temperature, no fan sound will occur.

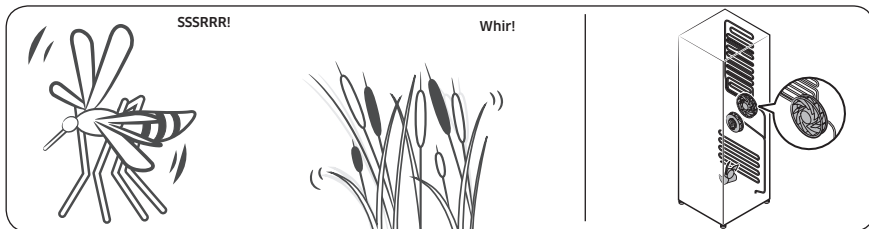

- During a defrost cycle, water may drip on the defrost heater, causing sizzling sounds.



- As the refrigerator cools or freezes, refrigerant gas moves through sealed pipes, causing bubbling sounds.

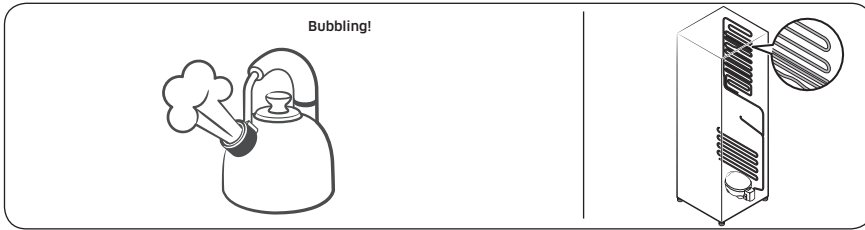

- As the refrigerator temperature increases or decreases, plastic parts contract and expand, creating knocking noises. These noises occur during the defrosting cycle or when electronic parts are working.

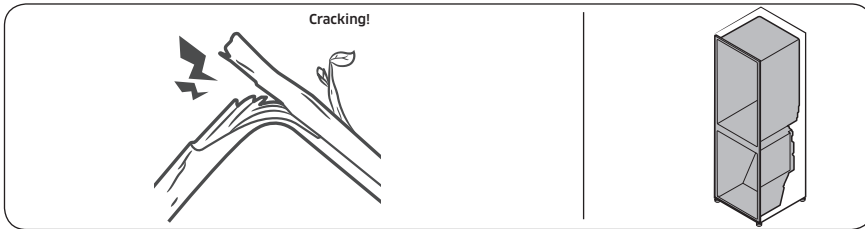

- For ice maker models: When the water valve opens to fill the ice maker, buzzing sounds may occur.
- Because of pressure equalizing when opening and closing the refrigerator door, whooshing sounds may occur.

Troubleshooting

SmartThings

Symptom	Action
Could not find "SmartThings" in the app market.	<ul style="list-style-type: none">The supporting software version of the SmartThings app is subject to change according to the OS supporting policy the manufacturer provides. In addition, as for the SmartThings app or the functions that the app supports, the new application update policy on the existing OS version can be suspended due to usability or security reasons.
The SmartThings app fails to operate.	<ul style="list-style-type: none">The SmartThings app is available for applicable models only.The old Samsung Smart Refrigerator app cannot connect with Samsung Smart Home models.
The SmartThings app is installed but is not connected to my refrigerator.	<ul style="list-style-type: none">You must log into your Samsung account to use the app.Make sure that your router is operating normally.If the Wi-Fi icon on the refrigerator's display is off, this indicates that no network connection has been established yet. In this case, use the SmartThings app to connect and register your refrigerator to the access point (AP) of your house.
Could not log into the app.	<ul style="list-style-type: none">You must log into your Samsung account to use the app.If you don't have a Samsung account, follow the app's onscreen instructions to create one.
An error message appears when I try to register my refrigerator.	<ul style="list-style-type: none">Easy Connection may fail due to the distance from your access point (AP) or electrical interference from the surrounding environment. Wait a moment and try again.
The SmartThings app is successfully connected to my refrigerator but does not run.	<ul style="list-style-type: none">Exit and restart the SmartThings app, or disconnect and reconnect the router.Power off the refrigerator, and then power it on again after 1 minute.
The Wi-Fi icon is blinking. ()	<ul style="list-style-type: none">Connect your refrigerator with the SmartThings app before use. When the connection is made successfully, the indicator stops blinking.<ul style="list-style-type: none">If you fail to make connection or don't want to use the app, press and hold the > button for 10 seconds. The indicator stops blinking with "O FF" shown on the temperature display.

Open Source Announcement

The software included in this product contains open source software.

The following URL http://opensource.samsung.com/opensource/SMART_TP1_0/seq/0 leads to open source license information as related to this product.



Memo

Memo

Contact SAMSUNG WORLD WIDE

If you have any questions or comments relating to Samsung products, please contact the SAMSUNG customer care centre.

Country	Contact Center	Web Site
AUSTRALIA	1300 362 603 (Other) 1300 425 299 (HHP)	www.samsung.com/au/support
NEW ZEALAND	0800 726 786 (All Product) 0800 6 726 786 (Support for Smart Mobile Devices)	www.samsung.com/nz/support



DA68-04604D-00