



Scan the QR code to see the manual.



OWNER'S MANUAL

VACUUM CLEANER



Before beginning installation, read these instructions carefully. This will simplify installation and ensure that the product is installed correctly and safely. Leave these instructions near the product after installation for future reference.

ENGLISH

A9X-ULTRA2 / A9X-AUTO2 / A9X-ULTRA2G



MFL05759004
Rev.00_020625

www.lg.com

Copyright © 2025 LG Electronics. All Rights Reserved

TABLE OF CONTENTS

This manual may contain images or content that may be different from the model you purchased.
This manual is subject to revision by the manufacturer.

SAFETY INSTRUCTIONS

READ ALL INSTRUCTIONS BEFORE USE..... 3
WARNING 3
CAUTION 10

INSTALLATION

Product Overview..... 12
Storing the Accessories 15

OPERATION

Getting Started 18
Charging the Battery 22
Using the Mop Nozzle 24
Using the Nozzles and Tools..... 28

SMART FUNCTIONS

Using LG ThinQ Application 31
Smart Diagnosis Function 33

MAINTENANCE

Cleaning the Appliance 34
Cleaning the Nozzles 38

TROUBLESHOOTING

Before Calling for Service 41

SAFETY INSTRUCTIONS

READ ALL INSTRUCTIONS BEFORE USE

The following safety guidelines are intended to prevent unforeseen risks or damage from unsafe or incorrect operation of the appliance. The guidelines are separated into '**WARNING**' and '**CAUTION**' as described below.

Safety Messages



This symbol is displayed to indicate matters and operations that can cause risk. Read the part with this symbol carefully and follow the instructions in order to avoid risk.



WARNING

This indicates that the failure to follow the instructions can cause serious injury or death.



CAUTION

This indicates that the failure to follow the instructions can cause the minor injury or damage to the product.

WARNING

WARNING

- To reduce the risk of explosion, fire, death, electric shock, injury or scalding to persons when using this product, follow basic precautions, including the following:

Technical Safety

- This appliance is not intended for use by persons (including children) with reduced physical, sensory or mental capabilities, or lack of experience and knowledge, unless they have been given supervision or instruction concerning use of the appliance by a person

responsible for their safety. Children should be supervised to ensure that they do not play with the appliance.

- Do not allow the appliance to be used as a toy. Close attention is necessary when used by or near children.
- Do not allow children to play with or hang on the appliance.
- Do not use the appliance with damaged power cord or plug. The cord must be replaced. If the appliance is not working as it should, has been dropped, damaged, left outdoors, or dropped into water, return it to an LG Electronics service centre.
- Do not pull or carry by cord, use cord as a handle, close a door on cord, or pull cord around sharp edges or corners. Do not run appliance over cord. Keep cord away from heated surfaces.
- Do not unplug by pulling on cord. To unplug, grasp the plug, not the cord.
- Place the cords from other appliances out of the area to be cleaned.

Battery

- Never use the battery, adapter, and the charging station from other appliances with this appliance. Use only the battery and the charging station provided by LG Electronics.
- Never use the battery, adapter, and the charging station from this appliance with other appliances.
- Unplug the power cord and remove the battery if the appliance will not be used for an extended period of time.
- Do not use modified or damaged batteries.
- Do not disassemble, remove or short-circuit the battery.
- When disposing of the battery or the appliance, remove the battery from the appliance and safely dispose of it.
- Have specifically designated battery packs replaced when it is no longer able to hold a charge.
- Refer to the **Charging the Battery** section instructions for the method of replacing the battery.

- When disposing of this appliance, follow regulations for disposal of rechargeable lithium-ion batteries.
- Follow all local ordinances and regulations when handling or disposing of the battery.
- Prevent unintentional starting. Ensure the switch is in the off position before connecting to the battery pack, picking up or carrying the appliance.
- Disconnect the battery pack from the appliance before making any adjustments, changing accessories, cleaning, serving, or storing appliance.
- When battery pack is not in use, keep it away from other metal objects, like paper clips, coins, keys, nails, screws or other small metal objects, that can make a connection from one terminal to another.
- Under abusive conditions, liquid may be ejected from the battery. If this happens, avoid contact. If contact accidentally occurs, flush with water. If liquid contacts eyes, additionally seek medical help.
- If the appliance is to be stored unused for a long period, the batteries should be removed.
- Before removing the battery, you must turn off this appliance.
- When fitting the battery into the product body, insert it completely until it clicks.
- Batteries with spilled electrolyte must be disposed of by qualified recycling organizations at the time of disposal.

Battery Specifications

- One or two batteries are provided, the number of batteries varies depending on the model purchased.
 - **Battery Model Name:** EAC633822**
 - **Type:** Rechargeable Lithium-ion Battery
 - **Rated Capacity:** 2400 mAh

Installation

- To avoid an electrical shock or fire, do not install, charge or store the appliance where it may be exposed to water, rainfall or high humidity.
- Install, charge and store the appliance in a well-ventilated place.
- Avoid operating the appliance in areas where there is a risk of leakage of flammable gas, industrial oil or metallic dust.
- Do not store or install the appliance, power cord or plug near heating devices or open flames.
- Install the charging station on a firm, level surface.
- Do not use or store the appliance at temperatures below 5 °C or above 38 °C.
- Do not store or install the appliance where it is exposed to temperatures below freezing or exposed to outdoor weather conditions.
- When installing or moving the appliance, be careful not to pinch, crush, or damage the power cord or plug.

Operation

- Read all instructions before using the appliance, and save these instructions.
- Use only as described in this manual. Use only manufacturer's recommended attachment.
- This appliance is designed for normal indoor domestic use only. It is not to be used for any non-residential, commercial, or industrial application.
- Do not handle the power cord, plug, or appliance controls with wet hands.
- Wipe any moisture or dirt off the cord or plug with a dry cloth.
- Never attempt to operate this appliance if it is damaged, malfunctioning, partially disassembled, or has missing or broken parts, including a damaged cord or plug. Take it to an authorized LG Electronics service centre or dealer for assistance.

- Do not apply excessive force to the power cord to bend it, or place it under a heavy object as this will damage it.
- Do not use multiple-outlet adapters with this appliance. Make sure to use a power socket with a capacity of 10 A.
- Do not plug the appliance into a damaged or loose outlet.
- Make sure to unplug the power cord when the appliance is not to be used for an extended period of time.
- Do not damage, alter, excessively bend, twist, pull, pinch or heat the power cord.
- Before using the appliance, remove any wire or string on the floor.
- Avoid touching the prongs of the power plug with your finger(s) when unplugging the power cord.
- Do not cover the power cord with a rug or carpeting.
- Push the power plug firmly into the wall outlet so that it is not loose.
- If the product has been submerged, contact an LG Electronics service centre or dealer for instructions before resuming use.
- If the product makes a strange noise or emits an odour or smoke, discontinue use and contact an LG Electronics customer information centre.
- Only qualified technicians or service personnel from LG Electronics may disassemble, repair or modify the appliance.
- Never insert a sharp metallic object such as a pin, nail or knife in a hole or gap in the appliance or the charging station.
- Do not vacuum liquids with this appliance. Make sure that no water, beverage or detergent gets inside the appliance or the charging station.
- Do not allow the appliance to sweep up blades, thumb tacks, sawdust, sharp objects, or hot or cold ashes.
- Do not allow children to use the appliance.
- Do not let children or pets get close to the appliance when using, charging or storing.
- Do not insert the nozzle or tools in your mouth.

- Keep clothing and hair, fingers, or other parts of the body away from openings and moving parts.
- Do not operate the appliance with the suction inlet or outlet blocked.
- Do not use the appliance without the dust bin and filters in place.
- Do not use in an enclosed space where vapors are present from paint thinner, mothproofing substances, flammable dust or other explosive or toxic materials.
- Do not touch the charging terminals on the appliance or the charging station, or insert an electrified object inside the appliance or the station.
- Always store the appliance on the charging station when it is not in use.
- Do not lean the appliance on walls, chairs or tables.
- If the earth leakage breaker is tripped when the product is put on the charging station, immediately remove the appliance from the charging station. Contact an LG Electronics customer service centre.
- Use extra care when cleaning on stairs.
- Do not use or store a heating device or flammable substance(ether, benzene, alcohol, chemicals, combustible sprays, insecticide, air freshener or cosmetics) in close proximity to the appliance.
- Do not attempt to clean up a liquid substance (water, beverage), odourous substances (candy, chocolate, pet excrement), metallic objects (blades, pins), flammable substances, burning/ smoking(cigarettes, matches, or hot ashes), surfactants, or glass shards with this appliance.
- In the event of a gas leak(natural gas, propane gas, etc.), do not operate this or any other appliance. Open a window or door to ventilate the area immediately.
- Do not hold the charging station upside down with the battery in the charging station.
- Do not expose the appliance, and the battery in particular, to heat, a heating device or direct sunlight.
- Do not keep the appliance or its battery inside a vehicle which is exposed to direct sunlight.

- Never allow any water, beverage or detergent to get inside the battery.
- Do not apply physical impacts to the battery.

Maintenance

- Make sure to unplug the power cord when cleaning or maintaining the charging station.
- Do not wash the inlet port or the dust bin with water or detergent.
- Do not use detergents, polishes or air fresheners to clean the dust bin.
- Do not apply or spray a flammable substance (gasoline or thinner) or surfactants (detergent or bath soap) on the appliance.
- Wash hands after handling nozzles. The nozzles contain carbon fiber, and contact may cause minor skin irritation.

Disposal

- Keep packing materials out of the reach of children. Packaging materials can pose a suffocation risk for children.
- Destroy the carton, plastic bag, and other packing materials after the appliance is unpacked. Children might use them for play. Cartons covered with rugs, bedspreads, or plastic sheets can become airtight chambers.
- Dispose of this appliance according to local, state, and regional laws and regulations.
- Contact your local city council or the related government authority before disposing of this appliance.

Mop Nozzle

- Do not use the mop nozzle to clean up sharp objects such as glass shards, wires, blades, or pins. The sharp objects could become embedded in the mop pads and cause injury when you clean the pads.

- When using the mop nozzle, do not spray detergent towards people or animals.
- When spraying the detergent, be careful not to get it in your eyes or mouth.

CAUTION

CAUTION

- To reduce the risk of injury to persons, malfunction, or damage to the product or property when using the appliance, follow basic safety precautions, including the following:
-

Operation

- This appliance has a built-in safety device to prevent damage from overheating. If the appliance becomes overheated after extended use, it may automatically turn off. If this occurs, leave the appliance in a cool, well-ventilated area for about an hour before turning on the power again.
- Do not subject the product to shocks or drop it.
- Do not install wet or damp filters.
- Always use a soft cloth to clean the appliance. Do not clean the product with a volatile or organic solvent (thinner or acetone).
- Do not clean the same spot repeatedly for an extended period of time. Doing so may damage the carpet or flooring surface.
- Keep fingers away from pinch points when assembling the appliance or the charging station.
- Do not apply force or any impact to the Cyclonic Mesh Filter.
- Do not remove the battery during operation.

Mop Nozzle

- Do not use the mop nozzle for purposes other than domestic floor cleaning. The product is not designed for purposes such as polishing a car or cleaning windows.

- When using the mop nozzle, always attach the mop pads.
- Do not clean coated, rough or delicate floating floors or any kind of carpet with the mop nozzle.
- Do not use the mop nozzle to clean the same spot repeatedly for an extended period of time.
- Do not step on the mop nozzle.
- Wet floors can pose a slip hazard. Allow floors to dry completely before allowing anyone to walk on them.
- Do not store the appliance with a full water tank attached to the mop nozzle.
- Use only diluted detergents suitable for cleaning the floor.

INSTALLATION

Product Overview

The images in this guide may be different from the actual components and accessories, which are subject to change by the manufacturer without prior notice for product improvement purposes.

Front View

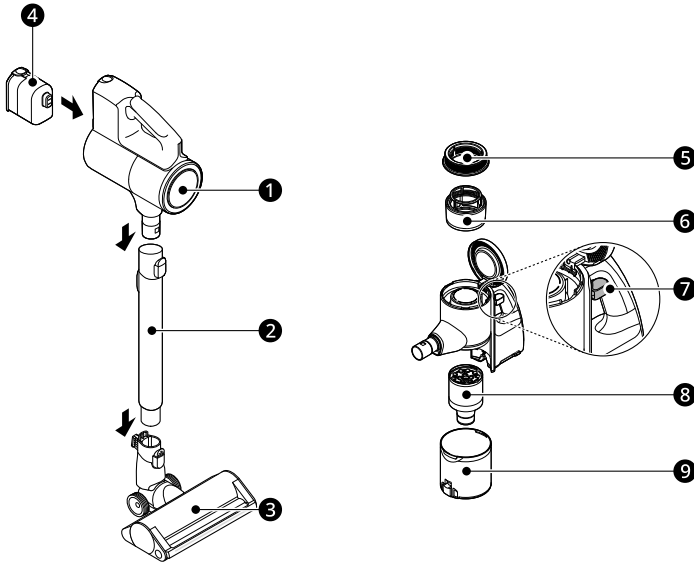

- ① Product Body
- ② Extension Pipe
- ③ Nozzle
- ④ Battery (Dual Battery)
- ⑤ Exhaust Filter
- ⑥ Pre-filter
- ⑦ Kompressor Lever
- ⑧ Cyclonic Mesh Filter
- ⑨ Dust Bin

NOTE

- Use the vacuum cleaner only with the provided charging station. Using a charging station other than the one designed to be used with the vacuum cleaner, as improper sealing of the charging station may result and dust not being emptied from vacuum cleaner.
-

Accessories

Included Accessories

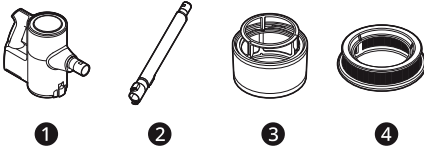

5

- 1 Product Body
- 2 Extension Pipe
- 3 Pre-filter
- 4 Exhaust filter
- 5 Battery (Dual Battery)

Basic Accessories

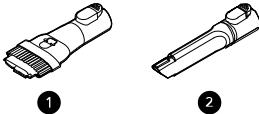

- 1 Combination Tool
- 2 Crevice Tool

Nozzles

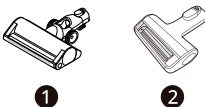

- 1 Dual Floor Max Nozzle
- 2 Pet Nozzle

Mop Kit

This accessory is only included with A9X-ULTRA2 / A9X-ULTRA2G

model.

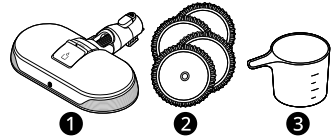

- 1 Power Drive Spray Mop
- 2 Mop Pads for Mop Nozzle
- 3 Measuring Cup

NOTE

- The mop pads, batteries, exhaust filter and the pre-filter will eventually need to be replaced. Contact an LG Electronics customer service centre.

Optional Accessories

This accessory not included in any A9X models. Each sold separately.

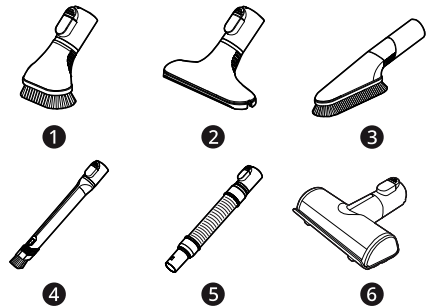

- 1 Hard Dirt Tool
- 2 Mattress Tool
- 3 Multi-angle Tool
- 4 Flexible Crevice Tool
- 5 Flexible Hose Extension
- 6 Bedding Nozzle

Specifications

Appliance

Model	A9X-ULTRA2 / A9X-AUTO2 / A9X-ULTRA2G
Dimensions (Width X Depth X Height)	265 mm X 305 mm x 1100 mm
Weight	Approximately 2.9 kg
Battery Run Time	Runs up to 120 minutes*1

- Dimensions are given for the assembled product body, extension pipe and nozzle.
- Battery run time is the result of using a fully charged battery according to the LG Electronics test standard. Results may be different depending on actual use environment and period of use.
- Recommended maximum run time when using the mop nozzle is 80 minutes. Otherwise, the motor may overheat.

*1 Up to 120 minutes run time when using 2 batteries in low power mode without any nozzle. Actual run time may vary when using nozzle attachments and depending on the operating environment and settings.

Charging Station

The provided charging station is different by the purchased models.

Model	VDS-ST4TN / VDS-ST4WN / VDS-ST4GN
Input	220-240 V~ 50 Hz
Output	28.3 V ⁼⁼⁼ / 1.15 A
Power Consumption	1700 W (Cleaning) 0.4 A (Charging)

Storing the Accessories

Assembling and Storing the Appliance

Follow these steps to safely assemble the appliance.

- 1 Firmly attach the extension pipe ③, nozzle ④, or tool onto the product body ①.

- To detach the extension pipe, press the extension pipe release button ②.

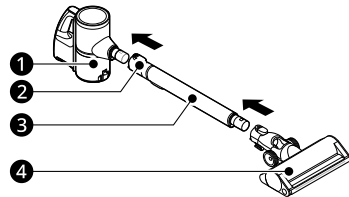

- 2 Put the product body on the charging station.

16 INSTALLATION

- If the vacuum cleaner fits properly inside the charging station, the alarm will sound. Wait several seconds and if the alarm does not sound, reinsert the vacuum cleaner, making sure that the nozzle is horizontal.

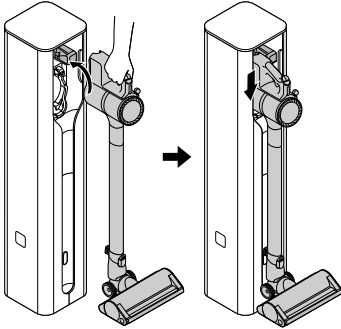

- 2 Hang the nozzle on the nozzle hook.

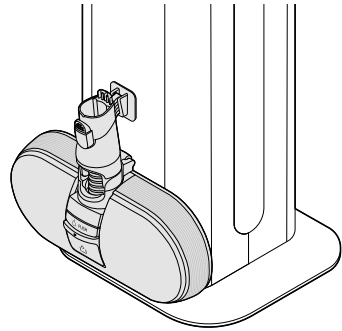

Storage Inside

- 1 Open the left door of the product and insert the bedding nozzle or the pet nozzle ❶ for storage.

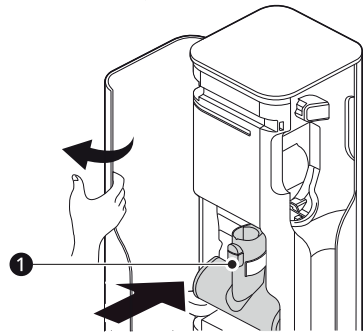

Storing the Tools

Use the product to store the inlet and components provided with the vacuum cleaner.

The components may differ depending on the vacuum cleaner model.

Storing on Sides

- 1 Open the nozzle hook ❶ on both sides of the product.
- To open the nozzle hooks, press on the right side. Be careful not to pinch fingers when opening.

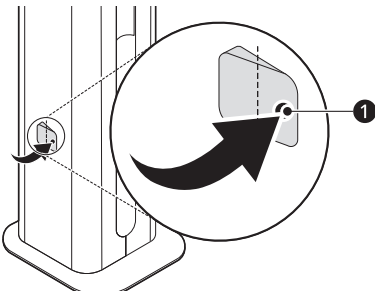

- 2 Open the right door and insert the combination tool ② and the crevice tool ③ for storage.

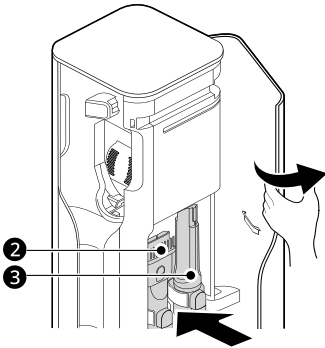

Moving the Product

To carry the product, open both doors and hold the areas shown.

- Before moving the product, unplug it and remove the vacuum cleaner, nozzles, and accessories.

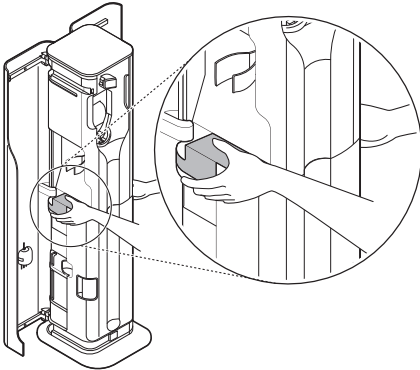

OPERATION

Getting Started

Before Using the Appliance

- Support the bottom of the appliance when cleaning an elevated surface.
- To avoid scratches on polished floors, keep tools and the brushes and rollers of the nozzles free from hair, grit, sand, or abrasive objects.
- Make sure that the exhaust filter, pre-filter and the dust bin are properly assembled before using the appliance.
- Close the dust bin cover properly before using the appliance. If the dust bin cover is left open, the suction strength may deteriorate and affect the cleaning results.
- Store the appliance in the charging station or place it flat on the floor when not in use. Leaning the appliance against a wall or chair can result in product damage or personal injury if the appliance falls.
- Environmental conditions such as temperature and humidity may cause static electricity to accumulate on the appliance. Please contact LG Electronics customer information centre if the problem persists.
- Make sure to remove any foreign object such as a sock or stocking before using the appliance. Any foreign object on the inlet port or extension pipe will prevent the appliance from functioning properly.
- Please use the product at normal room temperatures as the battery runtime may deteriorate severely if used at temperatures lower than 5 °C or higher than 38 °C for an extended period of time.
- The battery runtime is dependent on the surface type and the suction power.
- Follow manufacturer's recommendations when cleaning flooring, carpets, and rugs.
- Refer to the **Specifications** section for battery runtime details.

Assembling Attachments

Nozzles and tools can be attached to either the product body or the end of the extension pipe.

- 1 Insert the fully charged battery ① into the cavity at the bottom of the handle on the product body and push the battery until it clicks.
 - If it is not properly inserted, the battery may fall out, causing product to malfunction or personal injury.

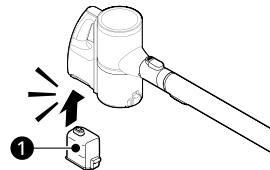

- 2 Attach the nozzles, tools, or extension pipe by sliding them onto the inlet ② on the body until they click into place. The nozzles and tools can also be attached to the end of the extension pipe ②.
 - Detach the accessories by pressing the release button ③.

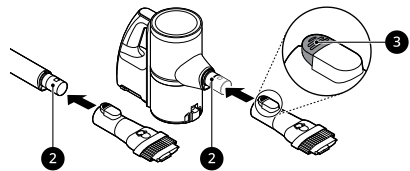

- 3 Adjust the extension pipe by pressing the length adjustment button ④ on the back of the pipe and sliding until it clicks into place at the desired length.

- The extension pipe extends in four steps.

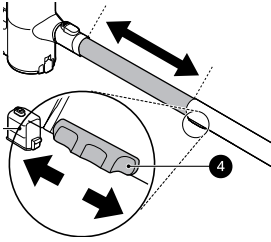

4 Press the **Power** button to activate the **Normal** mode.

- To turn off the appliance, press the **Power** button again.

Control Panel Features

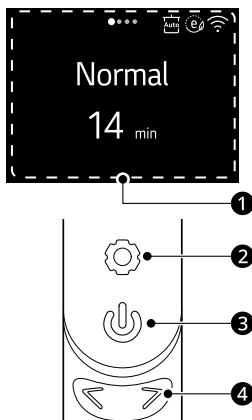

Control Panel



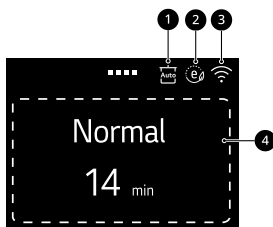

	List	Descriptions
①	Status Display	For details, see below Status Display .
②	Setting button	Press the Setting button to change the settings of the product.
③	Power button	Press the Power button to turn the appliance on or off. <ul style="list-style-type: none"> When the power is turned on, the product operates in the suction power mode set by the Default suction power setting.
④	Move button	Press the Move button to adjust the suction power. <ul style="list-style-type: none"> Press the Move button after pressing the Setting button to select the setting to change. When using the spray mop nozzle, press the > button to spray diluted detergent on the floors. Using unsuitable detergents can damage the floors finish. Never use or add solvents or undiluted detergents to the water tank.

Status Display



	List	Descriptions
①	Auto dust emptying mode Indicator	<ul style="list-style-type: none"> • Displayed the automatic dust emptying mode is on. <ul style="list-style-type: none"> - Automatic dust emptying mode automatically starts the operation every time the vacuum cleaner is mounted correctly onto the station. - If you accidentally remove the vacuum cleaner and mount it immediately, the dust emptying operation may not start automatically, depending on the circumstance. If it doesn't start automatically, select the START/STOP button to start. - When the vacuum cleaner is not mounted onto the station, the automatic dust emptying indicator is not updated.
②	Battery Life Extension Mode Indicator	<ul style="list-style-type: none"> • This indicator lights up when the Battery Life Extension Mode is On.
③	Wi-Fi Indicator	<ul style="list-style-type: none"> • This indicator lights up when the product is connected to a home Wi-Fi network. <ul style="list-style-type: none"> -  (Paired) : The Wi-Fi setting in the Setting Mode is On and the product is connected with the LG ThinQ application. -  (Unpaired) : The product lost network connection when connected status. - None (Not Paired) : The Wi-Fi setting in the Setting Mode is Off or the product is not connected with the LG ThinQ application even though the Wi-Fi setting is On.
④	Battery Run Time and Notification Display	<ul style="list-style-type: none"> • The current cleaning mode, remaining battery run time and the notifications are shown in the display. The battery run time is a guide only and will fluctuate depending on the nozzle attached, floor surface type and the age of the battery.

Settings

- 1 Press the **Setting**  button.
- 2 Select the desired settings using **Move** <> button and adjust them as needed.
 - Select **Exit** by pressing the **Setting**  button to revert to the previous screen.

NOTE

- If no action is taken for 10 seconds after pressing the **Setting**  button, the display reverts to the previous screen.

Default Suction Power

Select the suction power mode that operates when the product is turned on.

Screen Brightness During Charging

Adjust the brightness of the status display that displays the charge level when charging the product.

Charging Notification Sound

Adjust the volume of the notification sound when the product is mounted on the charging station.

Battery Life Extension Mode

The  icon displays on the status display when the **Battery Life Extension Mode** is set. The mode can slow down the battery aging by limiting the battery charging level by 85 %. However, this mode only affects the battery which attached on the vacuum cleaner. The auxiliary battery are charged 100%.

Wi-Fi

Wi-Fi function can be turned on or off.

Wi-Fi Settings

Use this settings to check whether the product is connected to the network or to reconnect to the network.

• Not Paired

- The Wi-Fi setting in the **Setting Mode** is **Off**.
- The product is not connected with the **LG ThinQ** application even though the Wi-Fi setting is **On**.
- Start the Wi-Fi connection by pressing the **Setting**  button.

• Paired

- The Wi-Fi setting in the **Setting Mode** is **On** and the product is connected with the **LG ThinQ** application.
- Reconnect the Wi-Fi by pressing the **Setting**  button.

• Unpaired

- The product lost network connection when connected status.
- Check the Wi-Fi network. If the product cannot connect to the network, change the network using **LG ThinQ** application or reset Wi-Fi by pressing the **Setting**  button.

Reset Wi-Fi

Reset all Wi-Fi related settings of the product and disconnect the product from the network.

Auto Stop&Go

When you put the vacuum cleaner down to tidy up during cleaning, the vacuum cleaner automatically goes into standby mode to save energy. When you start cleaning again, it automatically starts suctioning without having to press the **power** button.

The standby mode remains for 5 minutes, after which the power turns off.

- This function is activated when the vacuum cleaner is completely placed on the floor. The function does not work when placed against a wall or chair.
- If the vacuum cleaner is used without a nozzle attached, this function will be deactivated if the vacuum cleaner moves.
- If the vacuum cleaner is used with a nozzle attached, this function will be deactivated if you hold the vacuum cleaner handle and lift it for more than 30 degrees.
- If you press the <, > button on the vacuum cleaner, this function will be immediately deactivated.

Charging the Battery

Before Charging the Battery

- Make sure that the adapter is connected to both the charging station and the power outlet.

- Fully charging a single battery usually takes 4 hours. It will take twice as long to charge both the main and spare batteries.
- The battery will not be charged if the indoor temperature is below 5 °C. Only charge the battery when indoor temperatures are between 5 °C and 38 °C.
- The battery will eventually need to be replaced. Due to the battery characteristics, runtime is shortened after using the appliance repeatedly for an extended period.
- The last bar on the battery indicator begins to flash when the battery needs to be recharged. Use the appliance with a fully charged battery.
- To maintain battery life on dual-battery models, swap the positions of the two batteries periodically, between the main body and the spare charging station.

- When the charging is complete, the status display turns off.

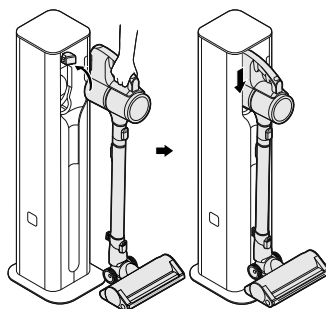

⚠ WARNING

- Make sure to securely fit the product body onto the charging station. If the appliance falls off the charging station, it could cause injuries, property damage or product damage.

Charging the Vacuum Cleaner

Storing the appliance on the charging station automatically recharges the battery.

- 1 Press the **Power** button to turn the appliance off.
- 2 Put the product body on the charging station.
 - Make the extension pipe its shortest length before placing the vacuum onto the charger.
 - The appliance cannot be loaded onto the charging station if either the combination tool or the crevice tool is inserted. Use the charging station only after removing the combination tool or the crevice tool, if either happens to be fitted
 - When the vacuum is properly placed on the charging station, the battery charge level is displayed on the status display with the beep sound. If you don't hear a beep, reload the appliance on the charging station.

Charging the Spare Battery

After the vacuum cleaner has finished charging, the spare battery will start charging.

One or two batteries are provided. The number of batteries varies depending on the model purchased.

- 1 Lift the front of the control panel located at the top of the charging station.

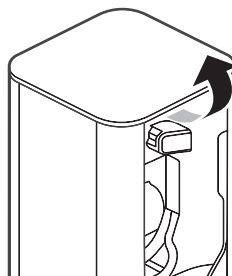

- 2 To insert, align the battery with the outline of the battery charger.

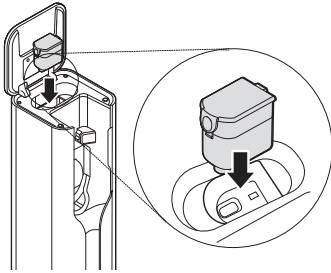

- 3 Press the battery down into the compartment.

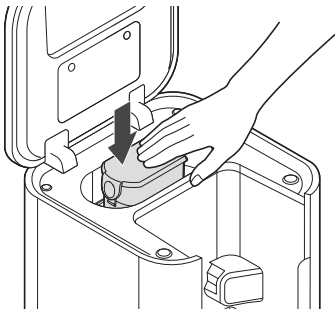

NOTE

- If the spare battery is inserted correctly, the spare battery icon will be displayed. The spare battery charging begins after the vacuum cleaner battery charging is complete.
- Insert the spare battery completely. If the spare battery is inserted correctly, the spare battery icon will be displayed.

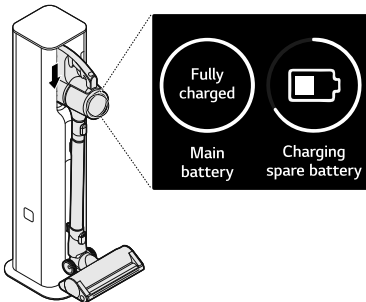

Using the Mop Nozzle

Before Using the Mop Nozzle

- The mop pads only rotate at one speed regardless of what suction power setting the product body is set to.
- To prevent product damage, the mop attachment plate will automatically stop if there are foreign objects stuck in the plate or if it is subjected to a strong impact. Turn the appliance off immediately and remove the foreign objects or obstructions before resuming use.
- If you hear a noise while mopping, the mop pad may have dropped off the mop attachment plate. Turn off the product immediately and reattach the mop to the attachment plate before resuming use.
- Do not use a soiled mop pad to clean floors. Using soiled mop pads or pads containing debris can damage flooring. Always check the pads after each use.
- Use only authorized LG Electronics mop pads.

Using the Mop Nozzle

This accessory is only available on some models. When the mop nozzle is attached, the suction is turned off and only the mop function operates. Press the **Power**  button to turn the mop on/off.

CAUTION

- Do not assemble or disassemble the nozzle while the appliance is turned on. Doing so may result in injury.
- Do not let the appliance stand on the floor while the wet mop pads are attached. Doing so may result in damage or swelling of wood flooring. Always check with the flooring manufacturer or supplier for wet mopping suitability.
- Do not use on PVC or polyurethane mats for infants or children. Friction can cause the motor to overheat.

NOTE

- If you use the mop nozzle for a long time, the motor may overheat. (Recommended maximum run time is 80 minutes.) If the motor overheats, a safety function is activated and the appliance automatically turns off. Set the appliance in a cool, well-ventilated place and allow it to cool down for about an hour before resuming use.

Filling the Water Tank

Before mopping, you must fill the water tank and attach it to the mop nozzle.

- 1 Press the **PUSH** button ① to remove the water tank from the mop nozzle.

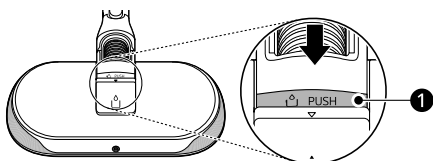

- 2 Open the water inlet cap ② and fill the tank with water using the measuring cup ③.

- If adding detergent, make sure it is fully diluted in the water and is suitable for cleaning the floor. Using unsuitable detergents can damage the floors finish. Never use or add solvents or undiluted detergents to the water tank.

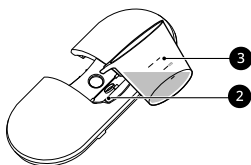

- 3 Close the water inlet cap tightly.

- If the water inlet cap is not closed properly, water or the added liquid solution may leak.

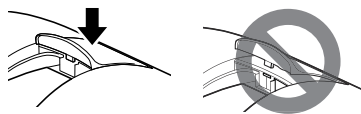

- 4 Attach the water tank to the mop nozzle again.

- Insert the 2 tabs ⑤ at the front of the water tank into the slots ⑥ on the top of the mop nozzle. Lower the back of the water tank into place.
- Press down at the center ⑦ to lock the tank in place.

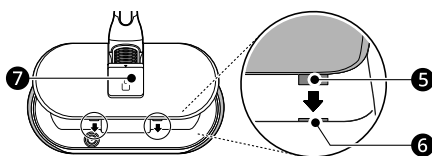
**Attaching the Mop Pads**

Use the standard mop pads for general cleaning.

⚠ WARNING

- To avoid injury, do not attach the mop pads while the mop plates are moving.
- Do not insert your hand between the rotating mop plates. Doing so may result in injury. Never use the Mop nozzle without fitting the damp mop pads as this will damage the flooring.

- 1 Wet both sides of the mop pads with water and squeeze out any excess water before attaching the pads to the mop nozzle body. The Mop pads will only attach securely when the correct side is attached to the nozzle.

- Do not attach pads while they are dripping wet.

- Attaching and using mop pads while they are dry may affect the cleaning performance.

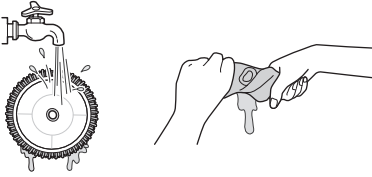

2 Place the mop nozzle upside down on the floor.

3 Align and attach the centre of the mop pad with the centre of the mop plates.

- Press firmly to attach the Velcro on the mop pad to the mop plate. Attaching the mop pad upside down or improperly may affect the cleaning performance.

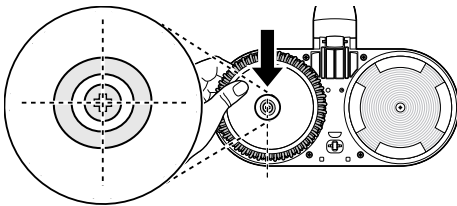

4 Attach the mop nozzle to the appliance.

Using the Mop Nozzle

1 Attach the water tank and mop pads to the mop nozzle.

2 Press the **Power**  button to start cleaning.

3 Press the **Move**  button to spray diluted detergent.

Drying the Water Tank and Mop Pads

Drying the Water Tank

When cleaning is completed, make sure to empty the water tank and dry it before storing the mop nozzle.

CAUTION

- Turn the water inlet cap to make sure it remains open when storing the water tank. If the cap is closed and the tank is not completely dry, the trapped moisture can cause odors. Any remaining diluted detergent in the tank when stored can harden and cause the water tank and mop nozzle to malfunction.
- After cleaning, wipe off any remaining water from the water supply inlet **1** on the mop nozzle with a soft cloth. The water could drip onto the floor and damage it.

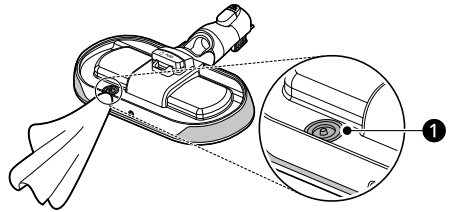

- Do not pull or stretch the rubber gasket on the water supply inlet. Doing so may tear or damage it.

1 Open the water inlet cap **2** and fill the tank with water using the measuring cup **3**.

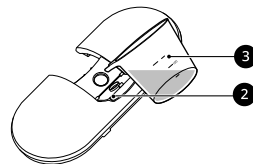

- 2 Close the water inlet cap and shake the water tank to wash inside.

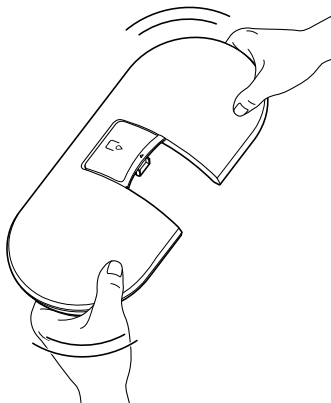

- 3 Open the water inlet cap ① on the middle of the water tank and empty the water tank. Shake the water tank to remove any remaining water.

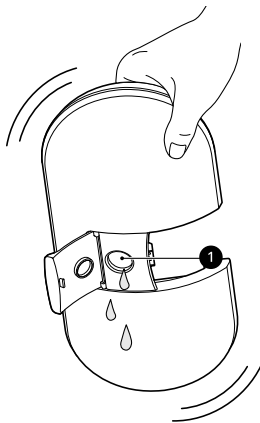

- 4 Leave the water inlet cap open and allow the water tank to dry in a well-ventilated area out of direct sunlight for at least 24 hours.

- Only store the water tank once it is completely empty and dry. Moisture or residual water in the tank may cause odor.

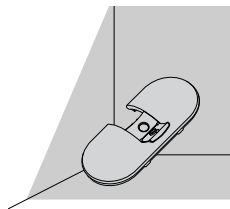

Drying the Mop Pads

After using the mop pads, hand wash them and allow them to dry before storing them.

⚠ CAUTION

- Follow these precautions to prevent mop pads from becoming deformed.
 - Do not use bleach or fabric softener when washing the mop pads.
 - Do not dry the pads in a clothes dryer.
 - Do not boil the mop pads.
 - Mop pads are a consumable item and should be replaced when they wear or no longer clean.

- 1 Separate the mop pads from the mop plates.
- 2 Hand wash the pads with a neutral detergent.
- 3 Set the pads in a well-ventilated area out of direct sunlight for at least 24 hours or until completely dry.
 - Storing the mop pads before they are completely dry may cause odors.

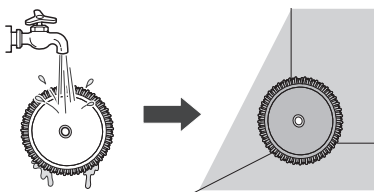

Using the Nozzles and Tools

Before Using the Nozzles and Tools

Some accessories are only available on some models.

Specialized attachments can help you clean more effectively. Tools and nozzles can be attached to the product body or the extension pipe.

- Adjust the suction power if the inlet gets stuck on the floor, carpet, or bedding.
- Each Nozzle is equipped with a motor and may make a sound when operating.

⚠ CAUTION

- Do not use the Multi-Surface Nozzle or Slim Hard Floor Nozzle on PVC or polyurethane mats for infants and children. The mat may stick to the nozzle, making it difficult to operate, causing damage to the mat or static electricity on the appliance. Clean mats using the crevice tool.

Dual Floor Max Nozzle

Use this nozzle to clean carpets, rugs or hard floor surfaces.

Pet Nozzle

It is suitable for soft surfaces and pet hair removal.

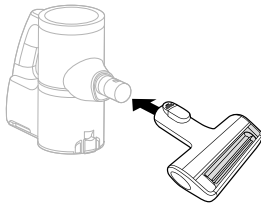

⚠ CAUTION

- Do not use the nozzle following surface. It may cause scratch or damage. Especially, do not

clean a coated or lacquered floor. If used repeatedly, the coating may wear off.

- Clothing, bedding
- Leather cushioned sofas, cushions
- Carpet
- Vinyl flooring, tiles, marble, etc.

Bedding Nozzle

This nozzle lets you clean sheets and bedding more effectively. It removes dust in bedding using strong suction and a punching motion.

- Lower the suction level when vacuuming bedding such as duvet covers to avoid the thin fabric getting sucked into the nozzle.

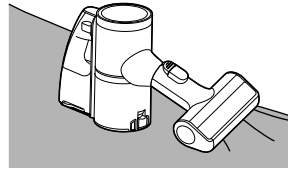

Crevice Tool

Use this tool to remove dust from corners or narrow spaces.

- Use it for areas with static electricity such as mats.
- Use it with the **Turbo** mode to clean pet hair out of furniture, mats, or tight areas like corners.

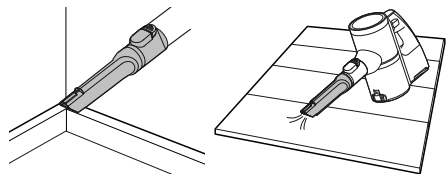

Combination Tool

Can be used in either crevice mode or brush mode for cleaning corners or small gaps where dust and dirt gather.

• Crevice Mode

Use the tool in the crevice mode to clean flat surfaces such as sofas or mattresses.

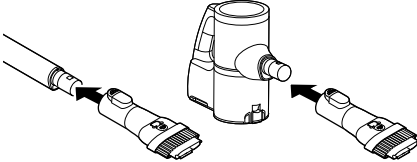

• Brush Mode

Use the tool in the brush mode to clean delicate surfaces such as frames or furniture.

- To convert modes, press the adjustment button ❶ and push forward.

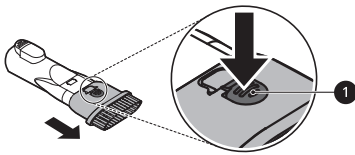

Hard Dirt Tool

Firm bristles remove solidified dirt from hard surfaces. Clean up hair or foreign objects that are entangled in carpets or rugs.

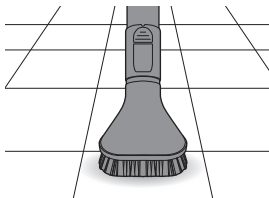

Mattress Tool

Use this tool to clean up dust and foreign objects from mattresses, delicate fabrics, and upholstery.

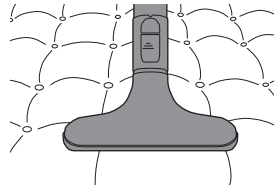

Flexible Crevice Tool

This tool is flexible and its length can be adjusted, making it especially useful for cleaning inside vehicles or in narrow spaces under and behind furniture where an angled tool is needed.

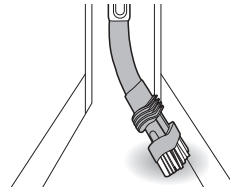

Using the Brush

To convert the tool from crevice to brush mode, press in on the sides of the brush head ❶ and pull the brush down.

- To convert back to the crevice mode, press in on the brush release button ❷ and slide the brush up.

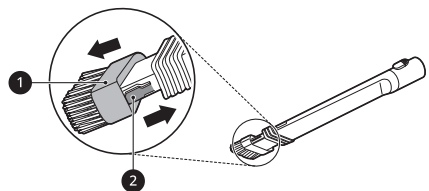

Adjusting the Length

To adjust the length of the tool, press and hold the release button ❸ on the side of the tool. Pull or

30 OPERATION

push on the brush head **4** to extend or retract the extension tube.

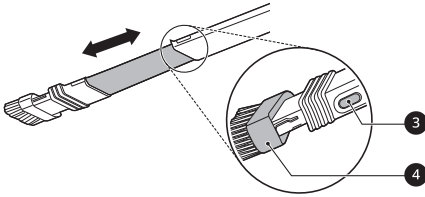

- Compressing the dust clears it off the interior walls of the dust bin and allows you to vacuum for longer periods before emptying the dust bin. It also makes cleaning the dust bin easier and less messy.
- The dust bin must be at least half full for the compression plate to be effective.
- Press the Kompressor lever down several times to compress the dust and clean off the interior walls of the dust bin.

Multi-angle Tool

This tool has a soft brush that can be adjusted to a variety of angles, making it especially useful for cleaning vehicle consoles or the tops of furniture.

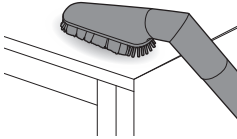

Flexible Hose Extension

Connect this flexible, extendable hose between the product body and the tools to clean hard to reach areas.

- The flexible hose extension cannot be used with the Nozzle.

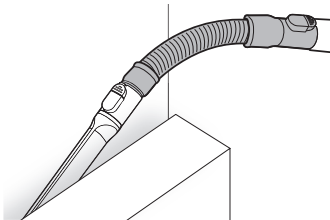

Using the Kompressor Lever

Use the Kompressor to compress hair and fibers inside the dust bin after vacuuming and before emptying the dust bin.

- The vacuum must be turned off before using the Kompressor lever.

SMART FUNCTIONS

Using LG ThinQ Application

The **LG ThinQ** application allows you to communicate with the appliance using a smartphone.

LG ThinQ Application Features

- **Setting the default mop operation**
 - This function allows the setting of the default operation mode of the Mop Nozzle.
- **Cleaning History**
 - Shows the cleaning history, such as monthly cleaning time, cleaning frequency, and cleaning mode, etc.

NOTE

- Assembled suction tool is displayed on the screen during cleaning.
- A notification is displayed on the screen if the pre-filter and the exhaust filter need cleaning.
- **Filter Cleaning Cycle Alarm**
 - After using the appliance for a certain period of time, a notification is displayed on the screen of your smartphone. Clean the exhaust filter or pre-filter, if necessary.
- **Cleaning Mode**
 - The cleaning mode you are using is displayed on the screen of your smartphone.
- **Filter Cleaning Guide**
 - Guide to cleaning the filters.
- **Smart Diagnosis™**
 - This function provides useful information for diagnosing and solving issues with the appliance based on the pattern of use.

NOTE

- In the following cases, you must update the network information for each appliance in the **LG ThinQ** application under **Device Cards** → **Settings** → **Change Network**.
 - wireless router is changed

- wireless router password is changed
- Internet service provider is changed
- This information is current at the time of publication. The application is subject to change for product improvement purposes without notice to users.

Installing LG ThinQ App and Connecting an LG Appliance

Models with QR Code

Scan the QR code attached to the product using the camera or a QR code reader app on your smartphone.

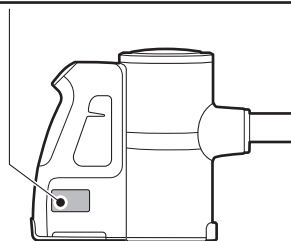

Models without QR Code

- 1 Search for and install the **LG ThinQ** app from the Google Play Store or Apple App Store on a smartphone.
- 2 Run the **LG ThinQ** app and sign in with your existing account or create an LG account to sign in.
- 3 Touch the add (+) button on the **LG ThinQ** app to connect your LG appliance. Follow the

instructions in the app to complete the process.

NOTE



- You may be asked to provide a password to connect to the LG network (not your home network) during the Wi-Fi setup. The password is the last 4 characters of the network name, repeated twice, with no spaces. For example, if the network name appears as LG_XXXX_8b92, then you would enter 8b928b92 as your password. The password is case sensitive and the last 4 characters are unique to your appliance.
- To verify the Wi-Fi connection, check that the  icon on the control panel is lit.
- The appliance supports 2.4 GHz Wi-Fi networks only. To check your network frequency, contact your Internet service provider or refer to your wireless router manual.
- **LG ThinQ** is not responsible for any network connection problems or any faults, malfunctions, or errors caused by network connection.
- If the appliance is having trouble connecting to the Wi-Fi network, it may be too far from the router. Purchase a Wi-Fi repeater (range extender) to improve the Wi-Fi signal strength.
- The Wi-Fi connection may not connect or may be interrupted because of the home network environment.
- The network connection may not work properly depending on the Internet service provider.
- The surrounding wireless environment can make the wireless network service run slowly.
- If the appliance cannot be connected due to problems with the wireless signal transmission, unplug the appliance and wait about a minute before trying again.
- If the firewall on your wireless router is enabled, disable the firewall or add an exception to it.
- The wireless network name (SSID) should be a combination of English letters and numbers. (Do not use special characters.)
- Smartphone user interface (UI) may vary depending on the mobile operating system (OS) and the manufacturer.

- If the security protocol of the router is set to **WEP**, network setup may fail. Change the security protocol (**WPA2** is recommended) and connect the product again.
-

Turning Wi-Fi On/Off on the Appliance



Wi-Fi can be turned on or off in the status display.

Disconnecting from Wi-Fi

- 1 Press **Power** button to turn on the product.
- 2 Press the **Setting**  button to enter the setting mode.
- 3 Press the **Move** <> buttons to enter the **Wi-Fi Settings**.
- 4 Press the **Setting**  button to turn the Wi-Fi off.

Reconnecting to Wi-Fi

Follow the steps below on the appliance.

- 1 Press **Power** button to turn on the product.
- 2 Press the **Setting**  button to enter the setting mode.
- 3 Press the **Move** <> buttons to enter the **Wi-Fi Settings**.
- 4 Press the **Setting**  button to turn the Wi-Fi on.

RF Radiation Exposure Statement

RF Radiation Exposure Statement This equipment complies with radiation exposure limit (<4.0 W/kg for extremity (hand) exposure condition) set forth for an uncontrolled environment.

Open Source Software Notice Information

To obtain the source code that is contained in this product, under GPL, LGPL, MPL, and other open source licenses that have the obligation to disclose source code, and to access all referred license terms, copyright notices and other relevant documents, please visit <https://opensource.lge.com>.

LG Electronics will also provide open source code to you on CD-ROM for a charge covering the cost of performing such distribution (such as the cost of media, shipping, and handling) upon email request to opensource@lge.com.

This offer is valid to anyone in receipt of this information for a period of three years after our last shipment of this product.

Smart Diagnosis Function

Use this feature to help you diagnose and solve problems with your appliance.

NOTE

- For reasons not attributable to LGE's negligence, the service may not operate due to external factors such as, but not limited to, Wi-Fi unavailability, Wi-Fi disconnection, local app store policy, or app unavailability.
- The feature may be subject to change without prior notice and may have a different form depending on where you are located.

Using LG ThinQ to Diagnose Issues

If you experience a problem with your Wi-Fi equipped appliance, it can transmit

troubleshooting data to a smartphone using the **LG ThinQ** application.

- Launch the **LG ThinQ** application and select the **Smart Diagnosis** feature in the menu. Follow the instructions provided in the **LG ThinQ** application.

MAINTENANCE

Cleaning the Appliance

Before Cleaning the Appliance

To maintain the optimum suction power, the cyclonic mesh filter, the exhaust filter and the pre-filter should be cleaned regularly and washed under running water at least once a month.

- Turn off the power before cleaning the appliance.
- The frequency of cleaning varies depending on the usage environment and usage time. In a dusty environment, clean frequently.

⚠ WARNING

- Never wash the Nozzle, rotating brush or product body with water. Water could reach the motor and cause electric shock or fire.
- Do not use the cleaner without any of the filter fitted as this will allow foreign objects to enter the motor. Doing so may cause electric shock, fire or product damage.
- Do not insert fingers or sharp objects into the motor. Doing so could cause product damage, personal injury or electric shock.

⚠ CAUTION

- Do not apply force or allow impacts to the cyclonic mesh filter. Doing so could deform the filter, compromise product performance, or cause the product to malfunction.
- If the Kompressor lever does not return to the top, remove the cyclonic mesh filter from the dust bin and clean it. A clogged or dirty filter may cause poor cleaning results.

Removing Foreign Objects

If the appliance is clogged with foreign objects, the suction power changes and the motor cycles between low and high speed repeatedly.

If clogging persists, the appliance will turn off automatically to prevent damage. Separate the

battery from the product body and remove the foreign objects before resuming use of the appliance.

- Check the inside of the product body, above the Kompressor working plate, the extension pipe, inlets, exhaust filter, pre-filter and cyclonic mesh filter for foreign objects.
- If the inlets are not completely blocked, the foreign objects clogging alarm indicator may not light up but the suction ability will be affected.
- If the sound of the appliance becomes loud or the cleaning results is poor, check for foreign objects.

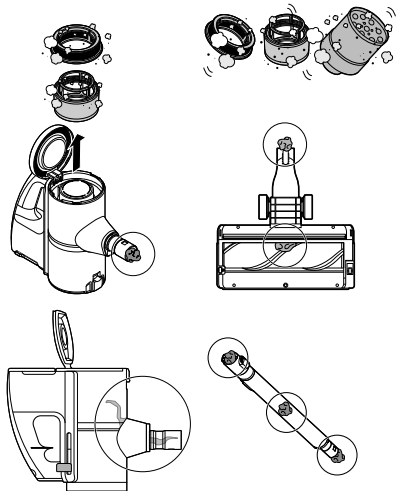

Cleaning the Dust Bin

Empty and clean the dust bin after every use.

- If the dust bin is completely full of dust or the filter is clogged, the suction power will be reduced.

- 1 Remove the battery from the product body before cleaning the dust bin.
- 2 Push down the Kompressor lever ① several times to collect and compact the dust from the

outside of the cyclonic mesh filter and the interior walls of the dust bin.

- Foreign objects which become lodged in the cyclonic mesh filter may be difficult to dislodge with the Kompressor lever. Remove the cyclonic mesh filter and use the cleaning brush, etc. to clean it.

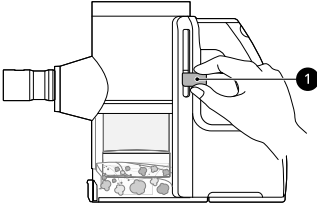

- 4 Insert the crevice tool (4) into the cyclonic mesh filter (3) and turn it counterclockwise to remove the filter.

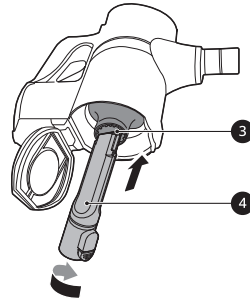

- 3 Press the dust bin cover release button (2) to open the dust bin cover. Shake the dust bin to empty it.

- Be careful as dust or foreign objects may spill out when opening the dust bin. Empty the dust bin into a wastebasket or where dust and foreign objects can be easily removed.
- The dust bin can be wrapped in a plastic bag to contain the dust when emptying the dust bin.

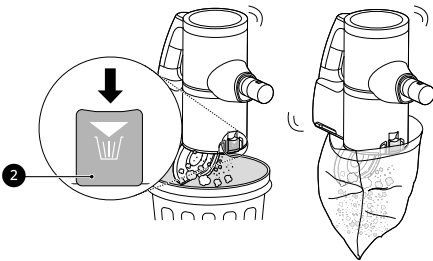

- 5 Grab the dust bin and turn it left to separate it from the product.

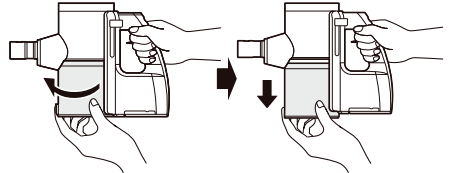

- 6 Wash the cyclonic mesh filter and the dust bin under running water.

- To avoid odour and the malfunction of the motor, allow the cyclonic mesh filter and the dust bin to dry completely in a well-ventilated area out of direct sunlight for at least 24 hours before reassembling.

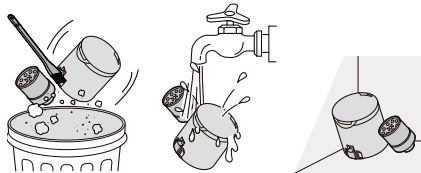

⚠ WARNING

- If the Kompressor lever does not slide down smoothly, foreign objects may be trapped between the dust bin and the cyclonic mesh filter. Clean the dust bin and cyclonic mesh filter to avoid product damage.
- Do not force the Kompressor lever down if foreign objects are caught around the working plate of the Kompressor system. Doing so may cause product damage.

- 7 Separate the dust bin from the product and turn the product over to clean the dust in the space between the Kompressor system using the cleaning brush, etc.

- Do not push the Kompressor lever down hard. The working plate may be damaged.

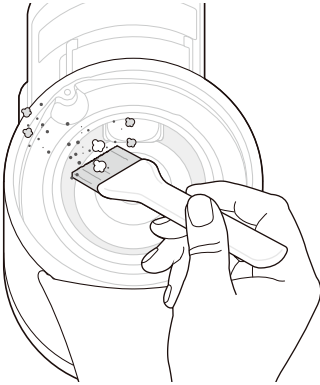

- 8 Turn the product over again and shake the remaining dust with the Kompressor lever pressed.
- 9 Turn the product body over again and shake it while pressing down the lever to remove the dust.
- 10 Turn the product body over and clean the inside the product with the cleaning towel.

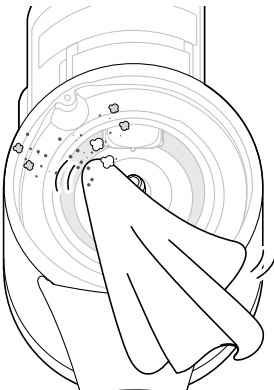

⚠ CAUTION

- Do not use the appliance without the cyclonic mesh filter and the dust bin installed. Doing so could damage the appliance.
- Turn the dust bin all the way to the left until it clicks into place when assembling the dustbin. If it doesn't click, it's not fully assembled.

Cleaning the Filters

Clean the filters more frequently if the appliance is used regularly or in areas with a lot of dust.

⚠ CAUTION

- Do not use the appliance without the exhaust filter and pre-filter installed. Doing so could result in product damage.

- 1 Remove the battery from the product body.
- 2 Hold the exhaust filter cover and turn it to left to open the cover.

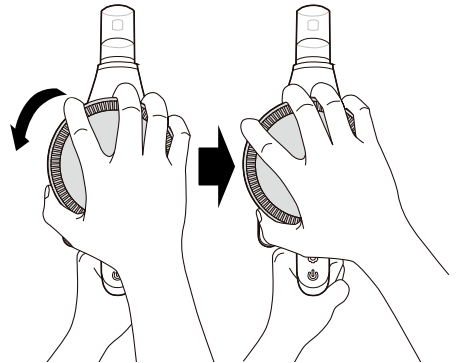

- 3 Lift the open cover up.

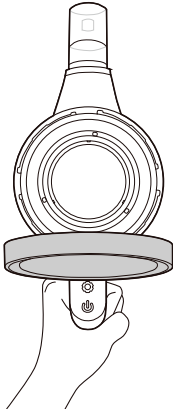

- 6 Clean filters by regularly brushing the dust off and wash them in running water at least once a month.

- To avoid odour and the malfunction of the motor, allow the exhaust filter to dry completely in a well-ventilated area out of direct sunlight for at least 24 hours before reassembling.



- 4 Lift out the exhaust filter ① and pre-filter ② from the product body.

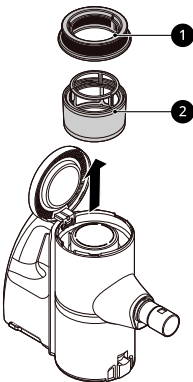

- 7 Reassemble the completely dried exhaust filter ① and pre-filter ② on the product body.

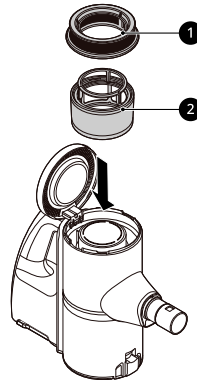

- 5 Use the combination tool ③ to clean any dust off the motor.

- Do not wash the motor with water.

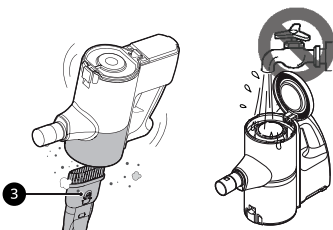

- 8 To lock the cover, turn the exhaust filter cover to right while holding down it.

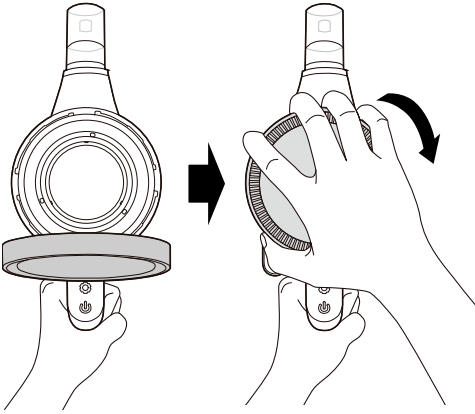

Cleaning the Nozzles

Clean the nozzle and rotating brush regularly.

⚠ CAUTION

- Always separate the nozzle from the product body or remove the battery before cleaning. If the nozzle starts to operate during cleaning, it could cause an injury.
- Keep fingers away from pinch points when assembling the nozzle on the appliance or the rotating brush on the nozzle.
- Do not use the rotating brush as a wet mop. It may cause product damage.
- Do not rinse or submerge the rotating brush or nozzle in water. It may cause product damage.

Cleaning the Dual Floor Max Nozzle

Clean the brush and roller heads before each use.

- If the brush contains foreign objects, the brush may not spin or a noise may occur during operation.

- 1 Press the nozzle release button ❶ to remove the nozzle from the extension pipe or product body.

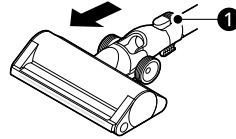

- 2 Turn the nozzle upside down. Press the button on the nozzle and turn the cover lock clockwise.

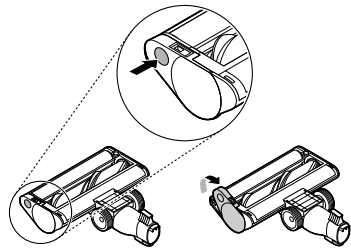

- 3 Pull the brush cover forward and pull the main brush out.

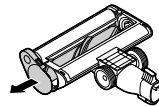

- 4 With the left button of the sub-brush pressed, pull the sub-brush out.

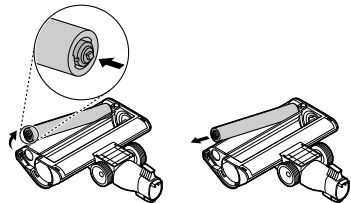

- 5 Attach the crevice tool to the product body and use the vacuum to remove foreign objects and

dust from the main brush, sub-brush and the bottom of the nozzle.

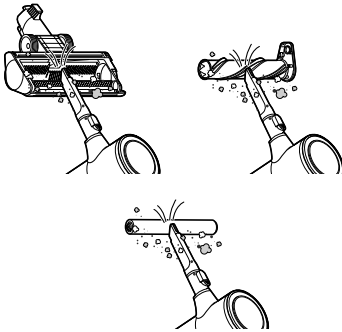

6 Use a damp towel or cloth to remove any remaining foreign objects and dust from both the brush and the bottom of the nozzle.

- Carefully use a tweezers to remove foreign objects from the nozzle rollers.
- Do not rinse or submerge the rotating brush or nozzle in water.
- Use a wet towel or cloth to clean both the rotating brush and nozzle.

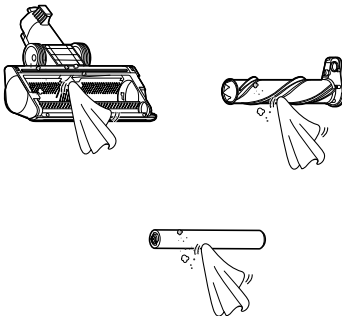

7 Slide the brushes back into the nozzle and rotate the cover back into place. Turn the cover lock clockwise to lock the cover.

Cleaning the Pet Nozzle

1 Press the nozzle release button **1** to remove the nozzle from the extension pipe or product body.

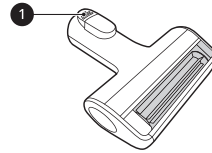

2 Remove the rotating brush while holding down the **PUSH** button on the nozzle.

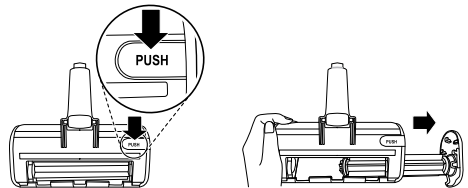

3 Attach the crevice tool to the product body and use the vacuum to remove foreign objects and dust from the brush and the bottom of the nozzle.

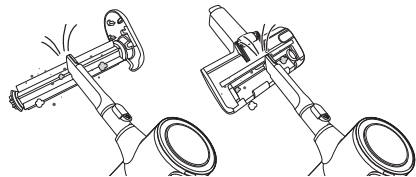

4 Use a damp towel or cloth to remove any remaining foreign objects and dust from the brush and the bottom of the nozzle. Remove foreign objects, debris and hair from all Rollers of the nozzles using tweezers.

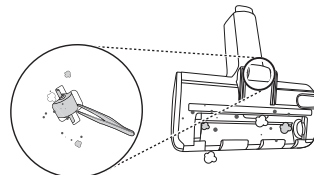

- 5** Insert the left side of the brush **2** into the groove **3** inside the nozzle.

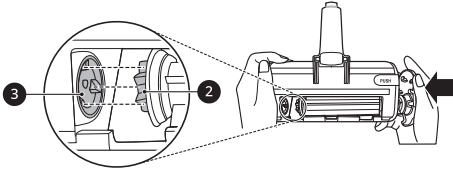

- 6** Press the cover of the brush to lock the brush until a clicking sound is heard.

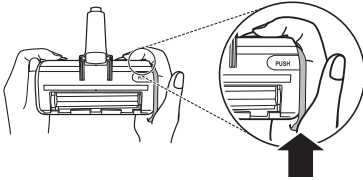

Cleaning the Mop Nozzle

- 1** Press the nozzle release button to remove the mop nozzle from the extension pipe, and turn the nozzle upside down.
- 2** Use a damp towel or cloth to remove any remaining foreign objects and dust from the bottom of the mop nozzle. Remove foreign objects, debris and hair from all nozzle rollers using tweezers.

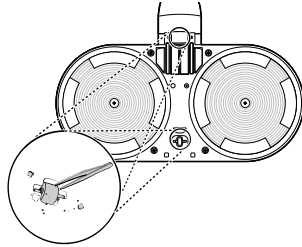

Cleaning the Bedding Nozzle

- 1** Press the nozzle release button to remove the nozzle from the extension pipe or product body and turn the nozzle upside down.
- 2** Attach the crevice tool to the product body and use the vacuum to remove foreign objects and dust from the bottom of the nozzle. Use a damp towel or cloth to remove any remaining foreign objects and dust from the bottom of the nozzle. Remove foreign objects, debris and hair from all Rollers of the nozzles using tweezers.

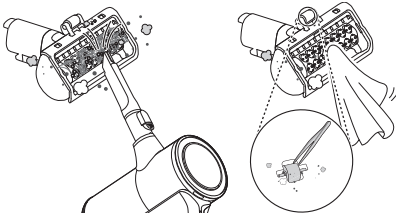

TROUBLESHOOTING

Before Calling for Service

Operation

Symptoms	Possible Cause & Solution
The appliance does not operate.	Battery is fully discharged. <ul style="list-style-type: none"> Charge the battery.
	Appliance is turned off. <ul style="list-style-type: none"> Press the Power button to turn on the appliance.
Suction power is too weak.	Dust bin is full of dust. <ul style="list-style-type: none"> Empty the dust bin.
	Filters are clogged. <ul style="list-style-type: none"> Clean the pre-filter and the exhaust filter.
	Inlet is clogged. <ul style="list-style-type: none"> Remove any foreign objects from inside the product body or the extension pipe.
	Foreign object is on rotating brush, or in inlet port. <ul style="list-style-type: none"> Remove any foreign objects (thread, hair) from the rotating brush or the inlet port.
The product body does not appear to be charging.	Power cord is unplugged. <ul style="list-style-type: none"> Plug the power cord securely into the outlet.
	Foreign object is on the charging terminals. <ul style="list-style-type: none"> Remove dirt or foreign objects from the charging terminals with a dry cloth.
Hot air is coming from the product body.	Motor is cooling. <ul style="list-style-type: none"> If the appliance is running normally, the hot air is a result of the motor cooling and is not a sign of malfunction.
The Kompressor lever does not return.	Foreign objects which become lodged in the cyclonic mesh filter may be difficult to dislodge with the Kompressor lever. <ul style="list-style-type: none"> Remove the cyclonic mesh filter and use the cleaning brush, etc. to clean it.
A strange odour is coming from the appliance.	Appliance was purchased within the last 3 months. <ul style="list-style-type: none"> The cleaner may emit a smell of rubber for about 3 months after purchase.
	Dust bin is full of dust. <ul style="list-style-type: none"> The dust in the bin may cause some odour. Empty the bin and clean it.

Symptoms	Possible Cause & Solution
A strange odour is coming from the appliance.	Foreign object is on the filter. <ul style="list-style-type: none"> The filter may emit an odour if it has not been cleaned for some time. Clean the pre-filter and exhaust filter regularly.
	Pre-filter, Exhaust Filter or the Cyclonic Mesh Filter were installed while damp or wet. <ul style="list-style-type: none"> Wash the filters with running water. To avoid odour, allow the pre-filter to dry completely in a well-ventilated area out of direct sunlight for at least 24 hours before reassembling.
	Exhaust filter was installed while damp or wet. <ul style="list-style-type: none"> Wash the exhaust filter with running water. To avoid odour, allow the exhaust filter to dry completely in a well-ventilated area out of direct sunlight for at least 24 hours before reassembling.
The appliance makes too much noise.	Vacuum cleaner is running in Turbo mode. <ul style="list-style-type: none"> The motor may be louder at the higher suction power settings. This is normal.
The appliance turns off unexpectedly or by itself after the motor speed fluctuates repeatedly.	Battery is not fully charged. <ul style="list-style-type: none"> The battery must be fully charged before cleaning. If the problem persists when the battery is fully charged and the pipes and attachments are clear from obstructions, contact an LG customer information centre for service.
	Foreign object is in the product body, extension pipe, inlet port or nozzle. <ul style="list-style-type: none"> Remove any foreign objects from the product body, extension pipe, inlet port or nozzle.
	Filters are clogged. <ul style="list-style-type: none"> Clean the pre-filter and the exhaust filter.
The rotating brush does not rotate.	Brush is improperly installed. <ul style="list-style-type: none"> Remove the brush, clean it if necessary and attach it again.
	Foreign object is on rotating brush. <ul style="list-style-type: none"> If a foreign object becomes stuck in the rotating brush during operation, the rotating brush will stop rotating to protect the brush motor. Turn the product off immediately. Once the product is turned off, remove the foreign object from the rotating brush before resuming use.

Mop Nozzle

Symptoms	Possible Cause & Solution
The mop pad attachment plate does not rotate.	Mop pads are improperly installed. <ul style="list-style-type: none"> Remove the mop pads, clean them if necessary and attach them again.

Symptoms	Possible Cause & Solution
The mop pad attachment plate does not rotate.	Mop nozzle is pressed too hard against the floor. <ul style="list-style-type: none"> The mop attachment plate stops automatically to protect the product. This is not a failure. Attach the mop pads securely to the mop attachment plate and press the power button to resume use.
	Foreign object is between mop attachment plate and mop pads. <ul style="list-style-type: none"> Remove foreign objects from the mop nozzle attachment plate and press the power button to resume use.
There is no liquid coming out of the mop nozzle.	Water tank is empty. <ul style="list-style-type: none"> Fill the water tank. Remove the battery or detach the nozzle before filling the water tank.
	Water tank is improperly attached to mop nozzle. <ul style="list-style-type: none"> Properly attach the water tank to the mop nozzle. Remove the battery or detach the nozzle before properly securing the water tank to the nozzle.
	The detergent outlet was clogged by detergent water scale or other foreign substances. <ul style="list-style-type: none"> Press Move > button for 10 to 15 seconds to make sure water is flowing through the spray mop nozzle. Use a soft brush to gently brush the detergent outlet, or use a damp cloth to wipe the outlet clean. Alternatively, a pin may be used to carefully unclog the outlet if needed.
There is moisture in the water tank.	Water tank is not allowed to dry completely after use. <ul style="list-style-type: none"> Empty the water tank, set it out of direct sunlight, and allow it to dry completely after use.
A strange odour is coming from the appliance.	Foreign object is on the dust inlet of the mop nozzle. <ul style="list-style-type: none"> Wet dust in the mop nozzle may result in odour. Make sure to wipe the dust inlet of the mop nozzle with a wet wipe after each use.
Mop pads make the floor dirty.	Mop pads are not cleaned properly after use. <ul style="list-style-type: none"> Clean the mop pads thoroughly after each use. Using soiled mop pads may make the floor dirtier.
The appliance makes too much noise.	This is the sound generated when the pump at the inlet of the mop is operating. <ul style="list-style-type: none"> This is normal.
	The mop pads were improperly attached on the plates. <ul style="list-style-type: none"> Align and attach the centre of the mop pad with the centre of the mop attachment plate.

Wi-Fi

Symptoms	Possible Cause & Solution
<p>Your home appliance and smartphone are not connected to the Wi-Fi network.</p>	<p>Battery is fully discharged.</p> <ul style="list-style-type: none"> • Charge the battery, then register your appliance on LG ThinQ.
	<p>The password for the Wi-Fi that you are trying to connect to is incorrect.</p> <ul style="list-style-type: none"> • Find the Wi-Fi network connected to your smartphone and remove it, then register your appliance on LG ThinQ.
	<p>Mobile data for your smartphone is turned on.</p> <ul style="list-style-type: none"> • Turn off the Mobile data of your smartphone and register the appliance using the Wi-Fi network.
	<p>The wireless network name (SSID) is set incorrectly.</p> <ul style="list-style-type: none"> • The wireless network name (SSID) should be a combination of English letters and numbers. (Do not use special characters.)
	<p>The router frequency is not 2.4 GHz.</p> <ul style="list-style-type: none"> • Only a 2.4 GHz router frequency is supported. Set the wireless router to 2.4 GHz and connect the appliance to the wireless router. To check the router frequency, check with your Internet service provider or the router manufacturer.
	<p>The distance between the appliance and the router is too far.</p> <ul style="list-style-type: none"> • If the distance between the appliance and the router is too far, the signal may be weak and the connection may not be configured correctly. Move the location of the router so that it is closer to the appliance.

Memo

Memo

Memo

