

KDD90CNE



Product family	Hood
Hood Type	Fully Integrated hood
Design	Fully integrated
Extraction	Extraction
Electronic control	Yes
Perimeter extraction	Yes
Material	Glass
Type of steel	Brushed
EAN code	8017709305796
Hood width	90 cm



Aesthetics



Aesthetic	Universale	Glass Type	Black
Colour	Black	Serigraphy colour	Silver
Finishing	Satin	Logo	Silk screen

Controls



Control setting	Touch control	Display	Digital
Led color	Red		

Programs / Functions

No. of speeds	4
Intensive speed	
24h air filter function	
Time-setting options	

Technical Features



Remote motor	KITRBDD - Kit Optional	Free outlet maximum capacity	725 m ³ /h
No. of lights	1		

Light type	LED	Motor power	270 W
Light Power	7 W	No. of filters	2
Dimmer mode	Yes	Anti-grease filters	Aluminium
Light color temperature scale (°K)	4000 °K	Filter replacement indicator	Yes
		Vent outlet	150 mm

	Extraction rate IEC 61591 [m³/h]	Noise level IEC 60704-2-13 [dB(A)]
Speed 1	160	40
Speed 2	290	53
Speed 3	350	54
Speed 4	430	60
Intensive speed	700	70

Accessories Included

Sliding door	Yes	Tube reduction	Yes
---------------------	-----	-----------------------	-----

Performance / Energy Label

Annual Efficiency Consumption (AEChood)	58 kWh/a	Airborne acoustical A-weighted sound Power Emission at maximum speed (SPEmax)	54 dB(A)
Energy efficiency class (EEC)	A	Airbourne acoustical A-weighted sound power emission at boost speed (SPEboost)	70 dB(A)
Fluid Dynamic Efficiency (FDE)	30	Power Consumption in Off mode (Po)	0.49 W
Fluid Dynamic Efficiency class (FDEC)	A	Time increase factor (F)	0.9
Lighting Efficiency (LE)	29 lux/W	Energy Efficiency Index	53.8
Lighting Efficiency Class (LEC)	A	Measured air flow rate at best efficiency point (Qbep)	397 m³/h
Grease Filtering Efficiency (GFE)	65.1 %	Measured air pressure at best efficiency point (Pbep)	441 Pa
Grease Filtering Efficiency Class (GFEC)	D	Measured electric power input at best efficiency point (Wbep)	162 W
Air flow at minumum speed (Qmin)	160 m³/h	Nominal Power consumption of the light system (WL)	7 W
Air flow at maximum speed (Qmax)	350 m³/h	Average illumination of the light on the cooking surface (Emiddle)	200 lux
Air flow at boost speed (Qboost)	700 m³/h		
Airbourne acouistical A-weighted sound Power Emission at minimum speed (SPEmin)	40 dB(A)		

Sound power level at highest setting (Lwa)

54 dB(A)

Electrical Connection

Plug (F;E) Schuko
 Electrical connection rating 277 W
 Voltage 220-240 V

Frequency (Hz) 50-60 Hz
 Power supply cable length 1500 mm

Also available

Alternative colours available

White, Silver Glass

Available colours

KDD90VXBE - KDD90VXSE

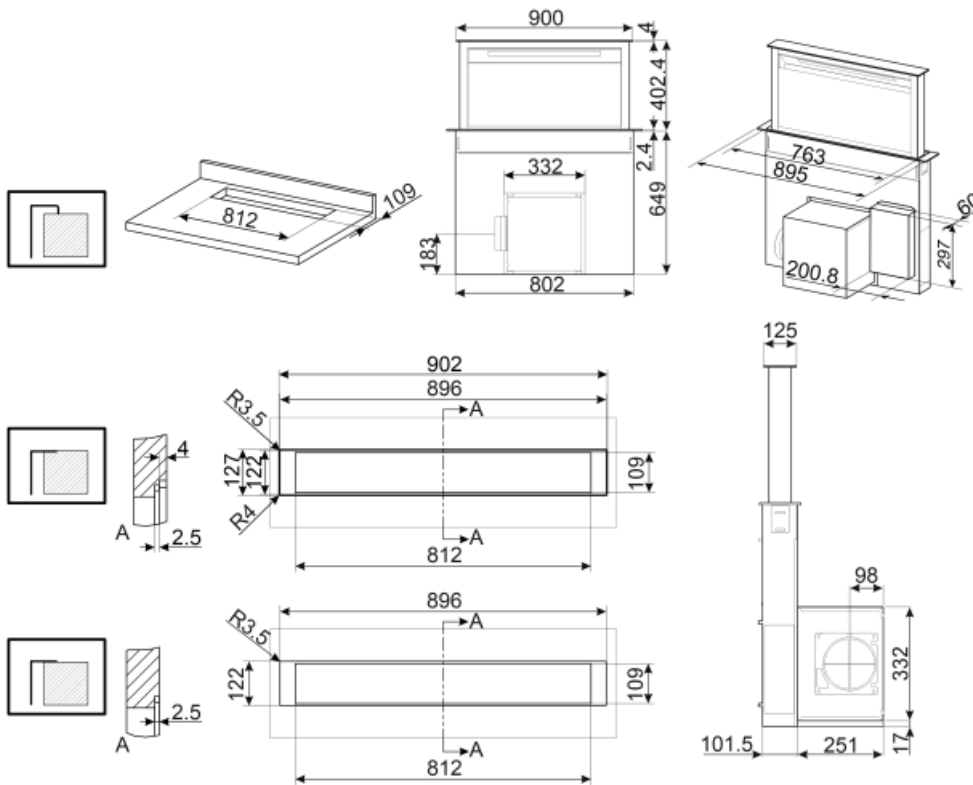

Not included accessories



KITFCDD

Charcoal filter for hood Down Draft Kit 1 piece Dishwasher safe

KITRBDD











kit remote blower for DD hood



RCKF2

Remote control

Symbols glossary (TT)

	24h: When selected this function refreshes the air for c. 10 minutes every hour over a 24 hour period, at minimum speed and an imperceptible noise level.		A: Product drying performance, measured from A+++ to D / G depending on the product family
	Filters: Model has filters to help remove grease from the steam emanating from the pans during cooking.		Switch off automatically: A special setting, to run after the end of cooking for a pre-set time and then switch off automatically.
	Electronic display: to give a visual reminder of the options selected.		Warning light(s): to advise when filters need changing.
	Lights: All cooker hoods feature lights to illuminate the cooking area or add to the ambience of the kitchen.		Perimeter extraction panels: very efficient and aid noise reduction.
	Touch controls: Easy to use touch controls allow the appliance to be programmed at the touch of a button.		Intensive/turbo setting: when extra fast extraction is required.
	...		