

Instructions for use

TRD5 Series

DRAGON
EASYTRONIC



DESCRIPTION	3
USE.....	4
Easy wheel system	4
Location	4
Power connection	4
APPLIANCE OPERATION AND USE.....	5
Turn ON the appliance.....	5
Functioning.....	5
<i>Eco Power</i> function	6
TIMER	7
Timer function.....	7
ALARMS	8
TROUBLESHOOTING	8
MAINTENANCE	9
Maintenance	9
Technical characteristics.....	9

Dragon Easytronic Description

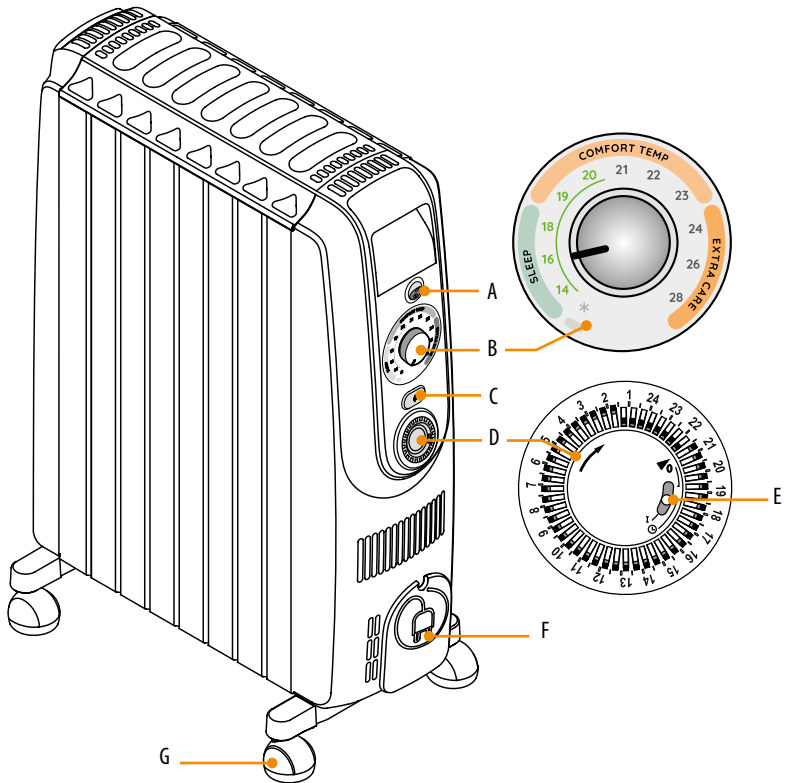

- A.** ON-OFF switch with indicator light
- B.** temperature control knob
- C.** power limit button
- D.** timer (some models only)
- E.** selector
- F.** cord holder
- G.** wheels

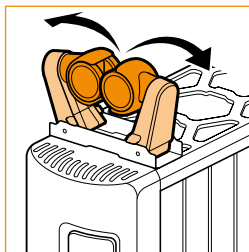

Easy wheel system

- Turn the radiator upside down on a rug or a soft surface in order to prevent damaging the paint finish.
- Fully unfold the wheels by turning them outwards.
- Turn the radiator back to its upright position.

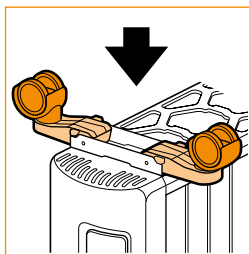

Location

- The heater must not be placed immediately below a power outlet.
- Do not use this radiator in rooms having a surface area of less than 43 square feet (4 sq.m.).

Power connection

- Before using the appliance check that your supply voltage is the same of that shown on the rating label of the unit and that the power socket and power supply line correspond to the load specified.
- Check also the current capacity of your fuses. **CONNECT YOUR HEATER TO EARTH PROVIDED SOCKET ONLY.**
- Plug in the heater, the appliance will enter the ON status or the OFF status regarding the position of the ON-OFF switch.
- The ON-OFF switch is marked with the On/Off symbol, as reported in the following figure .

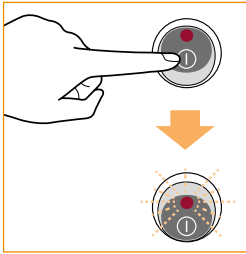

Turn ON the appliance

- To turn ON the appliance, plug in the heater and switch to ON.
- Verify the selector (E) is correctly positioned (see paragraph "Timer function").
- The light will turn on and the appliance will start working based on the set point selected by the temperature knob.
- To turn OFF the appliance turn the switch to the OFF position, the appliance will stop operating and the light will turn off.

Note:

After an interruption of the power supply (power failure or appliance unplugged) the unit restores its previous operation mode selected by the user (also for the activation or deactivation of the power limit function).

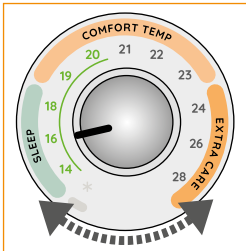

Functioning

- The temperature control knob is designed to guide you to the selection of the room temperature based on your needs. Rotate clockwise or counterclockwise the knob to chose the most suitable temperature following 4 simple sectors:

1. Antifreeze sector:

Setting the temperature to * the appliance will automatically work to keep the room at a constant temperature of 5°C, preventing water pipes from freezing.

2. Sleep sector:

It allows to select the temperatures of 14, 16 and 18° C, most suitable when sleeping.

3. Comfort Temp sector:

it allows to select the most preferred comfort temperature between 19-20-21-22-23°C

4. Extra care sector:

it allows to select 24-26-28°C for those situations when a higher comfort temperature is required

- The appliance allows to easily and precisely select among antifreeze and any of the 11 desired room temperatures.
- The appliance will start operating and will stop once the comfort temperature is reached.

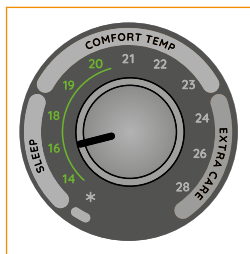

Important:

- When using your appliance, consider avoiding to set the temperature control knob too high. Keeping the room temperature within the temperatures highlighted in green color (within 20°C), will contribute to avoid overheating the home and to reduce the energy consumption.
- Avoid overheating of the room!

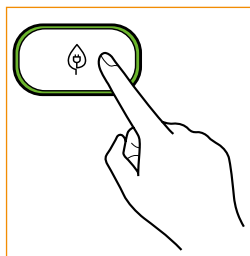

Eco Power function

With this function the unit will work at reduced power level, minimizing the energy consumption.

- To activate this function press the  button.
- When the function is active, the machine operates at a reduced power level.
- When flashing, the Power limit button will display any appliance errors/malfunctions.

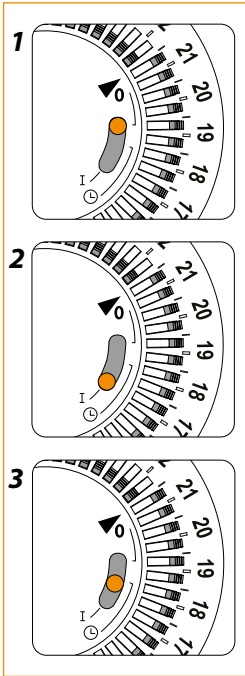

Timer function

It is possible to program the switching on and off of the appliance over a 24 hour period.

The timer has a selector (E) that gives the user the possibility to:

1. Keep the appliance unpowered, by putting the selector on the "0" symbol (1).
2. Keep the appliance powered, by putting the selector on the "I" symbol (2).
3. Use the timer function, by putting the selector on the "C" icon (3).

- As with all clocks, the timer must be set to the exact time.
- For example, if it is 9.30 in the morning, turn the dial of the timer clockwise (in the direction of the arrow) until 9.30 is lined up with the pointer.

IMPORTANT: DO NOT TURN THE DIAL OF THE TIMER ANTICLOCKWISE.

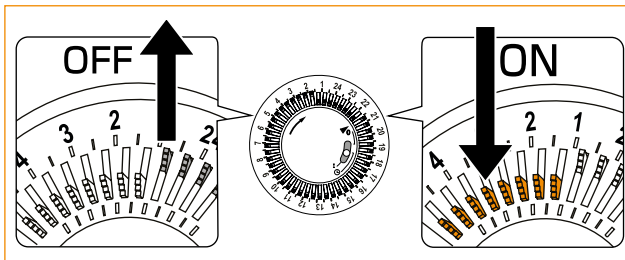

- Each teeth representing a 30 minute period. The appliance can be programmed to come on and go off at set times.
- When a tooth is pushed towards the centre of the dial, the radiator remains in operation for those 30 minutes. If the tooth is pulled out, the radiator is off during that period (see figure below).
- The timer is an electric clock and only works when plugged into a power outlet with the ON/OFF switch (A) set to ON. If the switch (A) is set to OFF, the appliance will not work.

If the appliance is unplugged, the timer stops and must be reset.



Dragon Easytronic Alarms

The appliance has a diagnostic system that makes it possible to signal malfunctions. In case of problems, the  button will lose its power limit meaning and start blinking in order to inform the user about the actual malfunctions.

<p>4 quick flashes, followed by 4 seconds pause (probe failure)</p>	<p>When there is a probe failure the  button starts 4 fast blinkin followed by 4 seconds off</p>	<p>With this alarm the appliance does not operate. Contact the De'Longhi Customer Service.</p>
<p>2-seconds flashes, followed by 2-seconds pause, repeated until the problem is solved (high temperature)</p>	<p>When the product's internal temperature is too high, the heating power will progressively and automatically be reduced. The  button starts a slow single blink, 2 seconds ON and 2 seconds OFF.</p>	<p>To remove the cause of this alarm check that the unit is not covered and let the appliance cool down, by applying a low-temperature setpoint. A safety device switches the heater off in the event of overheating. In case the appliance is not able to automatically restart the heater, call the De'Longhi Customer Service.</p>
<p>Continuous fast flashes, repeated until the problem is solved (tip-over switch)</p>	<p>When the appliance is not placed in a vertical position for more than 3 seconds, it deactivates the heating elements and the  button starts a fast blinking.</p>	<p>When the appliance comes back into normal vertical operation, the appliance behaviour returns to the previous operation mode.</p>

Troubleshooting

<i>PROBLEM</i>	<i>CAUSE</i>	<i>SOLUTION</i>
<p>The indicator light does not turn on</p>	<p>Be sure it is plugged in and that the electrical outlet is working</p> <p>The safety device may have switched off the appliance</p>	<p>Plug into the power outlet</p> <p>Remove the obstruction and let the appliance cool down. If the appliance doesn't work please contact the De'Longhi Customer Service</p>
<p>The appliance doesn't warm up</p>	<p>The temperature may be set too low</p>	<p>Set the temperature to a higher value</p>

Dragon Easytronic Maintenance

Maintenance

- Always remove the plug from the power outlet and allow the radiator to cool.
- Wipe radiator with a soft damp cloth, do not use detergents and abrasives.
- Should the radiator not be in use over a certain length of time, wind the cord around the cord holder and store it in a dry place.
- This appliance has been built to give many years of trouble free service.
- In case of malfunction or doubt, do not try to repair the heater by yourself: this may result in a fire hazard or electric shock. Call the De'Longhi Customer Service (see attached list of De'Longhi Customer Service).

Technical characteristics

Supply voltage

See rating plate

Absorbed power

“

