



the Eye Q 850™ Auto 2 slice

BTA850

Powered by iSensability™

Breville®

 Safety Guide

EN CONTENTS

2. Limited product warranty
2. Breville® recommends safety first
6. Components
7. Unboxing
8. Care and cleaning
9. Toasting
10. Toasting crumpet
11. Manual timer mode
12. Sourdough mode toasting
13. Using A Bit More™ function
14. Volume control
15. QR code web access

LIMITED PRODUCT WARRANTY

2 YEAR LIMITED

Breville's warranty for this product covers the repair or replacement if it's found to be defective due to faulty materials, workmanship, or function within the warranty period.

All legal warranty rights under applicable national legislation will be respected and will not be impaired by our warranty. For details on length of warranty, to obtain a printed copy or to read full terms and conditions please scan the QR code or visit www.breville.com. Alternatively, call the Breville Service Centre (see back cover for contact details)



QR149

BREVILLE® RECOMMENDS SAFETY FIRST

At Breville® we are very safety conscious. We design and manufacture consumer products with the safety of you, our valued customer, foremost in mind. In addition, we ask that you exercise a degree of care when using any electrical appliance and adhere to the following precautions.

IMPORTANT SAFEGUARDS

Read all instructions before use and save for future reference.

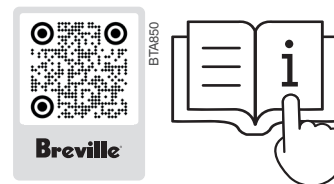

- A downloadable user guide is available at breville.com.
- Before using for the first time please ensure that your electricity supply is the same as shown on the rating label on the underside of the appliance. If you have any concerns, please contact your local electricity company.
- Remove and safely discard any packaging materials before first use.
- To eliminate a choking hazard for young children, safely discard the protective cover fitted to the power plug.
- Do not place the toaster near the edge of a table, counter or bench top during operation.

- Ensure the surface is level, clean and free of water.
- Do not place the toaster on or near a hot gas, or electric burner, or where it could touch a heated oven.
 - The bread may burn, therefore do not use the toaster near or below combustible material, such as curtains. The toaster should be attended when in use.
 - Always ensure the toaster is properly assembled before use.
 - The appliance is not intended to be operated by means of an external timer or separate remote-control system.
 - Ensure that bread to be toasted is the correct size for the toaster and does not protrude above the bread slice opening. Ensure the bread is not too thick or too long that it will jam or wedge the bread carriage.
 - Oversized foods, metal foil packages, or utensils must not be inserted into the toaster as they may cause a fire or risk of electric shock.
 - Metal utensils such as a knife, should not be inserted into the toaster to remove jammed toast, bagels, or any other items from the toaster. This can damage the heating elements as well as lead to electrocution.
 - Do not attempt to dislodge food when the toaster is plugged in.
 - Never cover the toaster whilst it is plugged into the power outlet or while hot.
 - Do not place toast directly on top of toaster slots to warm toast, as this may prevent correct air circulation and damage the toaster.
 - Do not move the toaster while in operation or when hot.
 - The outer housing of the appliance may be hot during and after use. Always keep the power cord of this products and those of other appliances nearby, clear from the housing.
 - Do not use the toaster on a sink drainboard.
 - The appliance is not suitable to be used in a small appliance enclosure. Ensure to leave adequate space all around the appliance.
 - Always switch off at the power outlet, then remove the plug from the outlet and allow cooling the unit completely before storing. Store in an upright position, on a flat surface, on your bench top or in an accessible cupboard. Do not store anything on top of the toaster.
 - Do not use the toaster without the slide out crumb

tray in place. Do not allow breadcrumbs to accumulate in the bottom of the toaster. Failure to clean the crumb tray regularly may result in a fire hazard.

- The toaster crumb tray is not dishwasher safe. Cleaning it in the dishwasher will cause cosmetic damage, product malfunction or even electric shock.
- When heating toaster pastries, always use the lowest shade setting.
- Do not clean with metal scouring pads. Pieces can break off the pad and touch electrical parts creating an electric shock hazard.



CAUTION

To prevent damage to the appliance, do not use alkaline cleaning agents when cleaning, use a soft cloth.

- Keep the toaster clean.
- Do not leave the toaster unattended when toasting.

IMPORTANT SAFEGUARDS FOR ALL ELECTRICAL APPLIANCES

- Fully unwind the power cord before operating.
- Do not let the power cord hang over the edge of a table or counter, touch hot surfaces, or become knotted.
- This appliance is not intended for use by persons (including children) with reduced physical sensory or mental capabilities, or lack of experience and knowledge, unless they have been given supervision or instruction concerning use of the appliance by a person responsible for their safety.
- This appliance can be used by children aged from 8 years and above and persons with reduced physical, sensory

or mental capabilities or lack of experience and knowledge if they have been given supervision or instruction concerning use of the appliance in a safe way and understand the hazards involved.

- Children should be supervised to ensure that they do not play with the appliance.
- Cleaning and user maintenance shall not be undertaken by children unless they are older than 8 and supervised.
- Keep the appliance and its cord out of reach of children less than 8 years.
- This appliance is for household use only. Do not use the appliance for anything other than its intended use. Do not use in moving vehicles or boats. Do not use outdoors. Misuse may cause injury.

- It is recommended to regularly inspect the appliance. Do not use the appliance if the power cord, power plug or appliance becomes damaged in any way. Return the entire appliance to the nearest authorised Breville service centre for examination and / or repair.
- Any maintenance other than cleaning should be performed at an authorised Breville Service Centre.
- The installation of a residual current device (safety switch) is recommended to provide additional safety protection when using electrical appliances. It is advisable that the safety switch with a rated residual operating current not exceeding 30mA be installed in the electrical circuit supplying the appliance. See your electrician for professional advice.
- The appliance must be used on a properly grounded outlet. If you are not sure if the power outlets are properly grounded, please consult your electrician.
- Do not, under any circumstances, modify the power plug or use an adapter.
- Never operate the toaster on its side.
- Never add any food substance to the bread, muffins or crumpets as this can lead to electrocution or fire.
- To prevent electric shock, unplug before cleaning.



To protect against, fire, electric shock; do not immerse the power cord, power plug or appliance in water or any other liquid.



WARNING

- Do not carry or move the toaster by holding the top metal cover between toasting slots as sharp edges may cause injury.



NOTE

This toaster is electronically controlled; the toaster will not operate until it is plugged into a 220/240-volt power point and switched on.



NOT DISHWASHER SAFE



CAUTION



CAUTION HOT SURFACE

SAVE THESE INSTRUCTIONS FOR HOUSEHOLD USE ONLY

COMPONENTS

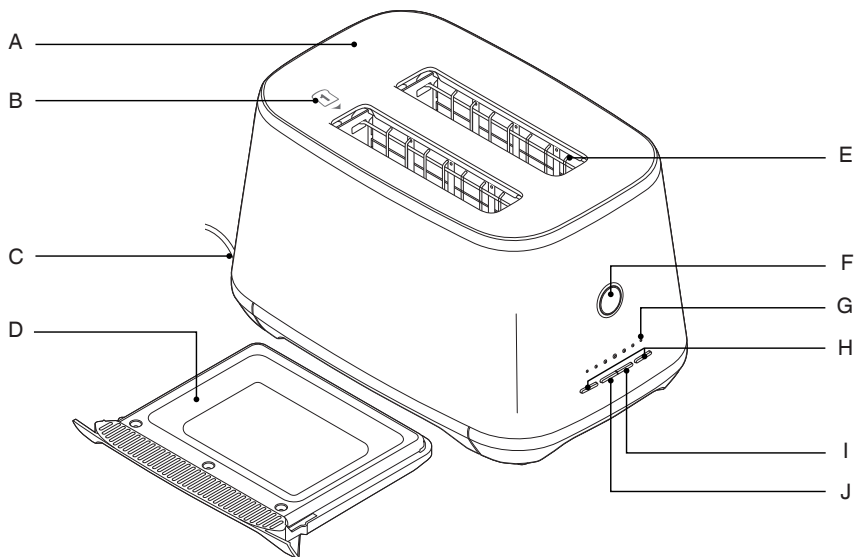

- A. Ceramic coated top cap
- B. Sensing slot - when toasting one piece of bread. This slot contains the optic sensor that accurately detects the colour change of bread during the toasting cycle.
- C. Power cord compartment
- D. Fully removable catch-all crumb tray
- E. Extra wide toasting slots
- F. Motorised start | stop button
- G. LED toast shade selection lights
- H. Plus (+) | Minus (-) shade selection toast buttons
- I. A Bit More™ button
- J. Bagel | Crumpet | English muffin mode button

1. UNBOXING

1.1

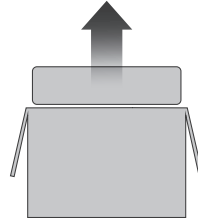

1.2

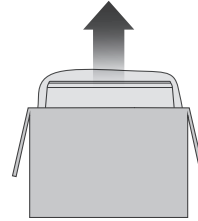

1.3

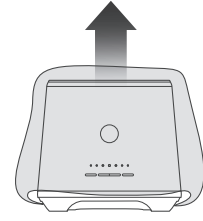

1.4

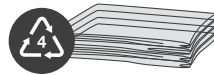
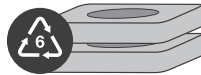
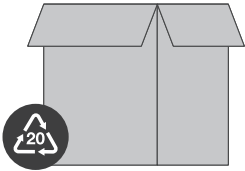

2.

CARE AND CLEANING

2.1

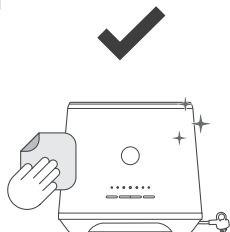

2.2

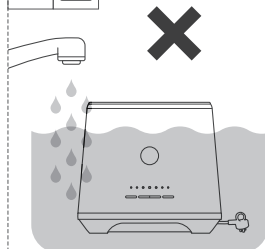

2.3



2.4

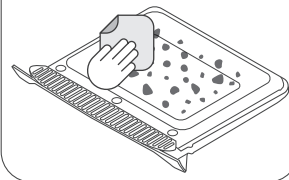

2.5



3. TOASTING

3.1

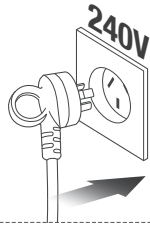

3.2

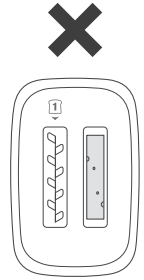
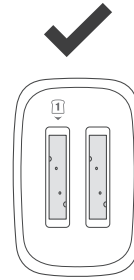
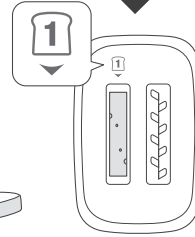
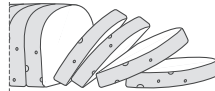

3.3

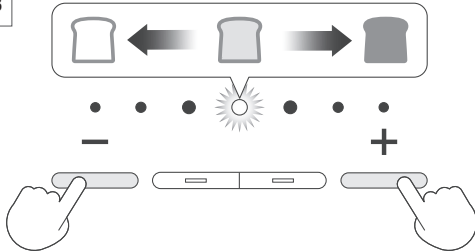

3.4



3.5

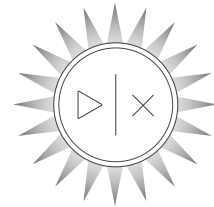
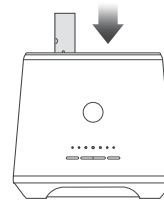

3.6

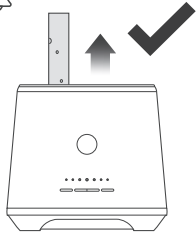

3.7

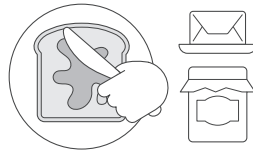

4.

TOASTING CRUMPET

4.1

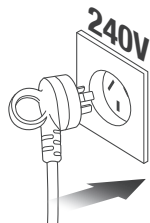

4.2

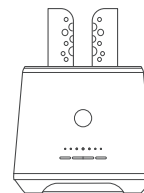
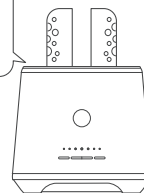
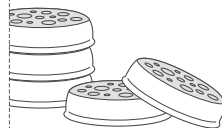

4.3

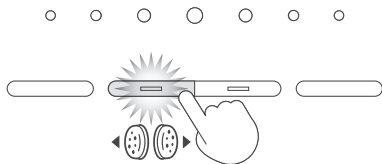

4.4

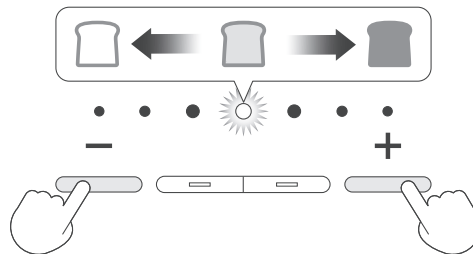

4.5

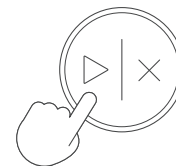

4.6

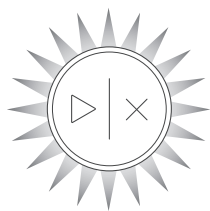
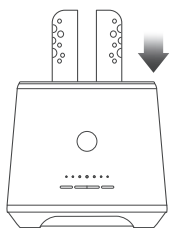

4.7

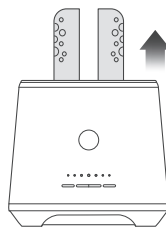

4.8

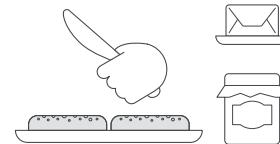

5. MANUAL TIMER MODE

5.1

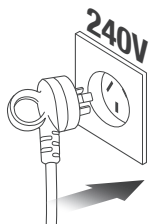

5.2

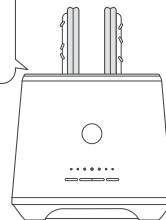
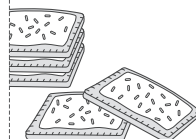

5.3

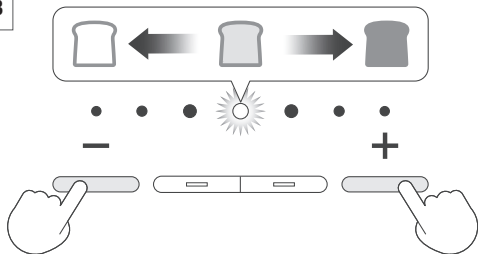

5.4

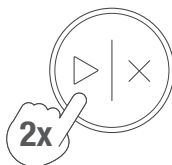

5.5

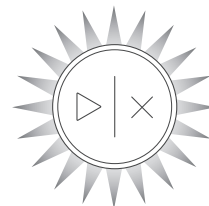
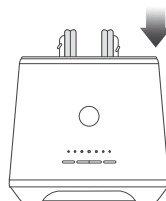

5.6

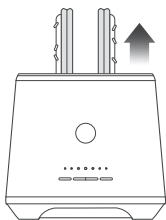

5.7

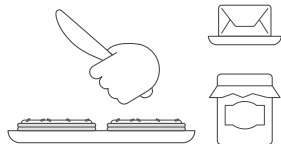

6. SOURDOUGH MODE TOASTING

6.1

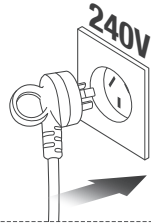

6.2

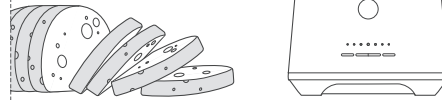

6.3

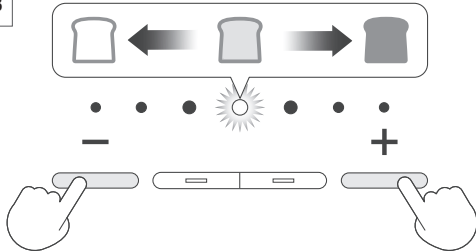

6.4

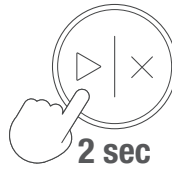

6.5

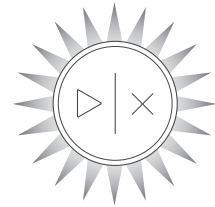
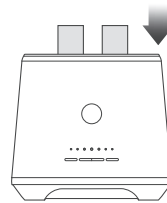

6.6

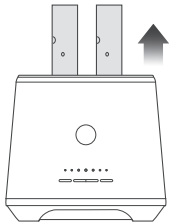

6.7

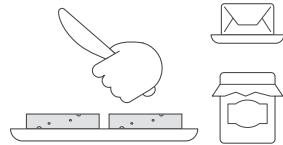

7.

USING A BIT MORE™ FUNCTION

7.1

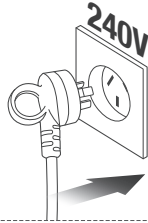

7.2

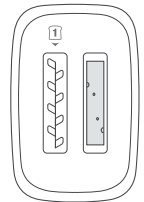
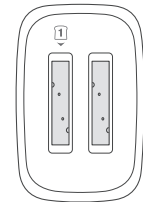
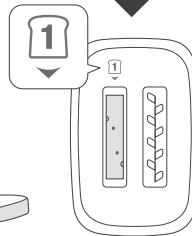
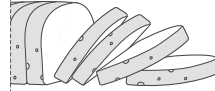

7.3

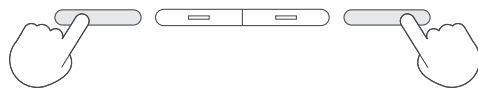

7.4



7.5

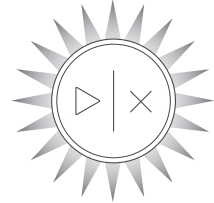
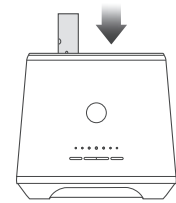

7.6

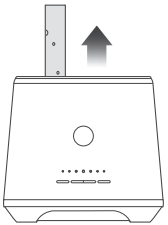

7.7

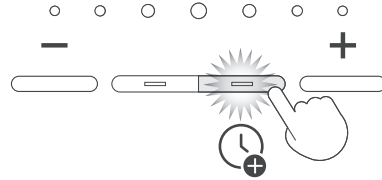

7.8

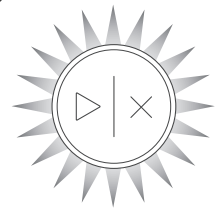
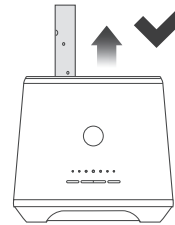

7.9

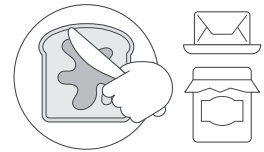

8.

VOLUME CONTROL

8.1

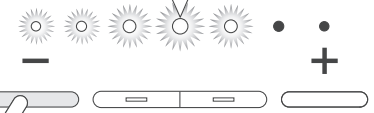

OR

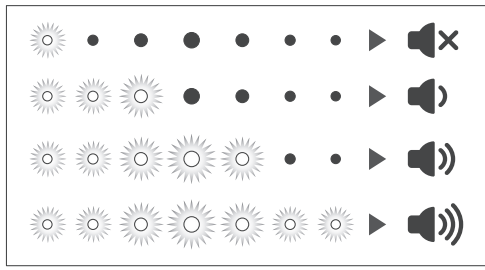
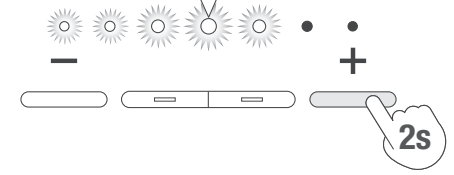

9.



BT850



For more information on:

- Cleaning • Troubleshooting
- Useful Tips and Warranty

Check out the website, visit www.breville.com

Breville Service Center

Australian Customers

Phone: 1300 139 798

Web: www.breville.com

New Zealand Customers

Phone: 0800 273 845

Web: www.breville.com

Breville®

Master Every Moment™

Breville, the Breville Logo, is a trademark of Breville Pty Ltd ("Breville") and Breville's products are distributed in Australia and New Zealand under license. Copyright Breville Pty. Ltd. 2024.

Due to continued product improvement, the products illustrated/photographed in this brochure may vary slightly from the actual product.