

FISHER & PAYKEL

HEAT PUMP CLOTHES DRYER

DH9060D5, DH9060DG5,
DH1060D5 & DH1060DG5 models

USER GUIDE
NZ AU

CONTENTS

Safety and warnings	4
Product overview	8
Control panel	9
Get the best results from your dryer	10
Understanding fibre types	11
Sort your items	12
Load the dryer	13
Select a fibre type	14
Select an item type	15
Select a treatment	16
Select a method	17
Select Dryness	18
Set the cycle	19
More options	20
Save favourite cycles	21
Set delay start	22
Check filter and tank	23
Fit drying rack	24
Wi-Fi connection and Remote Mode	25
Clean and maintain the dryer	26
Emptying the water tank	27
Clean the lint filter	28
Clean the lower filter	29
Troubleshooting	30
Alerts and Fault codes	34
Compliance information	35
Manufacturer's Warranty and Service Guide	36

Registration

To register your product visit our website: fisherpaykel.com/register

SAFETY AND WARNINGS

⚠ WARNING!



Electric Shock Hazard

Failure to follow this advice may result in electric shock or death.

- If you are using an extension cord or a portable electrical outlet device (eg multi-socket outlet box), ensure that it is positioned so that it does not come into contact with water or moisture.

⚠ WARNING!



Fire Hazard

- Only dry fabrics that have been washed with water.
- Do not use heat to dry articles containing foam rubber or similarly textured rubber-like materials.
- Never stop a tumble clothes dryer before the end of the drying cycle unless all items are removed and spread out in order to dissipate the heat.
- A clothes dryer produces combustible lint; the lint filter must be cleaned before each drying cycle.
- Failure to follow the warnings outlined in these user instructions can cause a fire hazard.
- Failure to follow these instructions can result in death or personal injury.

⚠ WARNING!



R290

This appliance contains flammable refrigerant isobutane (R290).

READ AND SAVE THIS GUIDE

WARNING!

Read Safety Guide. Failure to follow all guides and rules could cause personal injury or property damage. Use this appliance only for the intended purpose as described in the user guide and installation guide of this appliance. When using this appliance, always exercise basic safety precautions including the following:

General

- Do not touch or operate the appliance with wet hands or with bare feet.
- A damaged power cord must be replaced by a Fisher & Paykel trained and supported service technician or similarly qualified person in order to avoid a hazard. Do not use the machine until it has been repaired to avoid a risk of electric shock.
- Do not operate this appliance if it has been damaged during transport. Contact your Fisher & Paykel dealer or Fisher & Paykel trained and supported service technician.
- This product has been designed for personal, family or household use. This product is not designed for any commercial use. Any commercial use will terminate this products manufacturer's warranty.
- This appliance is not intended for use by persons (including children) with reduced physical, sensory or mental capabilities, or lack of experience and knowledge, unless they are supervised or given instructions on how to use the appliance by someone responsible for their safety.
- Supervise children to ensure they do not play with the appliance or climb inside the drum.
- Do not swing on or put weight on the door.
- Undergarments that contain metal reinforcements should not be placed in the dryer. Damage to the dryer can result if the metal reinforcements come loose during drying. If you wish to dry these items use a drying rack or place in a garment bag.
- Check and remove all objects from pockets, eg lighters and matches.
- Items should go through the cooling phase in the final part of the cycle. This ensures items are left at a temperature where they will not be damaged. If for any reason the cycle is stopped before it has finished, dry clothes should be removed immediately and not left in the appliance. Items should be quickly spread out flat to cool so heat can dissipate, not left bunched up, eg in a clothes basket or in a pile.
- In the event of a power outage the cycle will be paused when power is restored. Press Start/Pause, then press the dial to resume the cycle.
- The only user-removable parts of the dryer are the filters, water tank and drying rack. No other parts are designed to be removed by anyone other than a Fisher & Paykel trained and supported service technician.
- For problems that cannot be solved from information in the user guide, turn off and unplug your appliance and contact a Fisher & Paykel trained and supported service technician.
- Never attempt to repair the appliance yourself.
- Never put dripping wet clothes in or on top of the dryer as excess water may cause an electrical hazard.
- Do not under any circumstances place an electric blanket or any other electrical, plastic or rubber items in the appliance, unless the care label specifically states it is safe to do so.
- Do not overload your dryer beyond its rated capacity.

SAFETY AND WARNINGS

MODEL	MAXIMUM CAPACITY* (KG)
DH9060D5, DH9060DG5, DH1060D5 & DH1060DG5	9; 10

*Capacity refers to the maximum dry weight of items the dryer can dry at any one time

- Do not dry curtains in your dryer.
- For models with a water tank, never run the dryer without the water tank in place unless drain hose is connected. For models without a water tank, the drain hose must be connected.
- Do not use the water collected in the water tank for drinking or food processing.
- If the water tank becomes full, the appliance will pause and sound an alarm. You must empty the water tank before the appliance can continue running.

Lint

- Do not operate this appliance without the lint filters in place, or allow lint to accumulate in or around the appliance.
- Accumulated lint in the appliance can become a fire hazard; it also reduces the efficiency of the appliance by causing longer drying times and increased power consumption.
- Clean the lint filter before every load.
- Ensure the area around the appliance is clear of lint.
- If the lint filter becomes damaged, contact your Fisher & Paykel trained and supported service technician to arrange getting a new filter. Do not operate your appliance with a damaged lint filter or without the filter in place, as this will cause damage to your appliance.

Spontaneous combustion

To reduce the risk of fire the following should be observed:

- Items that have been spotted or soaked with vegetable oil or cooking oil are a fire hazard and should not be placed in the appliance.
- Oil-affected items can ignite spontaneously, especially when exposed to heat sources such as this appliance. The items become warm causing an oxidation reaction in the oil. This oxidation creates heat. If the heat cannot escape the items can become hot enough to catch fire. Piling, stacking or storing oil-affected items can prevent heat from escaping creating a fire hazard.
- If it is unavoidable that fabrics that contain vegetable oil, cooking oil or have been contaminated by hair care products be placed in this appliance, they should first be washed in hot water with extra detergent—this will reduce, but not eliminate the fire hazard. The cooling cycle should be used to reduce the temperature of these items. They should not be removed from the appliance and piled or stacked while hot.
- Items that have previously been cleaned in, washed in, soaked in or spotted with flammable liquids or solids, eg petrol/gasoline, kerosene, dry cleaning solvents, vegetable or cooking oil, acetone, denatured alcohol, some brands of spot removers, turpentine, waxes and wax removers or other flammable or explosive substances should not be placed in the appliance.
- The appliance is not to be used if industrial chemicals have been used for cleaning.
- Fabric softeners or similar products should not be used in the appliance to eliminate the effects of static electricity, unless this practice is specifically recommended by the manufacturer of the fabric softener product.

SAFETY AND WARNINGS

- Items such as foam rubber (latex foam), shower caps, rubber backed articles, clothes or pillows fitted with foam rubber pads, waterproof textiles, shoes containing rubber or plastic items should not be placed in the appliance. These materials can spontaneously combust when heated.
- Do not dry unwashed items in the appliance.
- When using REFRESH cycles on unwashed clothing ensure there are no flammable substances on them.

Installation

- This appliance is heavy. We recommend two persons to move and install the appliance.
- The appliance must not be supplied through an external switching device, such as a timer, or connected to a circuit that is regularly switched on and off by a utility.
- We do not recommend the use of extension cords or portable electrical outlet devices for safety reasons.
- Install the appliance on a solid and level floor surface.
- The appliance must be installed in a well-ventilated, dust-free environment.
- The appliance must not be installed on any textured floor coverings (eg carpet, rugs). Ensure that openings at the base of the appliance are not obstructed.
- The appliance must not be installed behind a lockable door, a sliding door or a door with the hinge on the opposite side to that of the tumble dryer, in such a way that a full opening of the tumble dryer door is restricted.
- If installing behind a cabinetry door, it must be hinged on the same side as the dryer and there must be a minimum clearance of 40mm from the front of the dryer door to the internal face of the cabinetry door for the product to operate safely. The enclosed space must be provided with sufficient ventilation to meet local building code requirements or the door must be open while the product is operating.
- This appliance can be installed on a compatible Fisher & Paykel plinth. To ensure stability, the plinth must be fitted correctly with the appliance. For installation instructions and compatible plinth models, refer to fisherpaykel.com.
- Do not install or operate this appliance on any other plinth or structure.
- For more information refer to the installation guide. To access, go to fisherpaykel.com/ specify and search by appliance type, product name or model.

Water supply requirements

- Inlet water pressure: Max. 1MPa (145psi), Min. 30kPa (4.5psi)
- Inlet water flow rate: Min. 6 litres/minute
- The cold water temperature should not exceed 35°C. Temperatures above these may cause the appliance to fault or cause damage to it.
- A pressure-reducing valve must be installed if pressure is higher than 1Mpa.
- New hose sets provided should be used to connect the appliance to the water mains. Old hose sets should not be re-used.
- We recommend the inlet hose(s) are changed every 5 years. WARNING: Failure to do so may result in a flood and damage to property.

Disposal

- When disposing of this appliance, it is recommended that the door is removed to avoid children getting trapped inside and that the electrical cable is cut off close to the dryer.

PRODUCT OVERVIEW

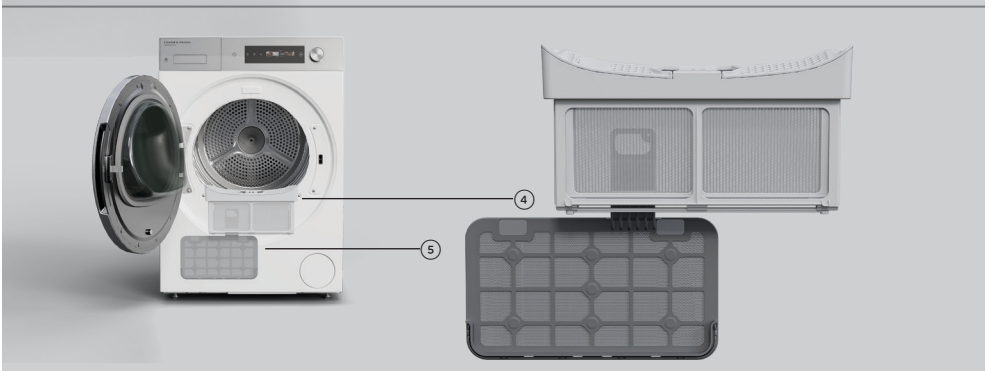







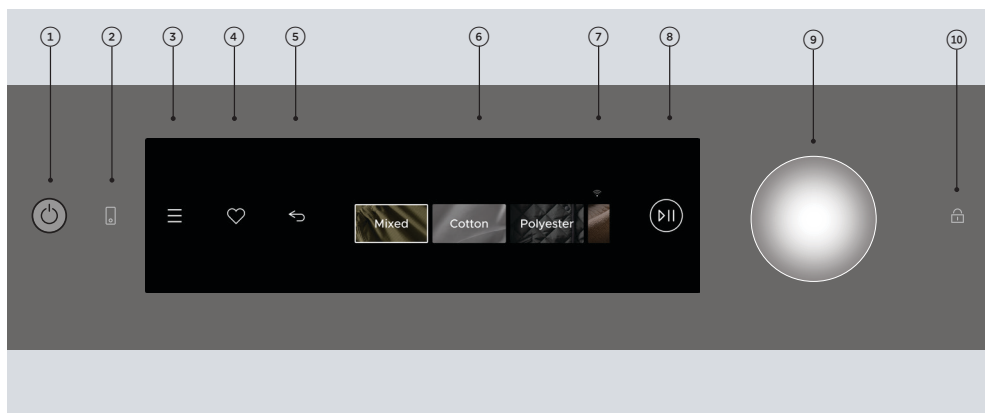





FEATURES AND ACCESSORIES

- ① Control panel
- ② Water tank
- ③ Drying rack (not shown)
- ④ Lint filter
- ⑤ Lower lint filter (under lint filter)
- ⑥ Drum light (inside drum)

CONTROL PANEL



① Power	Press and hold POWER  to turn the washer on/off.
② Remote	Press REMOTE  to connect to Wi-Fi and control your appliance via the app.
③ Menu	Press MENU  to access additional features and settings.
④ Favourites	Press FAVOURITES  to save cycles for quick access.
⑤ Back	Press BACK  to go back to the previous screen.
⑥ Display	Displays product features and settings.
⑦ Wi-Fi	Wi-Fi indicator  lights up when appliance is connected to Wi-Fi.
⑧ Start/Pause	Press START/PAUSE  to start or pause a cycle.
⑨ Control dial	<ul style="list-style-type: none"> • Turn the dial to scroll. • Press to select. • Press to start a cycle after pressing START/PAUSE .
⑩ Key lock	Press and hold KEY LOCK  to lock or unlock the controls. When locked, KEY LOCK  will be illuminated. POWER  and START/PAUSE  will still be available.

GET THE BEST RESULTS FROM YOUR DRYER



Get the app for a smarter experience

- Access extra features and information
- Track and run cycles from your phone
- Customise your favourite cycles
- Get the latest software updates
- Register your product for streamlined support

Heat pump versus vented dryer

Your heat pump dryer is different to a traditional vented dryer. Heat pump technology dries your items at a lower temperature than a vented dryer to ensure gentle, energy-efficient fabric care without overdrying your items.

Get to know your dryer

Take the time to become familiar with cycle selections and how they suit your items. Save your favourite cycles for quick and easy access on the product or in the app, and clean and maintain your dryer to keep it performing at its best.



Recognising post-dryer feel

Items may feel slightly damp when first removed from a heat pump dryer, but they will feel completely dry within a few minutes and are ready to wear immediately. If you prefer your items to feel completely dry as soon as the drying cycle ends, you can adjust the dryness level. See 'Select Dryness'.

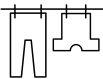

Finishing air-dried items in the dryer

Use a **TIME DRY** cycle for at least 30 minutes to finish partially dry items. This allows time for the dryer to reach temperature.



Loading items directly from the washing machine

Make sure items have been through a spin cycle to remove excess water before placing them in the dryer. Overly wet items will extend the drying cycle and may affect drying performance.

UNDERSTANDING FIBRE TYPES

Every cycle starts with fibre type

Each fibre type responds differently to washing and drying. This appliance uses a fibre-led system and precision sensing to dry your items, so selecting the right fibre type for each load is key to setting the best cycle each time.

Treat for the most delicate fibre

Items may be a blend of multiple fibres — some more delicate than others. The care label on an item will tell you what fibre or fibres the item is made of and how to care for it.

Select the fibre type on your dryer that applies to the most sensitive or delicate fibre in the blend, even if it is only a small percentage.

Identify delicate fibres

This table helps identify the most delicate or sensitive fibres commonly found on care labels. It also offers alternative cycle suggestions for most specialist fibres.

Recommendations may not suit all items — always check your care label first.

SENSITIVITY	COMMON FIBRE TYPES	FIBRE TYPE	ITEM TYPE
	Cashmere	Not suited for machine drying in this model	
	Down	Down	
	Silk	Not suited for machine drying in this model	
	Wool, Merino	Wool	
	Elastane, Lycra	Elastane	
	Viscose, Bamboo, Rayon, Modal	Cotton	Delicate
	Lyocell, Tencel™	Cotton	
	Acrylic	Polyester	
	Linen	Cotton	Denim
	Ramie	Cotton	Delicate
	Nylon, Polyamide	Elastane	
	Polyester	Polyester, Mixed	
Low	Cotton	Cotton, Mixed	

SORT YOUR ITEMS

Sorting your items well is essential for taking care of your clothes and getting the best results from your dryer. Follow these steps every time you use the dryer:



1. Check each care label to see the fibre composition and how each garment should be dried. Always follow the care label advice.

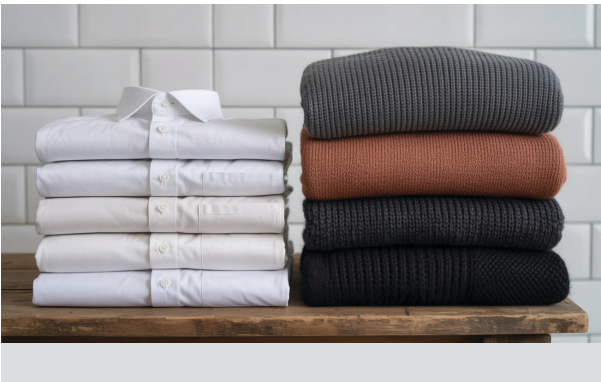

2. Sort items into loads of similar fibre, durability and item type.



3. Check pockets, secure fasteners and untangle items before loading. Allow enough room for items to tumble freely.

LOAD THE DRYER

Maximum load size

The maximum load size changes based on the type of items in a load. Follow the guide below to avoid overfilling the dryer and to maintain good drying performance.



ITEM TYPES		MAX LOAD SIZE
Mixed, Cotton, Polyester	Delicate	Small
	Moderate, Durable	Large
	Denim, Sports, Sheets, Towels	Medium
Wool	Delicate	Small
Elastane	Delicate	Small
	Moderate	Medium
Down	Delicate	Medium
Other Treatments	Rack dry	1 or 2 items
	Refresh	1 or 2 items
	Sanitise	Medium
	Allergy care	Medium to large

SELECT A FIBRE TYPE

Select the specific fibre type that matches the load or choose the fibre type that applies to the most delicate fibre. The drying cycle will adjust to suit. See 'Understanding fibre types' for guidance about which fibre types are the most delicate or most sensitive to drying.

Mixed

For everyday mixed loads with a variety of fibres, and for cotton-polyester blends.

Cotton

For 100% cotton loads.

Polyester

For 100% polyester items.

Wool

For 100% woollen items and wool blends. This cycle meets the Woolmark requirements for machine washable items.

Elastane

For items containing 10-50% elastane fibre, also known as spandex.

Down

For items containing down fill.

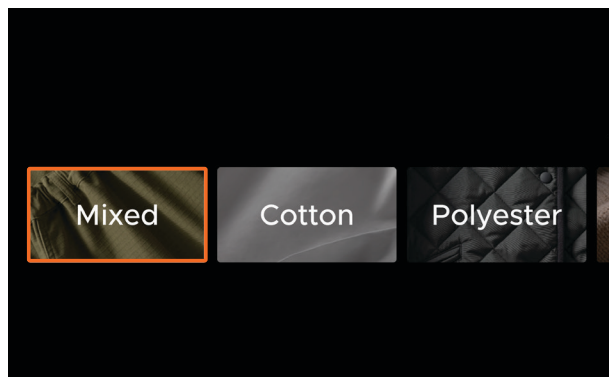

1. Press and hold **POWER**  to turn the dryer on, then scroll to select a fibre type.

Press the dial to confirm the selection.

SELECT AN ITEM TYPE

Item type relates to the durability of items in your load in terms of fabric thickness. Dry garments and items of similar thickness together to prevent some items becoming over-dried while others are still damp.

Delicate

Light and easily damaged or torn items like blouses, dresses and other items.

Moderate

Everyday items like t-shirts, shirts, lined dresses, shorts, pants and denim.

Durable

Strong and resilient everyday items like workwear and outerwear.

Denim

Items made of denim or stretch denim such as jeans, jackets and skirts.

Sports

Durable sportswear items made from synthetic fibre blends.

Sheets

Items such as bed sheets, pillow cases and duvet covers.

Towels

High absorbency towelling fabric items like bath, beach and hand towels.



2. Select an item type.

SELECT A TREATMENT

Rack dry

For items that cannot be tumbled. This option requires the drying rack to be fitted. See 'Fit drying rack' for details.

Dry

Designed for everyday drying.

Refresh

A quick steam treatment to refresh dry items. Recommended for no more than two items.

Sanitise

High temperature drying to eliminate bacteria*. Ideal for towels and sheets, but unsuitable for delicate items.

*Independently tested to eliminate greater than 99.9% of staphylococcus aureus and E. coli using the Cotton, Item Type: Moderate, Treatment: Sanitise, Method: Auto, Dryness: Extra Dry drying options.

Allergy care

Uses sustained higher temperatures to reduce allergens like dust mites and pollen. Ideal for helping to manage allergies or sensitive skin.



3. Select a treatment.

SELECT A METHOD

You can select a drying method that automatically ends the cycle when the load reaches the selected dryness level or after a set duration.

Auto

Ends the cycle automatically when the load reaches the selected dryness level.

Not available for **WOOL** cycle.

Time

Ends the cycle after a set duration. You will be prompted to set a drying duration for the next step. **DRYNESS** is not available with this option.



4. Select a method.

If **AUTO**, set **DRYNESS** next. If **TIME**, set a duration.



Setting duration

After selecting **TIME**, scroll to set your preferred drying duration from 30 to 150 minutes, and press the dial to select.

SELECT DRYNESS

Dryness options let you select a dryness level that prepares items for storing, wearing or ironing. Sensors in the dryer can detect remaining moisture in the load and will end the cycle when the load reaches your preferred dryness level.

Not available for all cycles or if drying method is set as **TIME**.

Iron ready

Leaves some moisture in the load to help reduce wrinkles and prepare items for ironing.

Dry

Dries the load thoroughly leaving items ready to wear.

Dry plus

Ideal for thicker fabrics or absorbent items that might need extra drying time.

Extra dry

An ultra-dry option for thick or heavy items. Ideal for thick or heavy items, or items that are going to be placed in storage.

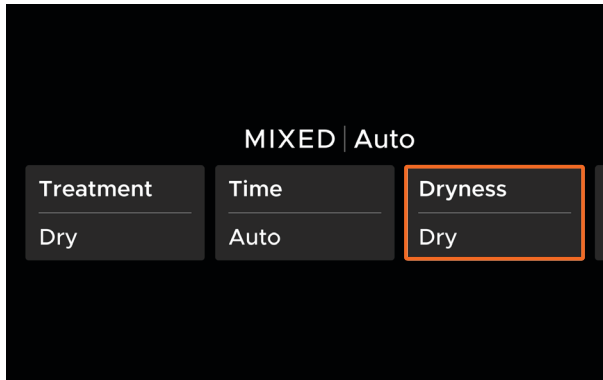

5. Select a dryness level. Press the dial to confirm selection.

SET THE CYCLE

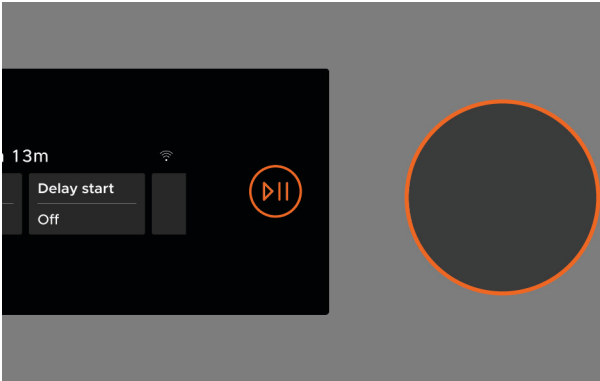

6. Press **START/PAUSE** , then press the dial to start or pause the cycle.

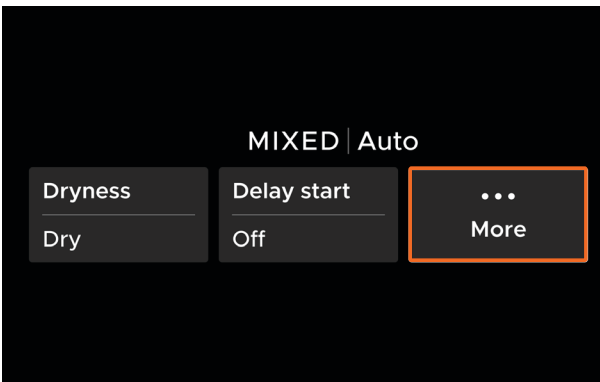

More drying options

Press **MORE** to access further drying options. See 'More options' for details.

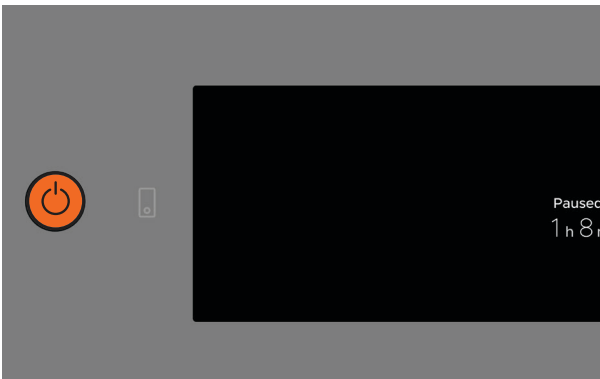

Cancelling the cycle

Press **POWER**  to turn the dryer off and cancel the cycle. Remove items immediately and spread them out to cool. Take care as the drum and items may be hot.

MORE OPTIONS

Access extra wash options and optimisers in the app

- **IRON READY ALERT** - Set an alert for when the load reaches the iron ready stage.



Crease free

Press **CREASE FREE** to turn Crease free on or off.

This tumbles the load periodically after the cycle to reduce creases in items.

Runs for 12 hours or until turned off.

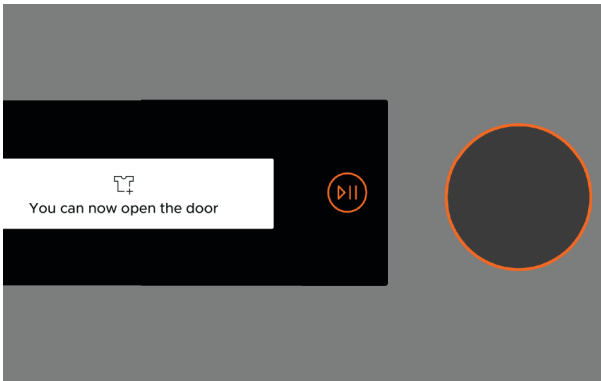

Add Item

Press **START/PAUSE** **▷||** to pause the cycle, then press the dial to unlock the door and add an item.

To resume the cycle, press the dial, then **START/PAUSE** **▷||**, then press the dial again.

SAVE FAVOURITE CYCLES

Save your favourite cycles for a quick start to your drying cycle. Favourites comes with a preset **COTTON REFRESH** cycle. You can save up to 9 more in the app.

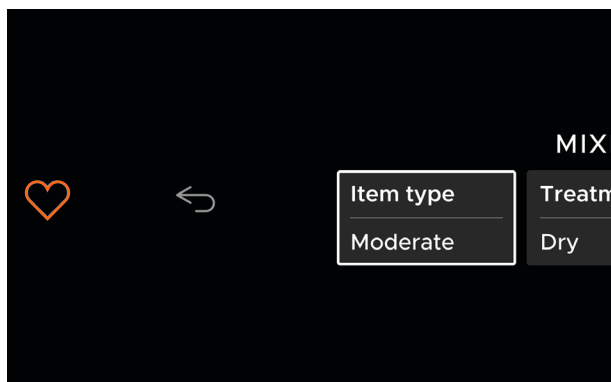

Save a Favourite at cycle setup

Select your cycle settings, then press and hold **FAVOURITE**  to save the cycle.

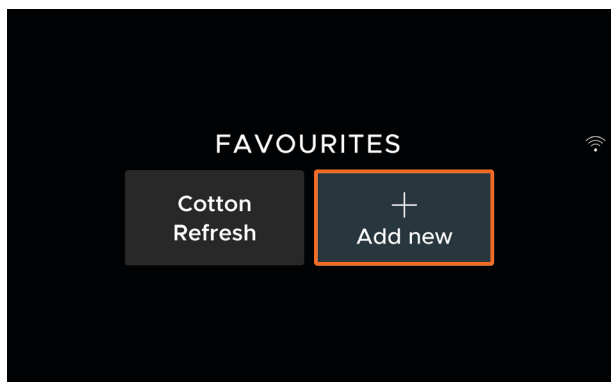

Add a Favourite

Press and hold **FAVOURITE**  on the home screen to go to Favourites menu.

Select **ADD NEW** and follow the onscreen prompts to set up and save a cycle.



Use a saved Favourite

Press and hold **FAVOURITE**  to access the Favourites menu. Scroll to saved cycle and press the dial to select.

Press **START/PAUSE**  to confirm and press the dial to start the cycle.

SET DELAY START

DELAY START allows you to schedule a drying cycle to begin after a set duration.





1. After setting the drying cycle, select **DELAY START**.

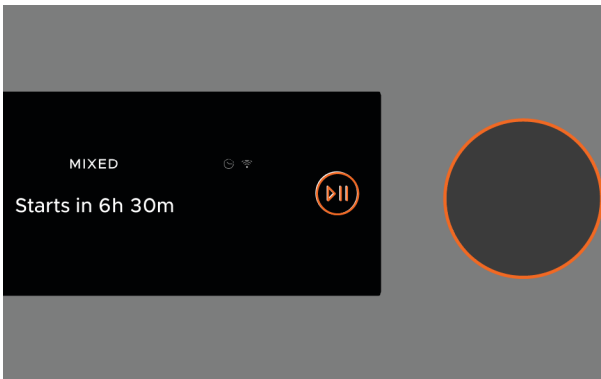

2. Use the dial to set your preferred delay duration, then press the dial to confirm.



3. Press **START/PAUSE** , then press the dial to start the delay countdown. The drying cycle will begin when the countdown ends.

Press **START/PAUSE**  to pause or resume the countdown. Press **BACK**  to cancel the delay.

CLEAN LINT FILTER

Check lint filter after every load.

Press dial to dismiss.

Clean the lint filter

4. The Lint Filter reminder will display after each cycle. Check and empty it after every load.

Go to **MENU** , **SETTINGS** to turn reminders on or off.

See 'Clean the lint filter' and 'Clean the lower lint filter' for details.



WATER TANK FULL

Empty before resuming

Empty the water tank (if not plumbed)

5. The Water Tank reminder will display when the tank is full.

We recommend you check and empty it before each cycle because the drying cycle will stop if the tank fills up mid-cycle.

FIT DRYING RACK

Fit the drying rack when you use the **RACK DRY** option. The rack is designed for items that cannot be tumbled. When **RACK DRY** is selected, you have to set a cycle duration, so **DRYNESS** is not available.



1. Insert the back peg into the rear of the drum, the rack legs into the slots in the lint filter, then lower the rack into place.



2. Place the item/s onto the drying rack, then close the dryer door.

Set relevant **FIBRE TYPE**, **ITEM TYPE** and **TREATMENT: RACK DRY** and **METHOD: TIME** to set desired drying time.

For sneakers, check them throughout the cycle. Save as a Favourite if intending to use this cycle regularly.

WI-FI CONNECTION AND REMOTE MODE

Your appliance may be connected to your home wireless network and operated remotely using the app. Connect your appliance to ensure it stays up to date with the latest software and features.

Getting started

- Ensure your home Wi-Fi network and Bluetooth on your mobile device are turned on.
- You will be given step-by-step guidance on your mobile device.
- It may take up to 10 minutes to connect your appliance.
- For further guidance and troubleshooting, please refer to the app.



On your mobile device:

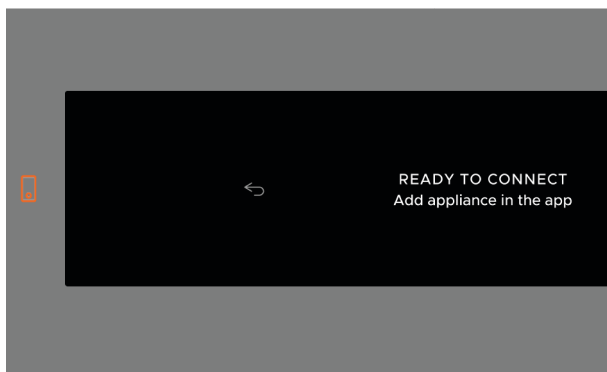

- ① Download the app. Scan the QR code or go to www.fisherpaykel.com/connect
- ② Register and create an account.
- ③ Add your appliance.





Connecting to Wi-Fi

Press and hold **REMOTE**  until **READY TO CONNECT** shows on the display and the Wi-Fi indicator  starts to flash. Follow the instructions in the app to complete the connection.

Once connected, the Wi-Fi indicator  will stop flashing and remain illuminated.



Turning Remote mode on/off

When connected to Wi-Fi, press **REMOTE** , then press **START/PAUSE**  to enable.

When in remote mode, **REMOTE**  will stay illuminated.

CLEAN AND MAINTAIN THE DRYER

Surfaces and accessories

Wipe with a damp cloth and mild detergent, then dry with a clean, lint-free cloth. We do not recommend using the following cleaning products as they may cause damage:

- Plastic or stainless steel scouring pads
- Abrasive, solvent, household cleaners
- Acid or alkaline cleaners
- Hand washing liquids or soap
- Stainless steel cleaners or polishes
- Laundry detergents or disinfectants

Inside the dryer

Check and clean the inside of the drum regularly with a damp cloth to remove any dirt or lint. Do not leave any metal objects in the drum as these may cause rust.

Sensors

The sensors are located behind the lint filter and detect whether the laundry is dry or not. Clean the sensors regularly to maintain drying performance.



Cleaning the sensors

Wipe clean with a soft, damp cloth.

EMPTYING THE WATER TANK

Water collects in the water tank at the top left of the dryer during a drying cycle, unless the drain hose is set up to drain water automatically.

Empty the water tank before or after every load. Never run the dryer without the water tank in place unless the drain hose is installed. Refer to the installation guide for instructions if you want to install the drain hose.



1. Use the handle to pull the water tank out.

The tank can be heavy when full. Support the tank and keep it level to avoid spilling water.



2. Empty the water tank, then place it back in the dryer.

CLEAN THE LINT FILTER

The Lint Filter reminder will pop up at the end of a cycle. Remove and clean the filter each time you use the dryer as blocked filters will reduce drying performance, and lint can become a fire hazard if it builds up in or around your dryer.



1. Open the dryer door and remove the lint filter.



2. Open the filter and separate the parts. Use your hand or a soft cloth to remove the lint from both parts.



3. Refit the internal filter part to the outer part, then close the filter and place it back in the dryer.

CLEAN THE LOWER FILTER

The lower lint filter sits below the lint filter. The Lower Lint Filter and Lint Filter reminders will light up after every 10 cycles to prompt you to remove and clean both filters. Clean them when the reminder comes on or when you notice the drying cycle is taking longer than usual. This will help to maintain drying performance.



1. Remove the lint filter to access the lower lint filter.



2. Remove the lower lint filter, open it and take out the foam.

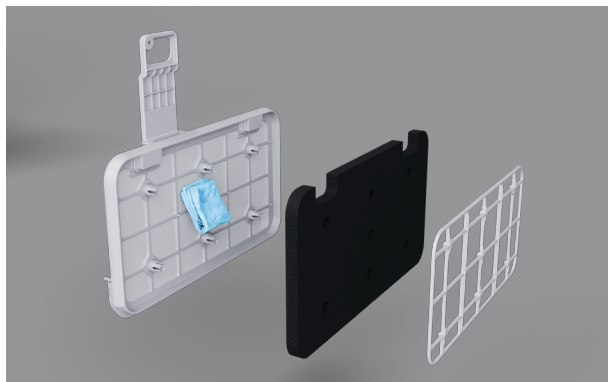



3. Use a cloth or vacuum cleaner to remove lint, then refit the foam to the mesh. Place lower filter back into the dryer, and refit the lint filter.

TROUBLESHOOTING

Why will the dryer not turn on?

No power. Check the dryer is connected to the power supply.

Why is the display not responding?

- Dryer needs to be reset. Press and hold **POWER**  to turn the dryer off. Wait a few seconds, then turn the dryer back on. If the problem persists, disconnect the dryer from the power supply, wait a few seconds, then reconnect and press and hold **POWER**  to turn the dryer on.
 - Dryer may require a software update. Connect dryer to Wi-Fi and check for updates in the app.
-

Why do the items feel damp after a drying cycle?

- Items are just warm and will feel dry once they have cooled down.
 - Incorrect drying settings for the load. Check settings and adjust if required.
-

Why is the drying cycle taking so long?

- Dryer is overloaded. Pause the cycle and remove some items.
 - Items are tangled. Untangle the items and resume the cycle.
 - Lint filters need to be cleaned. Remove and clean the lint filters.
 - Incorrect drying settings for the load. Check the selected fibre type, item type, treatment, method and dryness, and adjust if required.
 - Load was overly wet at the start of the cycle. Remove from dryer and run on a spin cycle in the washing machine to remove excess water.
 - Water tank is full. Empty the water tank.
 - Items are very large. Large items, like duvets, require longer drying times.
 - Dryer is not draining. (Plumbed set-up only.) Check the drain hose for blockages and correct if possible. If the problem persists contact Customer Care.
 - Air intake is blocked. Check that nothing is covering the air intake.
 - Air temperature in the space surrounding the dryer is too hot, humid or cold. The dryer is less efficient in very hot or cold conditions. Ensure the dryer is installed in a well-ventilated space. Do not operate this dryer inside a cupboard.
-

Why is the dryer not starting?

- Dryer door not closed. Check nothing is obstructing the door, and close it firmly.
 - Water tank is full or not correctly in place. Empty the water tank and refit it.
 - Dryer is overloaded. Remove some items and restart the cycle.
 - Delayed start is set. See 'Setting Delayed start'.
 - The controls are locked. Press and hold **KEY LOCK** .
 - There is a fault. See 'Alerts and fault codes'.
-

TROUBLESHOOTING



Why is the Sanitise treatment taking so long?

A Sanitise cycle requires conditions to be met to ensure sanitisation of a load. A number of factors can affect these conditions, i.e. the ambient temperature, how wet or how dry the load is, the temperature of the load, or if the load tangles. If the conditions are not met, a sanitise cycle will run until time out (8 hours) and the load will not be sanitised. The operating conditions for your dryer may be too cold.

Why is the dryer stopping and starting?

The crease free setting is turned on. Press **CREASE FREE** to turn off.

Why did the dryer stop mid-cycle?

- Water tank is full. Empty the water tank.
 - Drying cycle is paused. Press **START/PAUSE**  then press the dial to resume the cycle.
 - Door is open. Close it and press **START/PAUSE**  then press the dial to resume the cycle.
-

Why is the dryer vibrating or making noises?

- Dryer is overloaded. Press **START/PAUSE**  to pause the cycle and remove some items.
 - Dryer is not level. Refer to installation guide for instructions about levelling the dryer.
 - The cycle is close to ending. Prepare to remove items from the dryer.
 - Dryer has a fault. See 'Fault codes'.
-

Why is there lint on the load after a drying cycle?

- The lint filters need to be cleaned. Remove and clean the lint filters.
 - Lint-shedding items are mixed in a load with lint-collecting items. See 'Sort your load'.
 - Clothes are over-dried and attracting lint. Use **AUTO** method to sense when items are at the appropriate dryness level.
-

Why is the fabric damaged after a drying cycle?

- Cycle settings not appropriate for the load type. Follow instructions on care labels and sort items accordingly. See 'Sort your load'.
 - Items removed from dryer before the cycle has finished. Spread items out after removing them from the dryer and allow to cool fully before putting away.
 - Metal parts on the items or in the load may catch on fabric. Always fasten zips and other clasps before placing items in the dryer.
-

TROUBLESHOOTING

Why do items in the dryer keep getting tangled?

- Loads not separated before going in the dryer. Load items individually and try separating larger items from smaller items.
 - Load size is too large. Try drying smaller loads. See 'Sort your load'.
 - Cycle settings not the best option for the load type. Try **SHEETS** for sheets, duvet/doona covers and **TOWELS** for towels.
 - Delicate items not separated. Dry pantyhose, bras and stockings in a mesh bag.
-

Why do items in the dryer keep getting creased?

- Items have been left in the dryer after the cycle ended. Turn **CREASE FREE** on at the start of the cycle to minimise creasing.
 - Dryer is overloaded. Pause the cycle and remove some items.
 - Items not sorted before going in the dryer or dryer settings not appropriate for load.
-

Why is dye transferring onto my clothes?

- Items not sorted before going in the dryer. Separate white and coloured items into separate loads.
 - Wet items left sitting in the dryer before starting the drying cycle.
-

Why is the dryer not draining?

- Water tank is not correctly fitted. Check it is firmly in place.
 - Drain hose or drain is blocked. (Plumbed set-up only.) Check the drain hose and drain for blockages and correct if possible. If the problem persists contact Customer Care.
 - Drain hose not connected correctly. See the installation guide for instructions.
-

Why is the dryer beeping?

- The cycle has ended. Items can be removed.
 - Dryer has a fault. See 'Fault codes'.
-

Why is water coming from under the dryer?

- Water tank is full. Empty the water tank.
 - Water tank is not correctly fitted. Check it is firmly in place.
 - Dryer door not closed. Check nothing is obstructing the door, and close it firmly.
 - Drain hose or drain is blocked. (Plumbed set-up only.) Check the drain hose and drain for blockages and correct if possible. If the problem persists contact Customer Care.
 - Drain hose not connected correctly. See the installation guide for instructions.
-

TROUBLESHOOTING

Why is there water in the dryer drum after a cycle?

- Water tank is full. Empty the water tank.
 - Air temperature in the space surrounding the dryer is too hot, humid or cold, and water may be recondensing in the dryer. Ensure the dryer is installed in a well-ventilated space. Do not operate this dryer inside a cupboard.
-

Can I dry my sneakers in the dryer?

Yes, sneakers can be dried using the drying rack and **RACK DRY**. See 'Fit drying rack'.

How do I refresh my shirts?

Select the relevant fibre type, and set the item type to **DELICATE** and the treatment to **REFRESH**. Only suitable for 1 to 2 items at a time.

Do I need to use the Sanitise cycle on my dryer if I used the Sanitise cycle on my washer?

No. You only need to use the **SANITISE** cycle on one of your products to sanitise a load.

Why is the dryer not heating?

- Water tank is full. Empty the water tank.
 - The cycle is in the cooling phase. This is normal. Wait for the cycle to finish.
 - Dryer has not had a chance to heat. Heat pump dryers take several minutes to start producing heat. For best results, avoid stopping and starting the dryer as this will affect the dryer's ability to operate efficiently.
-

ALERTS AND FAULT CODES

How do I know if there is a problem?

Your dryer will beep and an alert will show in the display. Press the dial to stop the beeping.



How to fix

First try to fix the issue and clear the alert according to the onscreen instructions or the steps in the following table.

ALERT	WHAT TO DO
MAX TIME REACHED	The cycle has reached the 8-hour limit and cannot continue. Press the dial to dismiss the alert.
ROOM TEMP LOW	Wait for the temperature to increase. Press the dial to dismiss the alert.
BLOCKED DRYER FILTERS	Check and clean the lint filters. Press the dial to dismiss the alert.
LOW AIRFLOW DETECTED	Check and clean the lint filters. Press the dial to dismiss the alert.
WATER TANK FULL	Empty the water tank. Press the dial to dismiss the alert.
CYCLE PAUSED	Due to lost power. Press START/PAUSE  then press the dial to resume the cycle.

'E' fault codes

You may be able to clear the fault by resetting the dryer. Follow the steps below:

- ① Press and hold **POWER**  to turn the appliance off.
- ② Wait a few seconds, then press and hold **POWER**  to turn the appliance back on.

If the fault code has disappeared, you can continue to use your dryer.

If the problem persists

- ③ Note down the fault code.
- ④ Contact Customer Care or a Fisher & Paykel trained and supported service technician. Refer to the Service and Warranty booklet for contact details.

COMPLIANCE INFORMATION

Energy label cycle

The energy label cycle, in accordance with AS/NZS 2442.1 and AS/NZS 2442.2 is as follows: Cotton, Item Type: Durable, Dryness: Dry. This cycle is the recommended energy saving cycle for everyday drying, at the rated capacity.

Sanitise

The cycle complies with the microbial reduction requirements of QB/T 5132-2023.

Average elimination rate for the following bacteria, Staphylococcus aureus & Escherichia coli, >99.9%

Certified cycle: COTTON, Item Type: MODERATE, Treatment: SANITISE, Method: AUTO, Dryness: EXTRA DRY.

Load size tested at: DH9060D5 & DH9060DG5 - 2.7kg; DH1060D5 & DH1060DG5 - 3.0kg.

Woolmark Wool Care

The wool drying cycle of this machine has been tested and approved by The Woolmark Company for the drying of machine washable wool products provided that the products are washed and dried according to the instructions on the garment label and those issued by the manufacturer of this machine. M2445.

The maximum capacity of the Woolmark Wool Care cycle is 1kg.

Approved cycle: WOOL, Item Type: DELICATE, Treatment: DRY, Method: TIMED.



MANUFACTURER'S WARRANTY AND SERVICE GUIDE

NZ



To access your Warranty and Service Guide

Scan the QR code with your smartphone to access your warranty and book a service, or view online at <https://www.fisherpaykel.com/nz/help-and-support/warranty-information>

AU



To access your Warranty and Service Guide

Scan the QR code with your smartphone to access your warranty and book a service, refer to your separate warranty and service book or view online at <https://www.fisherpaykel.com/au/help-and-support/warranty-information>

This product has been designed for use in a domestic (residential) environment. This product is not designed for any commercial use. Any commercial use by the customer will affect this product's Manufacturer's Warranty.

Complete and keep for safe reference:

Model _____

Serial No. _____

Purchase Date _____

Purchaser _____

Dealer _____

Suburb _____

Town _____

Country _____

FISHERPAYKEL.COM

© Fisher & Paykel Appliances 2025. All rights reserved.

The models shown in this guide may not be available in all markets
and are subject to change at any time.

The product specifications in this guide apply to the specific products and
models described at the date of issue. Under our policy of continuous product
improvement, these specifications may change at any time.

For current details about model and specification availability in your country,
please go to our website or contact your local Fisher & Paykel dealer.

433287A 10.25