

INSTRUCTIONS FOR USE

BUILT-IN OVEN

EN

OT26BGH
OTP26BGH
OT26SSH.AU
OT26BGH.AU
OTP26SSH.AU
OTP26BGH.AU

Contents

Introduction	3	Save program - save your own settings	27
Safety precautions	4	General settings	28
Safe and correct use of the oven during pyrolytic cleaning	5	Display lock (+ menu)	29
Other important safety warnings	6	Wi-Fi management	30
ConnectLife	8	Managing the oven remote control	30
Appliance description	9	General tips and advice for baking	32
Appliance equipment	9	Cooking table	33
Control panel	11	Cooking with a food probe	39
Before first use	13	Cleaning and maintenance	42
Switching on for the first time	13	Automatic oven cleaning – pyrolysis	42
Calibration with the food probe	14	Cleaning with steam	44
Using the oven – selecting the baking settings	15	Removing wire and fixed pull-out (extendible) guides	45
Main menu - Manual	16	Removing and replacing the oven door and glass panes	46
Timer - Timer functions	19	Replacing the bulb	47
Stage cooking (+ menu)	21	Troubleshooting	48
Auto programs	21	Troubleshooting table	48
Extra	22	Label – appliance information	49
Starting the cooking process	24	Compliance information	50
End of cooking by touching	25	Environment protection	51
Gratin (+ menu)	25	Cooking test	52
Crispy bottom	26		

We thank you for your trust and the purchase of our appliance.

This detailed instruction manual is supplied to make the use of this product easier. The instructions should allow you to learn about your new appliance as quickly as possible.

Make sure you have received an undamaged appliance. If you do find transport damage, please contact the seller from which you purchased the appliance, or the regional warehouse from which it was supplied. The telephone number can be found on the invoice or on the delivery note.

Carefully read the instructions for use before connecting the appliance. Repair or any warranty claim resulting from incorrect connection or use of the appliance shall not be covered by the warranty.



For more detailed instructions and tips scan the QR code on the rating plate.

The following symbols are used throughout the manual and they have the following meanings:

INFORMATION!

Information, advice, tip, or recommendation

WARNING!

Warning – general danger

ConnectLife

Connect your oven to a Wi-Fi network and the ConnectLife app to access all its functions, including advanced features and remote control.

IMPORTANT SAFETY PRECAUTIONS – CAREFULLY READ THE INSTRUCTIONS AND SAVE THEM FOR FUTURE REFERENCE.

The appliance may only be connected to the power mains by an authorized service technician or expert. Tampering with the appliance or nonprofessional repair thereof may result in risk of severe injury or damage to the product.

Appliance must be connected to fixed wiring which has incorporated means of disconnection. Fixed wiring must be made in accordance with the wiring rules.

For the UK market, fixed wiring is required if the device has more than 3 kW. Only the service department should connect the appliance.

For stationary appliances permanently connected to the fixed wiring, compliance with this requirement is deemed to be met if the disconnection instruction incorporated into the fixed wiring complies with AS/NZS 3000 (Australia only).

The appliance must not be installed behind a decorative door in order to avoid overheating.

WARNING: A damaged power cord or connector must only be replaced by the manufacturer, an authorized service technician, or a qualified professional. Improper handling may result in electric shock, fire, or serious injury.

This appliance can be used by children aged 8 years and above, and by persons with reduced physical, sensory or mental capabilities or lack of experience and knowledge, if they have been given supervision or instruction concerning the use of the appliance in a safe way, and if they understand the hazards involved. Children shall not play with the appliance. Cleaning and user maintenance shall not be done by children without supervision.

WARNING: The appliance and its accessible parts become hot during use; avoid contact with heating elements. Children under 8 years of age must be kept away unless continuously supervised.

The appliance is not intended to be controlled by external timers or separate remote control system.

Only use the food probe recommended for use in this oven.

Do not use harsh abrasive cleaners or sharp metal scrapers to clean the oven door glass/ the glass of hinged lids of the hob (as appropriate), since they can scratch the surface, which may result in shattering of the glass.

Do not use steam cleaners or high-pressure cleaners to clean the appliance as this may result in an electric shock.

WARNING: Before replacing the light bulb, make sure the appliance has been disconnected from the mains power, in order to prevent the hazard of an electric shock.

Never pour water directly on the bottom of the oven cavity. Temperature differences could result in damage to the enamel coating.

Safe and correct use of the oven during pyrolytic cleaning

Before activating the automatic cleaning process, remove all equipment from the oven: wire rack, spit-roasting kit, all baking trays, food probe, wire guides, and any other cookware that is not a part of the oven equipment.

Before you start the cleaning process, remove any residue of spilt liquid and all moving parts from the oven cavity.

During the automatic cleaning process, the oven heats up to a very high temperature and it is very hot on the outside as well. Risk of burns! Keep children away from the oven.

Other important safety warnings

The appliance is intended for household use. Do not use it for any other purpose, such as room heating, drying of pets or other animals, paper, fabrics, herbs etc. As this may lead to injury or fire hazard.

The appliance may only be connected to the power mains by an authorized service technician or expert. Tampering with the appliance or nonprofessional repair thereof may result in risk of severe injury or damage to the product.

We recommend that (due to appliance weight) at least two persons carry and install the appliance.

Do not lift the appliance by holding it by the door handle.

Oven door hinges may be damaged when under excessive load. Do not stand or sit on the open oven door, and do not lean against it. Also, do not place any heavy objects onto the oven door.

If the power cords of other appliances located in the vicinity of the oven become entangled in the oven door, they may get damaged, which may cause a short circuit. Therefore, make sure that the power cords of other appliances are at a safe distance.

Make sure the vents are never covered or obstructed in any other way.

Do not line the oven walls with aluminium foil and do not place baking trays or other containers on the bottom of the oven. This would reduce air circulation in the oven, obstruct and slow down the baking process and destroy the enamel coating.

We recommend you avoid opening the oven door during baking, as this increases power consumption and condensate accumulation.

At the end of the baking process, and during baking, be careful when opening the oven door, as there is danger of scalding.

To prevent limescale accumulation, leave the oven door open after baking or using the oven, to allow the oven cavity to cool down to room temperature.

Clean the oven when it has completely cooled down.

Eventual mismatches in colour shades between different appliances or components within a single design line may occur due to various factors, such as different angles under which the appliances are observed, different coloured backgrounds, materials, and room illumination.

Do not use the appliance if it is damaged. Unplug the appliance from the power mains and call an authorized service centre.

The oven can be safely used with or without baking pan guides.

Do not store items in the oven, which could cause danger when the oven is switched on.

Before you activate automatic cleaning, carefully read and observe all instructions in the chapter Cleaning and Maintenance, which describes correct and safe use of this function

Do not place anything on the oven bottom during the automatic cleaning process.

Risk of fire! During automatic cleaning, the appliance is heated to very high temperatures, which will incinerate food residues in the appliance. Therefore, remove visible dirt from the inside of the oven and from the utensils before each use. Smoke, irritating fumes and gases may also come from the oven while the cleaning function is active. Therefore, make sure that the room is well-ventilated while you carry out this procedure. Small animals or pets can be very sensitive to any fumes that might come out from the oven. It is recommended to remove them from the room during operation and to ventilate the room well after cleaning.

Other important safety warnings

Do not open the oven door during cleaning.

Make sure no foreign objects enter the opening for locking the door guide, as this could block automatic door locking during the oven cleaning process.

Do not touch any metal surfaces or parts of the appliance during the automatic cleaning process!

In case of a power outage during the automatic cleaning process, the program will be terminated after two minutes and the oven door will remain locked. The door will be unlocked, when the appliance senses that the temperature has dropped to below 150 °C in the centre of the oven cavity.

After the self-cleaning process, the oven cavity and the oven accessories can discolour and lose their sheen. This does not affect their functionality.

WARNING!

Using the oven with the door open and the door switch closed is not permitted.

WARNING!

Carefully read the instructions for use before connecting the appliance. Repair or any warranty claim resulting from incorrect connection or use of the appliance shall not be covered by the warranty.

Connecting the appliance to the ConnectLife application

ConnectLife is a smart home platform that connects people, devices and services. The **ConnectLife** application includes advanced digital services and carefree solutions that allow users to monitor and control appliances, receive notifications from a smartphone, and update software (supported features may vary depending on your appliance and the region/country in which you are located).

To connect your smart device, you need a home Wi-Fi network (only 2.4 GHz networks are supported) and a smartphone equipped with the application **ConnectLife**.

 **ConnectLife**



To download the **ConnectLife** application, scan the QR code or search for **ConnectLife** in your favourite app store.

1. Install the **ConnectLife** application and create an account.
2. In the **ConnectLife** application, go to the "Add device" menu and select the appropriate type of device. Then scan the QR code (it can be found on the nameplate of the appliance; you can also enter the AUID/MV number manually).
3. The application then guides you through the entire process of connecting the appliance to your smartphone.
4. After a successful connection, the appliance can be operated remotely via the mobile application.

INFORMATION!

If this setting is not available, then your oven is not fitted with a Wi-Fi module and does not support internet connectivity.

When the Wi-Fi module is enabled and connections are successfully set up and synchronized, then the oven can be controlled and operated via a mobile device and the **ConnectLife** app.

The Wi-Fi connection works in the same frequency range as some other devices (e.g. microwave ovens and remote-controlled toys). Consequently, temporary or permanent disruption of the connection is possible. In such cases, the availability of the offered functions cannot be guaranteed.

Ensuring the quality of the functions offered depends heavily on the signal strength. If the router is far away from the appliance, there may be problems with the reliability of the connection.

WARNING!

Appliance functions and equipment depend on the model.

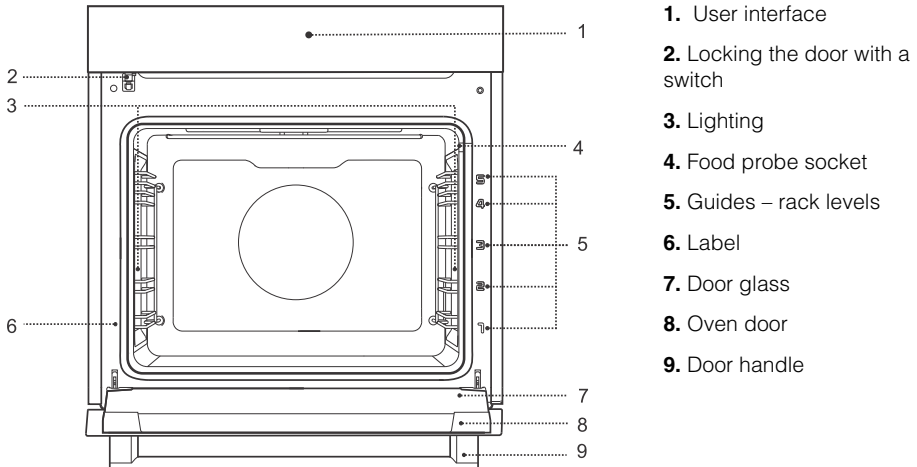

Appliance equipment

(depending on the model)

Oven door switch

The switch switches off the operation of the heaters and the ventilation in the oven room when the oven door is opened during operation.

Guides

Wire guides – always insert the wire rack and baking tray into the guide.

Fixed pull-out guides – place the equipment on the guide. On the same guide, you can place the rack together with the drip pan.

NOTE: Guides – rack levels are counted from the bottom up.

Oven equipment and accessories

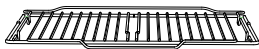

Wire rack – used for grilling/broiling or as support for a pan, baking tray or baking dish.

NOTE: When inserting the wire rack into the guide, always make sure its elevated part is at the back and on the top side.

There is a safety latch on the wire rack. Therefore, the wire rack has to be lifted slightly at the front when pulling it out from the oven.

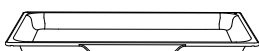

All-purpose baking tray – a versatile baking tray useful for baking pastries, bakery products, cooking vegetables and all types of meat. It can also be used as a drip tray.

Appliance description

Table continued from last page



Food probe - (ΛFOOD PROBE)

It can be used to measure the core temperature of a dish. When the desired temperature is reached, cooking will stop automatically.

Control panel

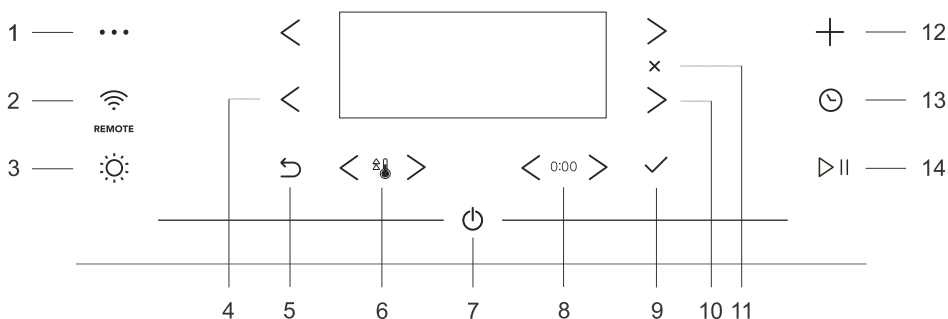

Key		Use
1.	...	Selection of basic menus
2.		Wi-Fi connectivity setting and remote control
3.		Switching the oven light on and off
4.		Left selector key
5.		Exit or return without saving
6.		Switching the fast preheat on and off
7.		Switching the oven on and off
8.	0:00	Time function resets
9.		Confirmation of selection, settings
10.		Right selector key
11.		Cancel the current setting, delete the function
12.		Advanced settings
13.		Selection of time functions
14.		Starting and stopping the operation

NOTE: Only the keys that are enabled in the current menu are illuminated (fully or partially) on the control panel.

Appliance description

Explanation of shortcuts in the manual:



Short press –
for basic selections



Long press, 5 seconds –
for additional settings or fast increase of setting

INFORMATION!

All settings are controlled by the keys.
For better key responsiveness, touch them with a large area of your fingertip. Each time you press a key, this will be acknowledged by an acoustic signal (when this function is available).



First step



Intermediate step



Passed time (exp. oven
is operational)



Optional step

1.	Remove oven utensils and any packaging (cardboard, polystyrene foam, plastic) from the oven.
2.	Wipe the oven accessories and interior with a damp cloth. Do not use abrasive or aggressive cloths or cleaners.
3.	Switch on the oven (see chapter <i>Switching on for the first time</i>).

NOTE: During heating, the characteristic "new smell" is released, so ventilate the room thoroughly during this time.

Switching on for the first time

After connecting the appliance to the mains for the first time or after a prolonged power outage, you will need to set the language and time.

💡 INFORMATION!

If you do not want to set this, touch ✓. The default settings will be saved. You can change the settings at any time (see chapter *General settings*).

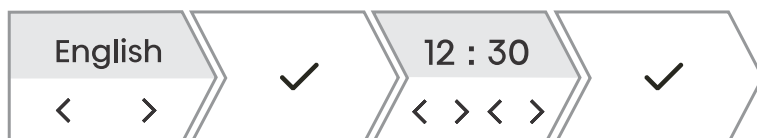

1.	<p>Setting the language:</p> <p>The display shows the default language (English). By pressing < or > you can change the language. Confirm with ✓.</p>
2.	<p>Setting the exact time:</p> <p>By pressing < or > you can set the exact time of day. Set the hours and minutes separately. Confirm your selection with ✓.</p>
3.	<p>Calibration with the food probe</p> <p>The calibration procedure ensures the accuracy of the temperature measurement, as it automatically eliminates any deviations (with a maximum of ± 1 °C). As part of the process, a heating process is also carried out, which removes the residues of the production process and any unpleasant odours through a special heating programme at high temperature. This way, the unpleasant smells will not be transferred to the food prepared in the oven.</p>

All initial settings are set and the appliance is in standby mode.

Before first use

Calibration with the food probe

(depending on the model)

During the calibration process, the food probe allows accurate measurement of the temperature at the centre of the oven (+/-1°C).

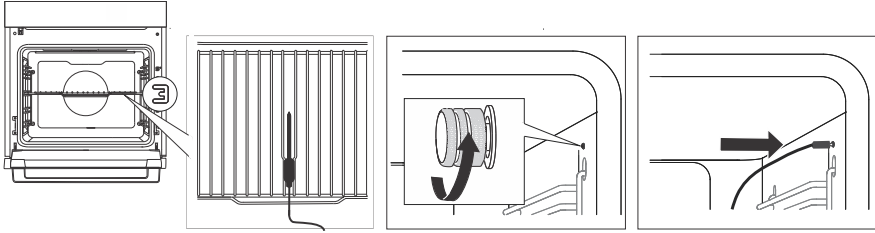

1.	Remove any loose accessories from the oven. Place the wire rack to the third position.
2.	Place the probe in the centre of the rack, with the tip facing the back of the oven.
3.	Unscrew the socket cover (only on some models) on the front in the upper righthand corner of the oven and plug the probe into the socket.
4.	The total calibration process lasts for 4 hours. Do not open the oven door during calibration.
5.	A sound signal is emitted, the calibration is complete. The probe can be switched off and safely put away.

The total calibration time is up to 4 hours. In the event that you decide to skip the procedure, the device will not send further pop-up notifications about performing the procedure. Calibration can be done at any time in the settings menu.

NOTE: During the heating process, unpleasant odours or the characteristic "new smell" may come from the oven. Thoroughly ventilate the room throughout the duration of the programme.

Using the oven – selecting the baking settings

Home menu

Switch on the appliance  and select By pressing < or > you can choose from different menus:

OVEN

Allows you to arbitrarily set the cooking parameters with factory preset values that can be changed (see chapter *Main menu - Manual*).

AUTO PROGRAMS

Allows a large selection of preset programmes depending on the selected dish (see chapter *Auto programs*).

SAVED PROGRAMS

This mode allows you to select your own programmes that you have previously saved (see chapter *Save program - save your own settings*).

EXTRA

Selection of additional programmes (see chapter *Extra*).

CLEANING

Oven cleaning programmes.

SETTINGS

General oven settings (see chapter *General settings*).

+ menu - additional settings

The function provides additional setting options. Menu content varies depending on the control options available at that time.

To select additional settings, touch  .

STAGE COOKING

Three-step cooking setting with different parameters (see chapter *Stage cooking (+ menu)*).

INFORMATION

Detailed information on the programmes and function of the oven systems.

GRATIN

It is used for dishes to which you add dressing/topping or you want to additionally bake its surface at the end. The function can be selected after 10 minutes of cooking or at the end of cooking (see chapter *Gratin (+ menu)*).

SAVE PROGRAM

Saving selected custom settings (see chapter *Save program - save your own settings*).





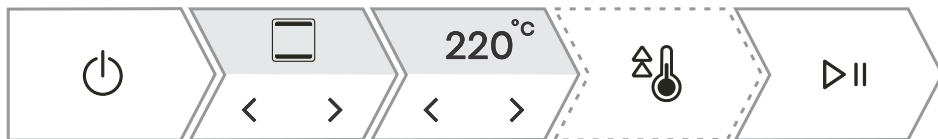

DISPLAY LOCK

Activating / deactivating the safety key lock to protect the oven from accidental use (see chapter *Display lock (+ menu)*).





Using the oven – selecting the baking settings

Main menu - Manual











1.	Switch on the appliance  .
2.	By pressing  or  you can select the cooking system (see table Selection of cooking systems).
3.	By pressing  or  you can set the temperature or power.
4.	Use quick preheating to bring the oven to the desired temperature as quickly as possible. By pressing  the symbol will light up fully. When the set temperature is reached, an acoustic signal sounds. The display will show INSERT THE DISH . Open the door and insert the dish. The programme automatically resumes cooking with the selected settings.
5.	Additionally, you can set: - Timer (see chapter <i>Timer - Timer functions</i>) - Cooking by steps (see chapter <i>Stage cooking (+ menu)</i>)
6.	To start cooking, touch  .

Choosing the baking system

Symbol	Use
	BOTTOM + TOP HEATER Use this system for conventional cooking on a single rack, making soufflés, and cooking at low temperatures (slow cooking). We recommend using preheating, except for dishes that are marked differently in the spreadsheet.
	HOT AIR Hot air allows for better air circulation around the dish. In this way, it dries its surface more and creates a thicker crust. For roasting meat, baking cakes, cooking vegetables and for drying food at one or more levels at the same time.
	HOT AIR + BOTTOM HEATER Perfect for making pizza and pastries with a higher water content. For cooking on one level when you want your dishes cooked and crisp as quickly as possible.
	BOTTOM + TOP HEATER + FAN For even cooking of dishes on one level and making soufflés. We recommend using preheating, except for dishes that are marked differently in the spreadsheet.

Using the oven – selecting the baking settings

Table continued from last page

Symbol	Use
	<p>LARGE GRILL</p> <p>For cooking large quantities of flat foods, such as toasted bread, canapees, grill sausages, steaks, fish, skewers, as well as for gratinating and achieving a nice crispy crust. The heaters mounted on the top of the oven cavity heat the entire surface evenly.</p> <p>Low level - suitable for cooking fish fillets, whole fish, frying cheese. Medium level - suitable for cooking small pieces of meat, fish cutlets, vegetables, canapees, skewers. High level - suitable for cooking steaks, burgers, grill sausages, toast and cooking au gratin.</p>
	<p>LARGE GRILL + FAN</p> <p>For roasting poultry and grilling large pieces of meat.</p>
	<p>MORE SYSTEMS</p> <p>Confirm your selection with ✓ . Additional systems will be displayed.</p>
	<p>LARGE GRILL + BOTTOM HEATER</p> <p>For faster cooking of dishes on one level and for a crispy pastry crust.</p>
	<p>BOTTOM HEATER + GRILL</p> <p>For gentle and controlled slow cooking of delicate food (soft cuts of meat) and baking pastry with a crunchy bottom.</p>
	<p>BOTTOM HEATER + GRILL + FAN</p> <p>For optimal preparation of yeast-leavened bakery products and all types of bread and for preservation.</p>
	<p>LARGE GRILL + BOTTOM HEATER + HOT AIR</p> <p>For dishes where even crispiness from all sides is desirable. The function is also suitable as a first step of multi-step roasting of meat, as it allows for quick searing of the surface in the initial phase and slow roasting in the second phase. The meat will be juicy and the crust nicely browned.</p>
	<p>AIR FRY</p> <p>This cooking method gives the food a crispy crust, without added fat. It is a healthy version of "fast food" with a lower calorie content. Suitable for small cuts of meat, fish, vegetables and pre-cooked frozen products (French fries, chicken medallions, etc.). For best results, we recommend placing your food in a cold oven. If the oven is preheated, set the temperature up to 20 °C higher than indicated on the food packaging.</p>
	<p>ECO HOT AIR ¹⁾</p> <p>For gentle, slow and even cooking of meat, fish and pastries on one level. This way of cooking retains a higher proportion of water in the meat, which leaves it juicier and softer, while the pastry becomes evenly browned/baked. The used temperature range is between 140 °C and 220 °C.</p>

Using the oven – selecting the baking settings



Table continued from last page

Symbol	Use
	AUTO PROGRAMS Shortcut to the Auto menu (see chapter Auto menu)

¹⁾ This function is used to determine the energy efficiency class according to EN 60350-1.

Using the oven – selecting the baking settings

Timer - Timer functions

To select the timer functions, touch  . By touching the buttons  or  you can select the time function you want to set.

INFORMATION!

The clock must be set to day time.





INFORMATION!

You can reset the selected time function by touching **0:00** .

Description / time function	Use
DURATION	In this mode, you can specify the duration of operation for the oven.
EGG TIMER	The independent alarm operates independently of the oven operation. After the set time has expired, the appliance does not turn on or off automatically.
END BAKING AT	Use this mode when you want the food in the oven to start cooking with a time delay. Enter the duration and desired end time of cooking. The appliance starts automatically and ends its operation at the desired time.

Setting duration



1. By pressing  or  you can set the desired cooking time (hours and minutes). Confirm your selection with  . The oven operating time selected will appear on the display unit.
2. To start cooking, touch  .

Setting the timer



Using the oven – selecting the baking settings

1. By pressing < or > you can set the duration of the independent alarm (hours and minutes). Confirm your selection with ✓.

The maximum possible setting is 24 hours.

NOTE: If the appliance is switched off, the alarm will still be active.

End of cooking setting



1. First set the cooking time. With the key < or > you can set the desired cooking time (hours and minutes). Confirm your selection with ✓. The oven operating time selected will appear on the display unit.
Example: cooking time is 2 hours
2. You can select the delayed operation by pressing ⌚ and then double-clicking on >. By pressing < or > you can set the time at which you want the dish to be ready. Confirm your selection with ✓. The desired end time is shown on the display.
Example: cooking ends at 18:00 ⌚
3. To start cooking, touch ▷||.
The oven switches to partial standby mode while waiting for switch-on. The selected settings are automatically switched on and off at the selected time.
Example: cooking starts at 16:00, cooking ends at 18:00

After the set time has expired, the oven stops working automatically. A short beep will be emitted.

⚠ WARNING!

This function is not suitable for food that requires quick preheating. Perishable food should not be kept in the oven for a long time. Before using this mode, check whether the clock on the appliance is accurately set.

Using the oven – selecting the baking settings

Stage cooking (+ menu)

This function allows you to set the cooking in three steps (combine three consecutive cooking steps in one cooking process).

⚡ INFORMATION!

The function can be set in the Main Menu - manual cooking mode (see chapter *Main menu - Manual*).

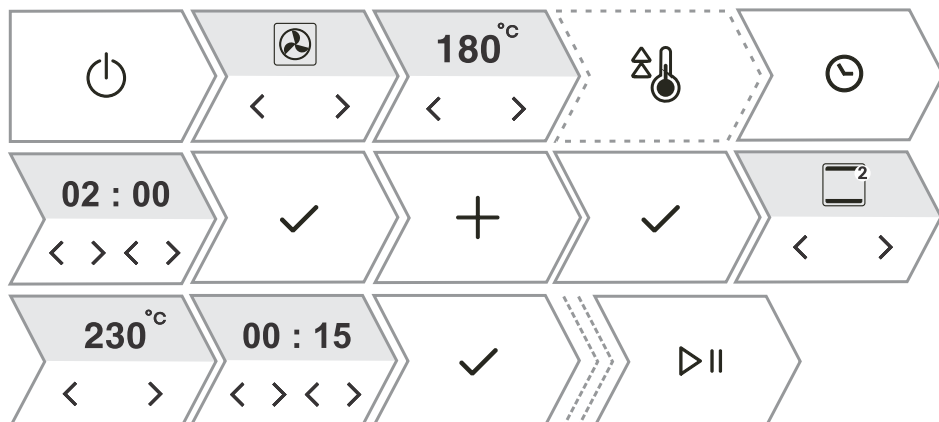

1.	Switch on the appliance .
2.	STAGE 1 By pressing or you can select the cooking system, temperature and cooking duration as the first step. You can also choose quick preheating.
3.	Select additional settings. Press . The display shows ADD STAGE? . Confirm with .
4.	STAGE 2 Select the settings for the second cooking step (see setting under point 2) and touch . NOTE: Do the same for STAGE 3 .
5.	You can also change all three steps before starting cooking. By pressing or you can select the step you want to change.
6.	To start cooking, touch . The oven first starts working with the settings for the first step.
NOTE: You can remove an individual step by touching .	

Auto programs

The programme offers you a large selection of preset recipes that were approved by chefs and nutritionists.

Using the oven – selecting the baking settings

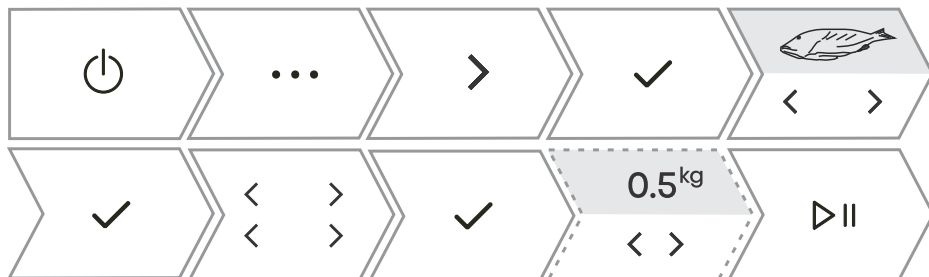

1. Switch on the appliance and select By touching < or > select **AUTO PROGRAMS**. Confirm with ✓ to enter the submenu.
2. By touching < or > you select the type of food and then the selected dish. Confirm with ✓ .
The recipes have a predetermined system, temperature and cooking time.
NOTE: For some dishes, you can change the weight and degree of cooking.
3. To start cooking, touch ▷|| .
4. Some dishes also include the quick preheating function. When the set temperature is reached, an acoustic signal will sound. The display will show **Insert dish**. Open the door and insert the dish. The programme automatically resumes cooking with the selected settings.

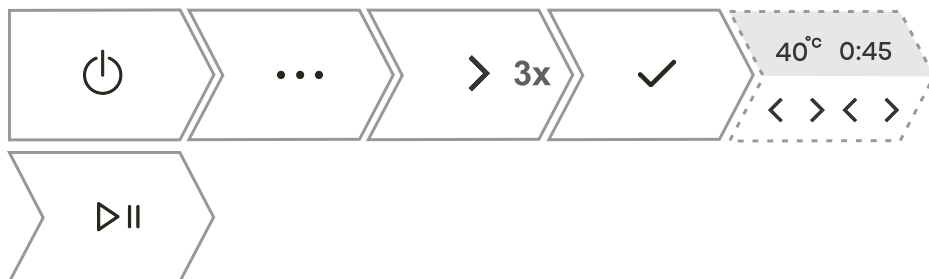

NOTE: By touching + you can see a detailed description of the current selection.

Extra



1. Switch on the appliance and select By touching < or > select **EXTRA**. Confirm with ✓ to enter the submenu.
2. By touching < or > you select the function (see table below). Confirm with ✓ .
Preset values are displayed. Some functions allow you to set the temperature and cooking duration.
3. To start cooking, touch ▷|| .

Using the oven – selecting the baking settings

Programme	Use
AIR FRY	<p>Frying food with hot air, without added fat. Faster and healthier version of "fast food". This cooking method gives the food a crispy crust, without added fat. It is a healthy version of "fast food" with a lower calorie content.</p> <p>NOTE: For optimal results, use an Airfry grid tray, which allows hot air to circulate evenly around the food.</p> <p>Frying food with hot air, without added fat. Faster and healthier version of "fast food". This cooking method gives the food a crispy crust, without added fat. It is a healthy version of "fast food" with a lower calorie content.</p>
PROOFING	The dough will rise faster and more evenly without drying out the surface. While the dough is rising, do not open the door.
DEHYDRATE	With the help of air, you reduce the amount of moisture in the food and thus prolong its durability.
DEFROST	<p>It is used for slow defrosting of frozen food (cakes, pastries, breads and rolls and deep-frozen fruit).</p> <p>Halfway through the defrosting time, turn the food pieces over and separate them if they have been frozen on top of each other.</p>
REHEAT	This mode allows you to gently reheat ready-made dishes. Do not open the door unnecessarily during operation.
KEEP WARM	It is used to keep already prepared dishes warm. Do not open the door during operation.
PLATE WARMING	Useful if you want to preheat the plates or cups so that the food stays warm for a long time. You can set the temperature.
PRESERVING	The process by which we prolong the durability of the food. Use jars with a rubber sealing ring and lid. Do not use jars with threaded or metal caps or metal tins. Pour 1 litre of hot water (approximately 70 °C) into the deep tray and place 6 identical jars into the tray. Place the baking tray in the oven on the second guide.
STERILISE BOTTLES	Suitable for sterilisation of all types of bottles. Sterilisation is a process that destroys all types of microorganisms.
SABBATH	<p>The Sabbath function allows the food in the oven to stay warm without having to turn the oven on and off.</p> <p>Set the duration of operation (between 24 and 72 hours) and temperature. By pressing  , the countdown begins.</p> <p>All sounds and operations are switched off except for the key  .</p> <p>NOTE: In case of a power outage, Sabbath mode will be deactivated and the oven will return to its initial state.</p>

Starting the cooking process

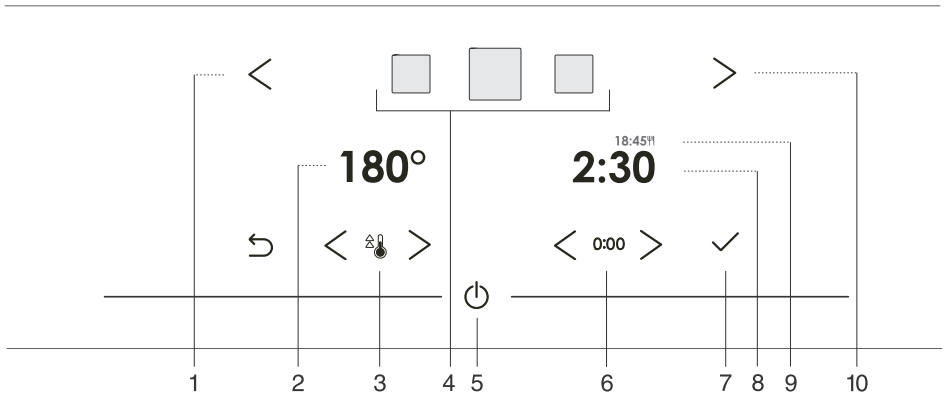

Key	Use
1.	Left selector key
2.	180° Selecting the temperature
3.	Switching the fast preheat on and off
4.	Selected cooking system
5.	Switching the oven on and off
6.	0:00 Time function resets
7.	Confirmation of selection, settings
8.	2:30 Elapsed cooking time
9.	18:45 End time
10.	Right selector key

NOTE: Only the keys that are enabled in the current menu are illuminated (fully or partially) on the control panel.

During the cooking process, you can change the system, temperature and timer functions.

End of cooking by touching

After cooking is completed, the display shows **BAKING FINISHED**.
You can also stop the operation by touching **BAKING FINISHED**.

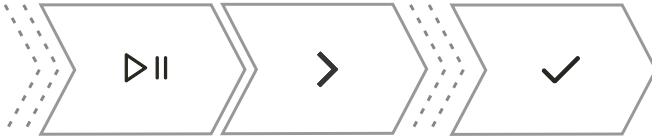

By pressing < or > you can choose a new setting. Confirm with ✓ .
Menu content varies depending on the control options available at that time.

FINISH	Select End to finish cooking. The main menu appears on the display.
CONTINUE BAKING?	By selecting this, you extend the cooking with the same system and temperature settings. NOTE: If you had a cooking duration set, the time is counted forward from where it was stopped.
GRATIN	Select to cook the top of the dish even more (see chapter <i>Gratin (+ menu)</i>).
CRISPY BOTTOM	Select to further brown the underside of the dish (see chapter <i>Crispy bottom</i>).
ADD TO SAVED PROGRAMS?	This mode allows you to save the selected settings to your favourites and use them again later (<i>Save program - save your own settings</i>).

INFORMATION!

After the operation is completed, all timer settings are also stopped and deleted, except for the egg timer. Time of day (clock) will be displayed. The cooling fan will continue to operate for a while.

After the use of the oven, some water may be left in the condensate channel (underneath the door). Wipe the channel with a sponge or a cloth.

Gratin (+ menu)

This function is used in the last phase of cooking, when we add dressing/topping to the dish or we want to crispen its surface. When using the gratin function, a crispy golden yellow crust is formed on the dish, which protects it from drying, and at the same time gives the dish a nicer appearance and better taste.

End of cooking by touching

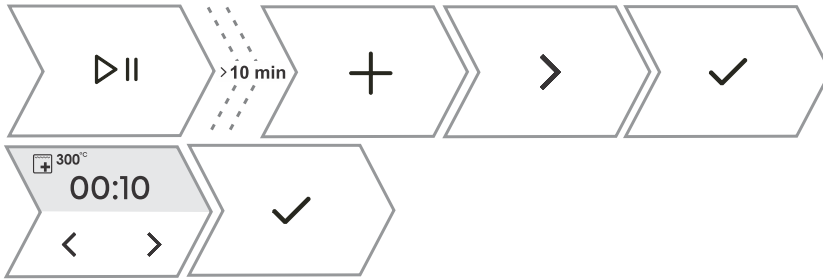

1. Touch **+** and press **<** or **>** to select **GRATIN**. The function is available after 10 minutes of operation.
2. The display shows the preset system (large grill) and the temperature 300 °C. Set the operating time (max 10 min) and confirm the selection by touching **▷||**.
3. The function can also be switched off during operation. Switch off the cooking by touching **▷||**.

⚠ WARNING!

Control the cooking. When using the au gratin function, the oven reaches high temperatures.
The au gratin function works for a maximum of 10 minutes, then the oven switches off automatically.

Crispy bottom



This function is available only at the end of cooking and can be activated for 10 min.

1. In the closing menu, press **<** or **>** to select **CRISPY BOTTOM**. Confirm your selection by tapping **▷||**.
2. Switch off the cooking by touching **▷||**.

Save program - save your own settings

Save program is a feature that allows you to save your favourite and most frequently used settings and use them again in the future. Up to 12 recipes can be stored.



1.	<p>Saving recipes in settings. Touch + and press < or > to select ADD TO SAVED PROGRAMS? Confirm with ✓.</p>
2.	<p>Saving the setting after cooking is completed. In the closing menu, press < or > to select ADD TO SAVED PROGRAMS? Confirm with ✓.</p>
<p>You can also change the name of a saved setting. By pressing < or > you select the letter and confirm it with ✓. If necessary, delete the character with X. Confirm with + to save your favorite recipe.</p>	
3.	<p>Displaying already saved recipes. Touch Press < or > to select SAVE PROGRAM. Confirm with ✓ to enter the submenu. Saved recipes are displayed. NOTE: You can also change the preset values for already saved recipes and save them under a new name after cooking.</p>
4.	<p>Deleting already saved recipes Switch on the appliance and select By touching < or > select SAVE PROGRAM. Confirm with ✓ to display saved recipes. Select a recipe and delete it by tapping X.</p>

General settings

WARNING!

After a power outage or after the appliance is switched off, additional function settings will remain stored for no more than a few minutes. Then, all settings, except for the acoustic signal volume and display dimmer will be reset to factory defaults.



Touch Press < or > to select **SETTINGS**. Confirm with ✓ to enter the submenu.
You can edit individual settings with the key < or > .





1.		TIME Set the hours and minutes. You can select the 12h or 24h display by touching ⌚ .
2.		VOLUME You can choose between four levels of volume (no sound, low, medium, high).
3.		TOUCH SOUND Enable or disable key sound.
4.		NIGHT MODE This feature automatically reduces display brightness between 19:00 and 7:00 and turns off the clock display as well as the acoustic signals. To activate night mode, specify the start time and end time of operation. Turn off the night mode by pressing ⌚ .
5.		DISPLAY The function allows you to turn the daytime display on or off. It is deactivated by default (OFF). If the function is turned on (ON), electricity consumption may increase.
6.		FAST PREHEAT SETTINGS The function activates automatic preheating to cooking systems that allow it. Turn it on (ON) or off (OFF).

Table continued from last page

7.	 <p>A toggle switch with 'OFF' on the left and 'ON' on the right. The switch is currently in the 'ON' position. Below the switch are left and right arrow icons.</p>	<p>HEATING SYSTEMS The function activates the display of all cooking systems on the display unit. Choose to turn on (ON) or off (OFF).</p>
8.	 <p>A screen with 'RESET?' at the top and a checkmark icon at the bottom.</p>	<p>RESET SETTINGS TO FACTORY The function resets the appliance to factory settings. The display shows Reset, which is confirmed by long pressing .</p>
9.	 <p>A screen with 'ENGLISH' at the top and left and right arrow icons at the bottom.</p>	<p>LANGUAGE The display shows the default language (English). If the language in which the texts are displayed on the display does not suit you, choose another one.</p>
<p>To exit the general settings menu, touch ... or .</p>		

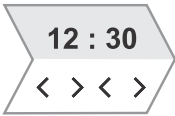
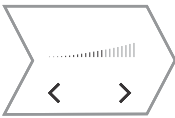
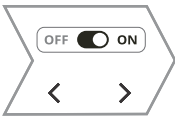
Display lock (+ menu)

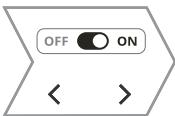
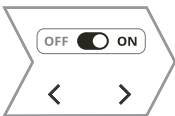
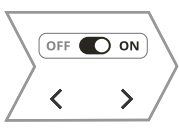
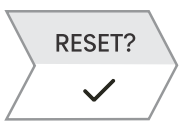
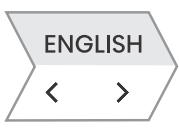
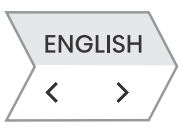



1.	<p>Touch + and press < or > to select DISPLAY LOCK. Confirm the selection by touching . The screen is now locked. To unlock the screen, touch + again and confirm your selection by long pressing .</p>
----	--















- If the lock is activated with no timer function engaged (only clock is displayed), then the oven will not operate.
- If the lock is activated after a timer function has been set, then the oven will operate normally; however, it will not be possible to change the settings.
- When the keys are locked, you cannot change the cooking systems or additional functions. You can only turn off the cooking.
- The keys remain locked even after the oven is switched off. To select a new system, you must deactivate the lock.

Wi-Fi management

Switch on the appliance .

To enter the Wi-Fi module function setting, touch .

If you have pressed  inadvertently, you can cancel the setting by holding (for 18 seconds) .

1.	 < 3 s 	Switching on the Wi-Fi module: After long-pressing (up to 3 seconds)  , the display will show WIFI ON to indicate that the module is switched on. The symbol WIFI ON will start blinking.
2.	 > 3 s < 6 s 	Connecting the appliance: After long-pressing (between 3 to 6 seconds)  , the display will show CONNECTION SETUP . NOTE: For further settings, follow the instructions in the ConnectLife app..
3.	 > 6 s < 9 s 	Connecting additional users: After long-pressing (between 6 to 9 seconds)  , the display will show PAIRING . Use this setting to connect additional users to the appliance using the ConnectLife app.. NOTE: For further settings, follow the instructions in the ConnectLife app..
4.	 > 9 s < 12 s 	Removing all connected users: After long-pressing (between 9 and 12 seconds)  , the display will show UNPAIR ALL . Use this setting to remove all connected users from the ConnectLife app..
5.	 > 15 s < 18 s 	Switching off the Wi-Fi module: Switch off the Wi-Fi connection by long tapping (between 15 and 18 seconds)  . The display will show WIFI OFF .

Managing the oven remote control

WARNING!

The remote monitoring function via a mobile device should not be used to replace direct personal supervision of the cooking process in the oven. Always regularly check, in person, what is actually going on in the oven.

Touch . The display shows **Remote**, indicating the possibility of remote control via the ConnectLife app.

INFORMATION!

For safety reasons, some functions are not available via remote access.

- If the oven is in standby mode and you open the oven door, the remote control option has to be enabled again.
- If oven door is opened during the baking process, the remote control option on the oven is disabled.
- Any user activity on the control unit will automatically disable the remote control option on the oven.
- Cancellation or completion of the baking program or process is the only option that remains available regardless of whether remote control is enabled or not.
- Remote control is disabled when using a microwave system (not applicable to combined microwave systems).

WARNING!

Always make sure the oven is used correctly and in compliance with the instructions, especially when using remote control. Do not run the oven via remote access unless you are certain about what exactly is in the oven.

Wi-Fi status	Wi-Fi symbol on the display unit
Wi-Fi is disabled.	Wi-Fi is constantly dimly lit.
Wi-Fi is enabled and it is successfully connected to the server.	The Wi-Fi symbol is constantly fully lit.
Wi-Fi is enabled and: <ul style="list-style-type: none"> • a connection to the server is being established, • is in the state of setting up or establishing connections, • there is no connection to the server. 	Wi-Fi icon is fully lit and flashes.
Remote control of the oven is not enabled.	REMOTE symbol is not lit on the display unit.
Remote control of the oven is enabled.	REMOTE sign is fully lit on the display unit.

General tips and advice for baking

Equipment:

- Use equipment made of heat-resistant non-reflective materials (supplied baking trays and dishes, enamel-coated cookware, tempered glass cookware). Bright-coloured materials (stainless steel or aluminium) materials reflect heat. As a result, thermal processing of food in them is less effective.
- Always insert the baking sheets and trays to the end of the guides. When baking on the wire rack, place the baking dishes or trays in the middle of the rack.
- Do not place baking trays, food, or other items on the bottom of the oven. Such use may cause permanent damage to the interior surface of the oven and negatively affect the safety and efficiency of the appliance.
- Do not cover the oven cavity bottom or the wire rack with aluminium foil.
- Always place the baking dishes onto the wire rack.
- If you are using parchment paper, make sure it is resistant to high-temperatures. Always trim it accordingly. Parchment paper prevents the food from sticking to the baking tray and makes it easier to remove the food from the baking tray.
- When cooking directly on the wire rack, insert the all-purpose baking tray one level lower to serve as a drip tray.

Food preparation:

- For optimum food preparation, we recommend observing the guidelines specified in the cooking table. Choose the lower specified temperature and the shortest specified cooking time. When this time expires, check the results and then adjust the settings as necessary.
- When cooking according to recipes from older cookbooks, use the bottom and top heater system (as in conventional ovens) and set the temperature 10 °C lower than specified in the recipe.
- When cooking larger cuts of meat or pastry with higher water content, a lot of steam will be generated inside the oven, which in turn may condense on the oven door. This is a normal phenomenon which will not affect the operation of the appliance. After the cooking process, wipe the door and the door glass dry.

Efficient use of energy











- Preheat the oven only if indicated in the recipe or in the tables in this instruction manual. If you are using quick preheating, do not put food in the oven until the oven is fully heated, unless otherwise recommended. When heating an empty oven, a lot of energy is consumed, so if possible, we recommend that you prepare several dishes in a row or several dishes at the same time.
- Remove all unnecessary equipment from the oven during baking
- Unless it is absolutely necessary, do not open the oven door during baking.
- With longer cooking programs, you can switch off the oven approximately 10 minutes before the end of cooking time to make use of the accumulated heat.

General tips and advice for baking

Cooking table















NOTE: Dishes marked in the table:

- one star * , stir repeatedly and turn, two stars ** , preheat the oven. In this case, do not use the quick preheat mode.

Dish	 cm			 °C	 min
PASTRY AND BAKERY PRODUCTS					
pastry/cakes in moulds					
sponge cake	60	3	—	160-170	30-40
	45	1			
pie with filling	60	2	—	170-180	60-80
	45	1			
marble cake	60/45	2	—	180-190	50-70
cake with leavened dough, Gugelhupf (Bundt cake, pound cake)	60/45	1	—	170-180	50-60
open pie, tart	60	3		170-180	35-45
	45	2			
brownies	60	2		170-180	35-45
	45				30-40
pastry on baking trays and dishes					
strudel	60/45	2		170-180	50-60
strudel, frozen	60/45	2		200-210	80-100
sponge roll	60	3		160-170	30-40
	45	1			—
buchteln	60/45	2	—	180-190	30-40
biscuits, cookies					
cupcakes	60	3	—	140-150**	25-35
	45	2			
yeast-leavened small pastry	60	3	—	170-180	20-30
	45	2			













General tips and advice for baking

Table continued from last page

Dish	 cm			 °C	 min
yeast-leavened small pastry, 2 levels	60	2+4		160-170	20-30
	45	1+3		160-170	30-40
puff pastry	60	3	—	190-200	10-20
	45	1	—		
puff pastry, 2 levels	60	2+4		160-170**	15-25
	45	1+3			10-20
cookies/biscuits					
piped cookies	60	3		140-150**	20-30
	45	2			25-35
cookies/biscuits	60	3		160-170**	15-25
	45				
biscuits, 2 levels	60	2+4		160-170**	15-25
	45	1+3			
meringue	60	2	—	80	110-130
	45				
meringue, 2 levels	60	2+4		100**	110-130
	45	1+3			
macarons	60	3	—	140	10
	45	2		130	15-20
bread					
rising and proofing	60	2		30	30-60
	45	1			
bread on a baking tray	60	1	—	220 **	15
				190	25-40
	45	2		220 **	15
				190	25-40
bread in a tin	60	1		190-200	30-45
	45			200 **	40-50
flatbread (focaccia)	60/45	2	—	220 **	20
				180	5-15









General tips and advice for baking

Table continued from last page

Dish	 cm			°C	⌚ min
fresh bread rolls (Semmel/morning rolls)	60	3	—	200-210 **	15-25
	45	2			
fresh bread rolls (Semmel/morning rolls), 2 levels	60	2+4		200-210 **	20-30
	45	1+3			15-25
toast	60	5		L3	5-15
	45	4			
open sandwiches	60/45	4		L2	3-10
pizza and other dishes					
homemade pizza	60	1		max **	4-12
	45				
homemade pizza, 2 rack levels	60	2+4		max	15-25
	45	1+3			20-30
frozen pizza	60	2		210-220	15-20
	45				15-25
frozen pizza, 2 levels	60	2+4		210-220	15-25
	45	1+3			
savoury pie, quiche	60/45	2		190-210	50-60
burek	60	1	—	200-210	40-50
	45				35-45
MEAT					
beef and veal					
beef roast (loin, rump), 1.5 kg	60/45	2	—	160-170	160-190
sirloin, medium done, 1 kg	60/45	2	—	180-190	35-45
beef roast, slow cooked	60	2	—	100-120	150-240
	45	1			
beef steaks, well done, 3 cm thickness	60/45	3		L3	20-30
burgers, thickness 3 cm	60	4		L4	30-40
	45	3			

















General tips and advice for baking

Table continued from last page

Dish	 cm			°C	⌚ min
veal roast, 1.5 kg	60	2	—	190-200	90-110
	45	1			
pork					
pork roast, rump, 1.5 kg	60	3	—	190-200	70-100
	45	2			85-100
pork roast, shoulder, 1.5 kg	60	2		180-190	90-110
	45	1			
pork loin, 400 g, slow cooked	60	2	—	100-120	200-300
	45				250-350
pork roast, slow cooked	60	2	—	100-120	150-240
	45	1			
pork ribs, slow cooked	60	3	—	120-140	210-310
	45	2			
pork chops, thickness 3 cm	60	4		220-230	25-35
	45	3			
poultry					
poultry, 1.2–2.0 kg	60/45	2		210-220	50-70
poultry with stuffing, 1.5 kg	60	2		170-180	70-90
	45	1			
poultry, breast	60	3		170-180	60-90
	45	2			
chicken thighs	60	3		210-220	35-45
	45	2			
chicken wings	60	3		210-220	35-45
	45	2			
poultry, breast, slow cooked	60	3	—	100-120	40-80
	45	2			
meat dishes					
meat loaf, 1 kg	60	2		170-180	60-70
	45				50-60















General tips and advice for baking

Table continued from last page

Dish	 cm			°C	⌚ min
grill sausages, bratwurst	60	4		L2	30-40*
	45	3			20-30*
FISH AND SEAFOOD					
whole fish, 350 g	60	4		200-220**	20-30*
	45	3			
fish fillet, thickness 1 cm	60	4		210-220	5-15
	45	3			
fish steak, thickness 2cm	60	4		160-170	15-25
	45	3			
scallops	60	4		220-230 **	5-15
	45	3			
shrimps	60	4		L2	20-30
	45	4			15-25
VEGETABLES					
baked potatoes, wedges	60	3		190-210	40-50*
	45	2			
baked potatoes, halved	60	3		200-220	30-40*
	45	2			
stuffed potato (jacket potato)	60/45	2		200-210	25-35
French fries, home-made	60	3		210-220	25-35*
	45	2			
mixed vegetables, wedges	60	4		200-210	10-20*
	45	2			15-25*
stuffed vegetables	60/45	2		200-210	40-50
CONVENTIONAL PRODUCTS – FROZEN					
French fries	60/45	2		200-210	30-40*
french fries, 2 levels	60	2+4		200-210	30-40*
	45	1+3			40-50*

General tips and advice for baking

Table continued from last page

Dish	 cm			°C	⌚ min
chicken medallions	60	3		210-220	25-35*
	45	2			20-30*
fish fingers	60	3		210-220	25-35*
	45	2			20-30*
lasagne, 400 g	60/45	2		210-220**	40-50
diced vegetables	60/45	2		190-200	35-45*
croissants	60	3		100	20
				170	15-20
	45	1		100	20
				170	15-20
BAKED PUDDINGS, SOUFFLÉS AND DISHES AU GRATIN					
potato moussaka	60/45	2		180-190	35-45
lasagne	60/45	2		180-190	35-45
sweet baked pudding	60	2		170-180	40-50
	45				35-45
sweet soufflé	60	3	—	180 **	16-20
	45	2			
dishes au gratin	60	3		170-190	30-45
	45	2			
stuffed tortillas, enchiladas	60/45	2		180-190	10-20
grilling cheese	60	4		L1	15-25*
	45	3			10-15*

General tips and advice for baking

Cooking with a food probe (📏FOOD PROBE)

(depending on the model)

The food probe allows for accurate monitoring of the core temperature of food during cooking.

⚠️ WARNING!

The food probe should not be in direct vicinity of the heating elements.

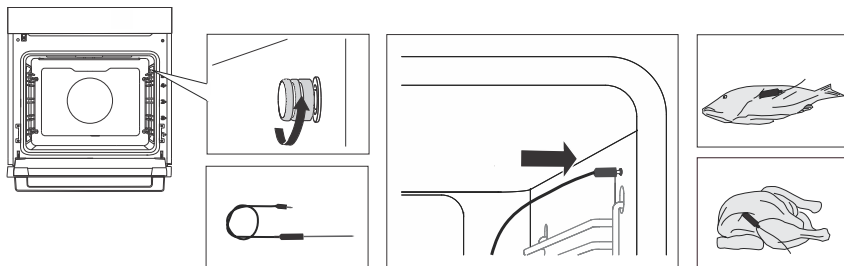

1. Stick the metal end of the probe into the thickest part of the food.
NOTE: To start cooking with the food probe, the current cooking process must first be interrupted and then the food probe must be connected to the socket. By inserting the probe into the socket, the preset functions on the oven are deleted.
2. Unscrew the socket cover in the upper righthand corner of the front of the oven (depending on the appliance model) and plug the probe into the socket.
By pressing < or > select automatic or manual setting.
3. - In manual mode, the symbol 📏 will appear next to the system on the display unit, together with the preset cooking temperature (in the temperature range up to 210 °C), which can be changed. Also determine the core temperature of the food (in the temperature range from 30 to 99 °C). The use of manual mode is shown in the picture above.
- In automatic mode, touch < or > to select the dish. The recipes have a predetermined system, temperature and cooking time. You can change the degree of browning
NOTE: When using the probe, setting the cooking time is not possible.
4. Confirm the setting by touching ▷|| .
During cooking, the set temperature and current temperature of the foodstuff are alternated on the display. If desired, you can change the cooking temperature or the desired core temperature of the foodstuff during operation.
5. When the set core temperature is reached, the oven will stop operating. The display will show **Cooking complete**. An acoustic signal will be heard which you may turn off with any key. After one minute, the acoustic signal will be switched off automatically.

💡 INFORMATION!

The use of a food probe enables automatic cooking selection mode.

General tips and advice for baking













Correct use of the probe, by type of food:

- poultry: stick the probe in the thickest part of the breast;
- red meat: stick the probe into a lean part that is not marbled with fat;
- smaller chunks with bone: stick them into an area along the bone;
- fish: stick the probe behind the head, towards the spine.

WARNING!







After use, carefully remove the probe from the food and socket, clean it, and tighten the socket cover.

Recommended doneness levels for different types of meat

Type of food	 / $^{\circ}\text{C}$ / 	medium rare [$^{\circ}\text{C}$]	medium [$^{\circ}\text{C}$]	medium well [$^{\circ}\text{C}$]	well done [$^{\circ}\text{C}$]
BEEF					
beef, roast	 / 170 / 2	48-52	53-58	59-65	68-73
beef, sirloin	 / 140 / 2	49-53	54-57	58-62	63-66
roast beef/rump steak	 / 160 / 3	49-53	54-57	58-62	63-66
burgers	 / High / 4	54-57	60-63	66-68	71-74
VEAL					
veal, sirloin	 / 140 / 2	49-53	54-57	58-62	63-66
veal, rump	 / 160 / 2	49-53	54-57	58-62	63-66
PORK					
roast, neck	 / 170 / 3	/	/	65-70	75-85
pork, loin	 / 140 / 2	/	/	60-69	/
meat loaf	 / 170 / 2	/	/	/	80-85
LAMB					
lamb	 / 170 / 3	60-65	66-71	72-76	77-80
MUTTON					
mutton	 / 170 / 3	60-65	66-71	72-76	77-80

General tips and advice for baking

Table continued from last page

Type of food	 / $^{\circ}\text{C}$ / 	medium rare [$^{\circ}\text{C}$]	medium [$^{\circ}\text{C}$]	medium well [$^{\circ}\text{C}$]	well done [$^{\circ}\text{C}$]
GOAT MEAT					
goat	— / 170 / 3	60-65	66-71	72-76	77-80
POULTRY					
poultry, whole	 / 210 / 2	/	/	/	82-90
poultry, breast	 / 170 / 2	/	/	/	62-65
FISH AND SEAFOOD					
trout	 / 210 / 4	/	/	62-65	/
tuna	 / Medium / 4	/	/	55-60	/
salmon	 / Medium / 4	/	/	52-55	/

Cleaning and maintenance

WARNING!

Be sure to unplug the appliance from the power supply and wait for the appliance to cool down.

Children should not clean the appliance or perform maintenance tasks without proper supervision.

- For easier cleaning, oven cavity and baking tray are coated with special enamel for a smooth and resistant surface.
- Regularly clean the appliance and use warm water and hand dishwashing liquid to remove larger impurities and limescale. Use a clean soft cloth or sponge cloth.
- Never use aggressive or abrasive cleaners and accessories (abrasive sponges and detergents, stain and rust removers, scrapers for glass ceramic plates).
- Food residue (fat, sugar, protein) can ignite during the use of the appliance. Therefore, remove larger chunks of dirt from the oven interior and accessories before each use.
- Oven equipment is dishwasher-safe. Pull-out guides are not suitable for this type of cleaning.

Exterior of the appliance	Use hot soapy water and a soft cloth to remove impurities and wipe the surfaces dry.
Interior of the appliance	For stubborn dirt or grime, use conventional oven cleaners. After using such agents, wipe the appliance thoroughly with a wet cloth to remove any residual cleaning agents.
Utensils and guides	Clean with hot soapy water and a damp cloth. In case of persistent dirt, we recommend prior soaking and the use of a brush.

If the cleaning results are not satisfactory, repeat the cleaning process.

WARNING!

Do not use corrosive, abrasive, or aggressive cleaning agents when cleaning the oven's front panel. Such agents may damage the surface, cause scratches, or permanently alter its appearance.

Automatic oven cleaning – pyrolysis

(depending on the model)

WARNING!

Before manual cleaning, unplug the appliance from the power mains and wait for it to cool down.

Children should not clean the appliance or perform maintenance tasks without proper supervision.

Thanks to the high temperatures, the function allows for easy cleaning of the interior of the appliance. During cleaning, fat residues and other impurities are incinerated and creamated.

Cleaning and maintenance

There are three pyrolysis (cleaning intensity) levels available, with varying duration of the process:

Level	Cleaning purpose	Program duration
Low	For minor impurities	2 h
Medium	For noticeable major impurities	2hrs 30mins
High	For stubborn and persistent (older) impurities	3 h

NOTE: The more stubborn the dirt, the higher the level that should be selected.

Preparing for pyrolytic cleaning

Based on an average oven usage rate, we recommend pyrolytic cleaning once a month.

- Remove all equipment from the oven, including the rack guides.
- Remove all visible dirt and food residue from the oven.
- Only start pyrolytic cleaning when the appliance is cooled.

INFORMATION!

If you are not happy with the cleaning results, we recommend repeating the process.

1.	Turn on the oven. By pressing < or > select CLEANING . Confirm your selection with ✓ .
2.	The display shows three cleaning levels and the duration. Press < or > to select the cleaning level (see table above).
3.	Touch ▷ . Confirm your selection with ✓ .
4.	The oven door locks automatically after a certain time for your safety.
5.	When the program is completed, the information THE DOOR IS LOCKED. THE APPLIANCE IS COOLING DOWN. is retained on the display and a short beep will be emitted.
6.	When the pyrolytic cleaning process is complete and the oven has cooled down, the oven door will be unlocked automatically. Once the oven cavity has fully cooled down, wipe it with hot soapsuds and a soft cloth to remove any residue (e.g. ashes).

Cleaning and maintenance

⚠ WARNING!

During pyrolysis, unpleasant odours and smoke, as well as irritating vapours and gases, may be emitted. Therefore, make sure that the room is well-ventilated during the procedure and do not stay in that room for prolonged periods of time. Do not allow children or pets to come close to the oven.

During the pyrolysis process, food and fat residues may ignite. Therefore, remove all impurities from the oven interior before starting the process.

Appliance exterior will heat up to a high temperature during the pyrolytic cleaning process. Do not touch the oven door and never hang and combustible objects, such as kitchen cloths or towels, on the door handle.

Do not attempt to open the door while it is locked (during pyrolytic cleaning and while the appliance is cooling down after the process)! The cleaning process may be terminated and there is a risk of burns!

Small animals or pets can be particularly sensitive to any fumes. We recommend removing them from the room during the pyrolytic cleaning process and ventilating the room thoroughly once the cleaning process is complete.

Cleaning with steam

This program makes it easier to remove any stains from inside the oven.

The function is the most effective if used regularly, after each use.

Before running the cleaning program, remove all large visible chunks of dirt and food residues from the oven cavity.

⚠ WARNING!

Use the **AQUA CLEAN** system when the oven has fully cooled down.

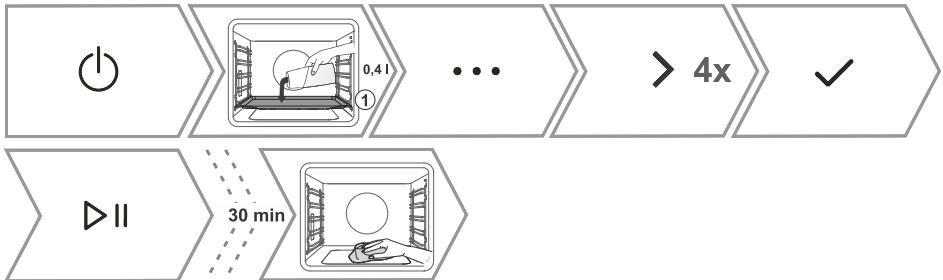

1. Insert the shallow baking tray into the first guide level and pour 0.4 litres of hot water into it.
2. Switch on the appliance and select By touching < or > select **CLEANING**. Confirm with ✓ to enter the submenu.
3. By touching < or > select **AQUA CLEAN**. Confirm with ✓

Table continued from last page

4.	The programme will run for 30 minutes. At the end of the programme, the display will show FINISH .
5.	When the programme is completed, wipe the stains with a wet cloth and soapy water. After cleaning, wipe the appliance thoroughly with a damp cloth to remove any residual cleaning agents. If the cleaning process is not successful (in case of particularly stubborn dirt), repeat it.

Removing wire and fixed pull-out (extendible) guides

Use conventional cleaning products to clean the guides.

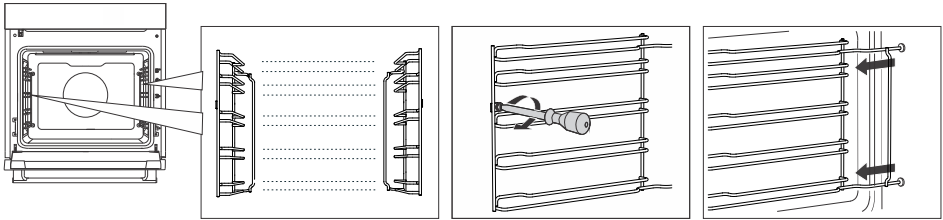

1. Use a screwdriver to remove the screw (you can also use a suitable coin that fits the indentation in the screw head).
2. Remove the guides from the holes in the back wall.

After cleaning, re-tighten the screws on the guides with a screwdriver. When replacing the guides, make sure you mount them on the same side they were installed on prior to removal.

INFORMATION!

When removing the guides, take care not to damage the enamel coating.

Cleaning and maintenance

Removing and replacing the oven door and glass panes

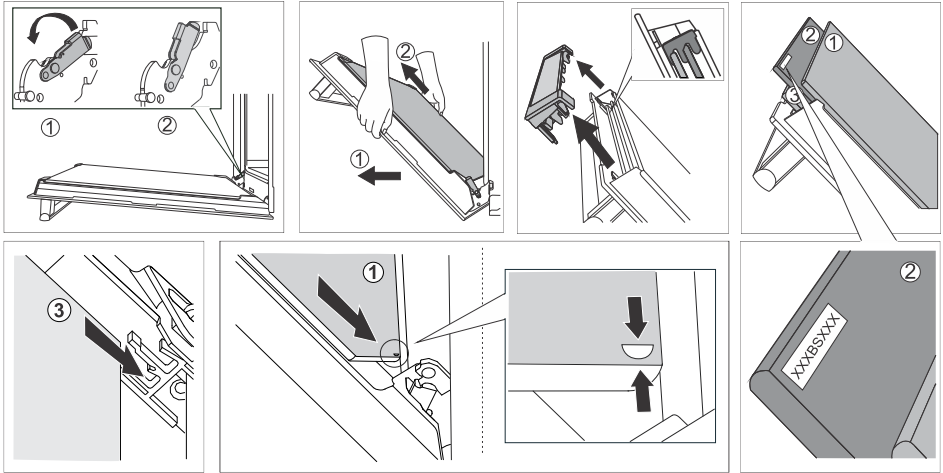

1.	When replacing the oven door, first open the door fully .
2.	Oven door is attached to the hinges with special supports that also include safety levers. Move the safety lever towards the door at an angle of 90°. Gradually close the door to a 45° angle; then lift the door and pull it out.
3.	In order to clean the door windows from the inside, first remove the glass from the appliance door. Follow steps 1 to 4 for the glass removal process, leaving the door in place and not removed from the oven.
4.	Remove the air guide. Hold it on the left- and right-hand side of the door with your hands and slightly pull it towards you to remove it.
5.	When removing the oven door windows, grip the top edge of the glass and remove it carefully. Repeat the same procedure for the second and, if necessary, third glass, depending on the oven model. Ensure that the process is carried out carefully and gently to prevent any damage to the windows or other parts of the oven.
6.	To replace the door glass, use the reverse order. Make sure that the glass is properly aligned and installed safely to ensure the correct operation of the oven. The internal glass panes must be correctly turned when installed. Refer to the inscription on the glass.

In case the door does not open or close properly, make sure the hinges are installed properly.

WARNING!

Always rotate both safety levers towards the support when fitting or removing the appliance door. This is crucial to prevent possible damage, as the door hinge can close with considerable force.

Soft door closing and opening

(depending on the model)

Oven door is fitted with a system that dampens the closing force and allows for easy, quiet and gentle opening and closing of the door. A gentle push to an angle of 15° (relative to the open position of the door) is enough for the door to close softly and automatically.

WARNING!

If the force applied to close the door is too strong, the effect of the system is reduced and the safety mechanism effect is decreased.

Replacing the bulb

The light bulb is a consumable and is not covered by warranty. Before changing the bulb, remove any utensils from the oven.

Halogen lamp: G9, 230 V, 25 W

The oven is fitted with a halogen lamp.

This product contains a light source of energy efficiency class (G).

WARNING!

Only replace the light bulb when the appliance is disconnected from the power supply. Be careful not to damage the enamel. Use protection to avoid burns.

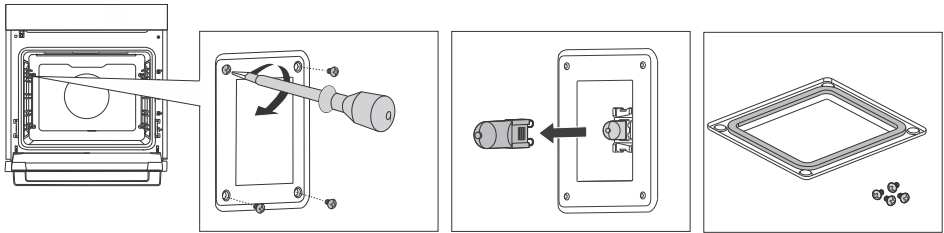

1. Undo the four screws. Remove the cover and the glass.
2. Pull out the halogen bulb (on the left and right) and replace it with a new one.

NOTE: There is a gasket on the lid that should not be removed from the lid. The gasket must fit on the wall of the oven space.

Troubleshooting

During the warranty period, only a service center authorized by the manufacturer may carry out any repairs.

- Before making any repairs, make sure the appliance is disconnected from the power mains either by removing the fuse or by disconnecting the power plug from the wall outlet.
- Any unauthorized repairs of the appliance may result in electric shock and short circuit hazard; therefore, do not perform them. Leave such work to an expert or a service technician.
- In case of minor problems with appliance operation, check this manual to see if you can fix the problem yourself.
- If the appliance is not operating properly or at all due to inappropriate operation or handling, a visit from a service technician shall not be free of charge, even during the warranty period.
- Save the instructions for future reference and pass them on to any subsequent owners or users of the appliance.
- Following is some advice on rectifying some common problems.

Troubleshooting table

Problem/error	Cause
The main fuse in your home trips often.	Call a service technician.
The oven lighting does not work.	The process of changing the light bulb in the oven is described in the chapter Replacing the bulb.
Control unit is not responding, the screen is frozen.	Press and hold the On/Off button for 8 seconds until the screen is reset. Disconnect the appliance from the power mains for a few minutes (undo the fuse or switch off the main switch); then, reconnect the appliance and switch it on.
The display shows the error Err X. In case of a double-digit error code, the display will show Err XX.	There is an error in the electronic module operation. Disconnect the appliance from the power mains for a few minutes. If the error is still indicated, call a service technician.
The display shows Cooking with food probe, but the probe is not connected.	Clean the socket. Try to connect and disconnect the food probe several times in succession.
Condensate accumulation on the inner side of the glass.	This phenomenon is normal when cooking food with a large amount of liquid, e.g. potatoes, cottage cheese, etc. Allow the glass to cool down after use, then clean the remaining drops.

If the problems persist despite observing the above advice, call an authorized service technician. Repair or any warranty claim resulting from incorrect connection or use of the appliance shall not be covered by the warranty. In this case, the user will cover the cost of repair.

Label – appliance information

A rating plate with basic information about the appliance is attached to the edge of the oven. Precise information on appliance type and model can also be found on the warranty sheet.

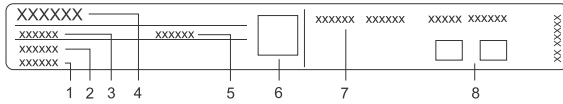

- | | |
|------------------|------------------------------|
| 1. Serial number | 5. ID/code |
| 2. Model | 6. QR code |
| 3. Type | 7. Technical information |
| 4. Brand | 8. Compliance labels/symbols |

Compliance information

Radio equipment type:	Built-in WiFi/BLE module
Wi-Fi indicator	
Operating frequency range:	2412 ~ 2472 MHz
Maximum output power:	19.99 dBm EIRP
Maximum antenna gain:	3.26 dBi
Bluetooth indicator	
Frequency range:	2402 ~ 2480 MHz
Carrier Output:	10.00 dBm
Emission type:	F1D

The company declares that the device with the function Connectlife complies with the essential requirements and other relevant provisions of Directive 2014/53/EU. The detailed Declaration of Conformity can be found at the web address <https://auid.connectlife.io> on the page of your device among the additional documents.



INFORMATION!

The project uses the LVGL graphics library as its graphical user interface.



Our product packaging is made of environmentally friendly materials that can be recycled, disposed of, or destroyed without any hazard to the environment. To this end, packaging materials are labelled appropriately.

The symbol on the product or its packaging indicates that the product should not be treated as normal household waste. Take the product to an authorized collection centre for waste electric and electronic equipment processing.

Correct **disposal** of the product will help prevent any negative effects on the environment and health of people, which could occur in case of incorrect product removal. For detailed information on removal and processing of the product, please contact the relevant municipal body in charge of waste management, your waste disposal service, or the store where you bought the product.

We reserve the right to any changes and errors in the instructions for use.

Cooking test

EN60350-1: Only use equipment supplied by the manufacturer.

Always insert the baking tray all the way to the end position on the wire guide. Place pastry or cakes baked in moulds as shown in the image.

* Preheat the appliance until it reaches the set temperature. Do not use the rapid preheat mode.

** Preheat the appliance for 5 minutes. Do not use the rapid preheat mode.

*** Preheat the appliance for 10 minutes. Do not use the rapid preheat mode.

1) Turn after 2/3 of cooking time.



















BAKING							
Dish	Equipment	mould placement	 cm		°C	⌚ min	
shortbread – single rack	shallow baking tray		60	3	130**	35-45	—
			45	2	140	35-45	—
shortbread – single rack	shallow baking tray		60	3	140-150	30-40	
			45	2	140	40-50	
shortbread – two racks/levels	shallow baking tray		60	2,4	135***	35-45	
			45	1,3	140	40-55	
small cakes – single rack	shallow baking tray		60	3	160-170***	20-30	—
			45	2	160-170	25-35	—
small cakes – single rack	shallow baking tray		60	3	150-160**	25-35	
			45	2	160-170***	25-35	
small cakes – two racks/levels	shallow baking tray		60	2,4	140	30-40	
			45	1,3	160-170	40-50	
sponge cake	round metal mould, diameter 26 cm/wire rack		60	1	160***	25-35	—
			45	2	160***	25-35	—
sponge cake	round metal mould, diameter 26 cm/wire rack		60	3	170-180**	25-35	
			45	1	165	25-35	
apple pie	2 x round metal mould, diameter 20cm/wire rack		60	1	160-170***	70-90	—
			45	1	170-180***	70-90	—

Table continued from last page

BAKING							
apple pie	2 × round metal mould, diameter 20cm/wire rack		60	3	175	70-90	
			45	2	170-180	70-90	
BROILING							
toast	wire rack		60/45	5	max	5-15	
Burgers ¹⁾	wire rack + shallow baking sheet as drip tray		60/45	4	max	30-45	

 **ASKO**



946761-a5

CE